

Hypro

Architectural

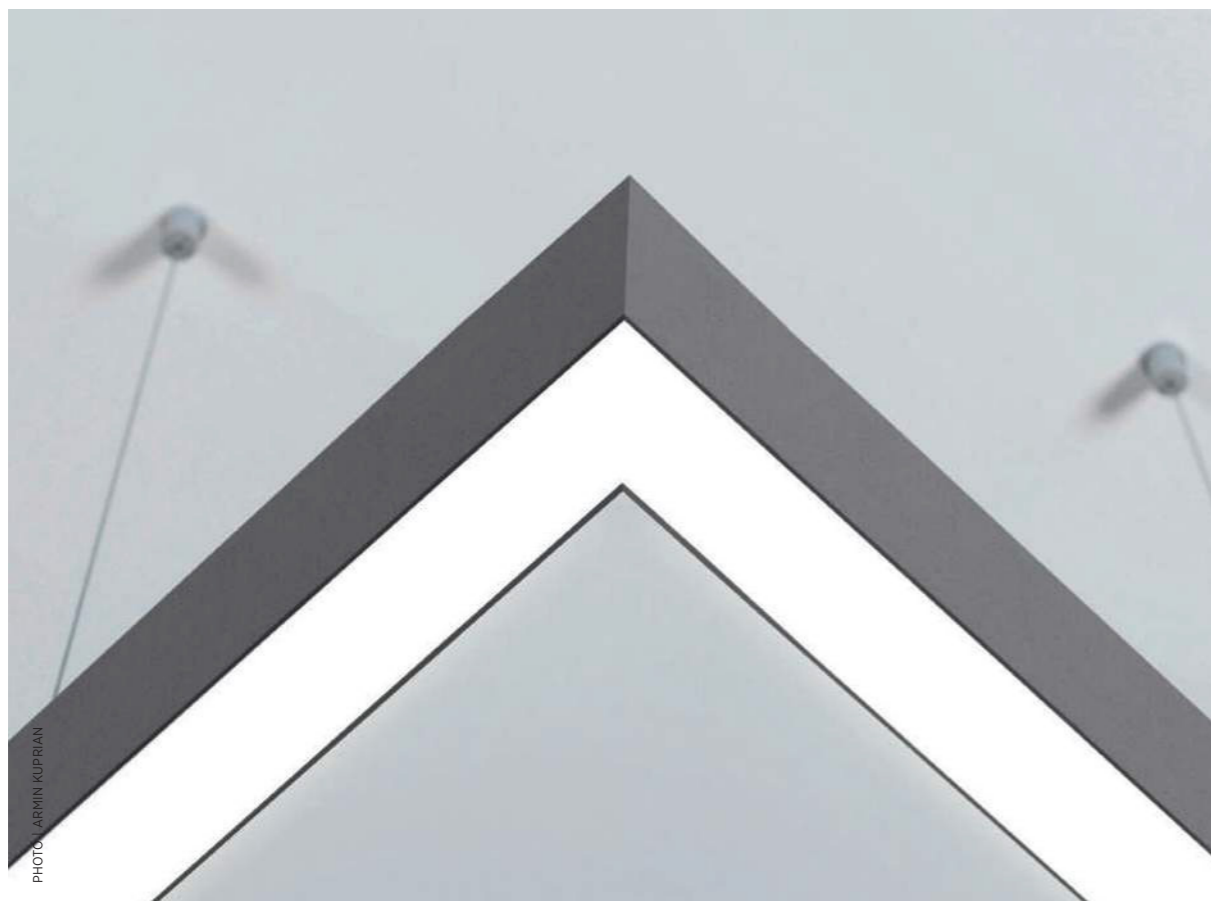

PHOTO | ARMIN KUPRIAN

YOUR PROJECT
MAKES YOUR PRODUCT



OVERVIEW
HYPRO FAMILY



DRAW YOUR LINE

HYPRO is a multifunctional profile system, individually configurable and adaptable to any room situation. With different L, T and X connectors, the system can be guided through the room as desired and take on any individual shape. With this freedom, the lighting can adapt perfectly to the interior design and structure of the room. Optionally, the connectors can also be equipped with light sources to achieve a seamless look.

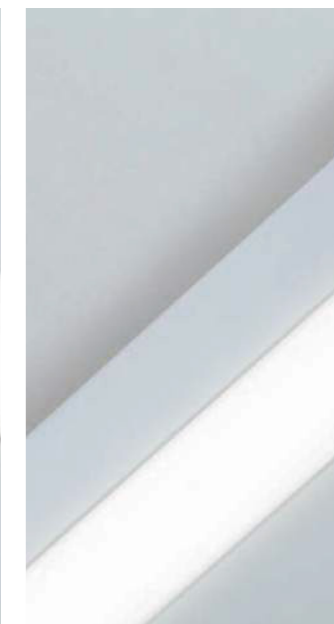



PHOTO | ARMIN KUPRIAN



RECESSED



SURFACE

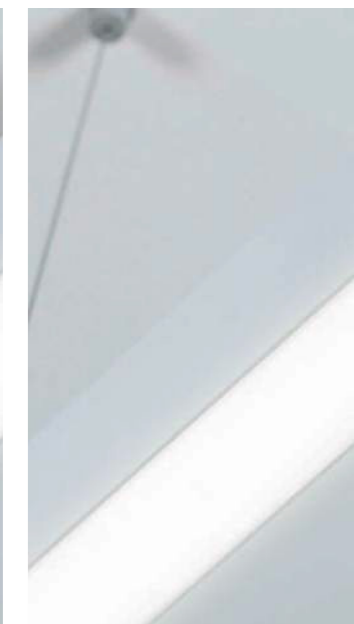

SUSPENDED

MOUNTING OPTIONS

Thanks to different mounting options, the system enables a perfect integration of the lighting solution into the room concept. Whether recessed, surface-mounted or suspended version, the Hypro lighting system offers you the variant you need for your project.

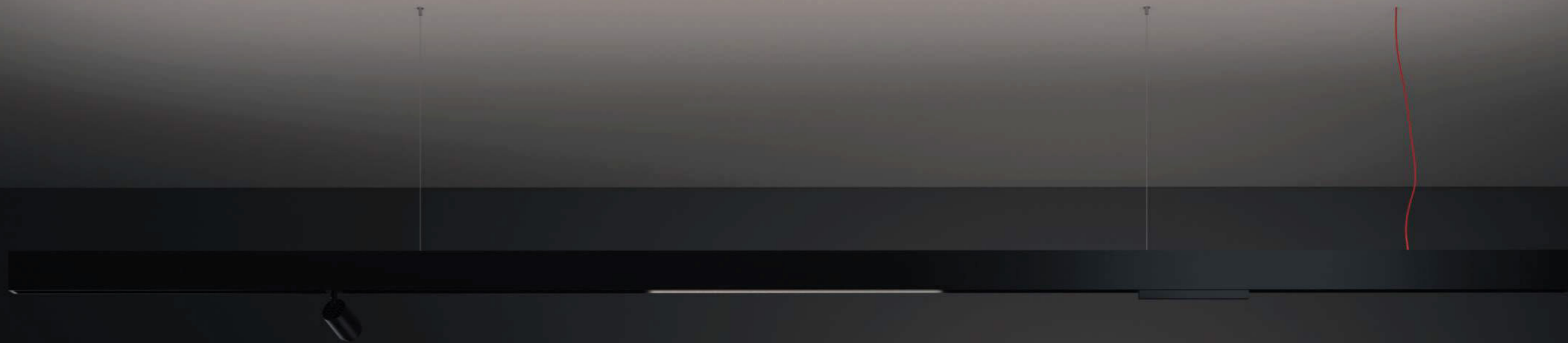

BATWING LENS

The new wide-beam indirect lens developed by PROLICHT enables further possibilities to create the desired lighting atmosphere. Even in low rooms, a very homogeneous light pattern can now be achieved thanks to the very wide-beam indirect lens.

Ideal for use in office lighting to achieve the desired and required uniformity. The sophisticated development of the lens allows it to be used with TUNABLE WHITE inserts. Homogeneous color mixing and consistent light quality is guaranteed even with TUNABLE WHITE applications.

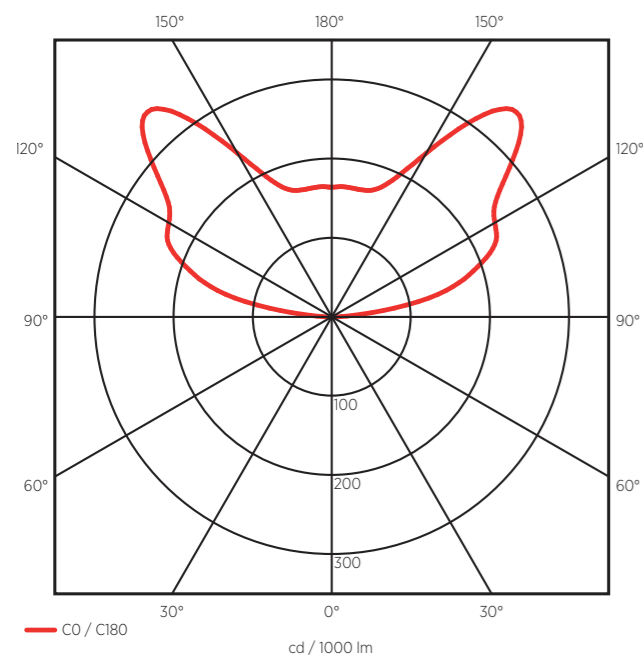

The Indirect Lens is available for our HYPRO-X Profile Luminaire, HYPRO-F Floor Luminaire as well as for our HADI Area Luminaire.

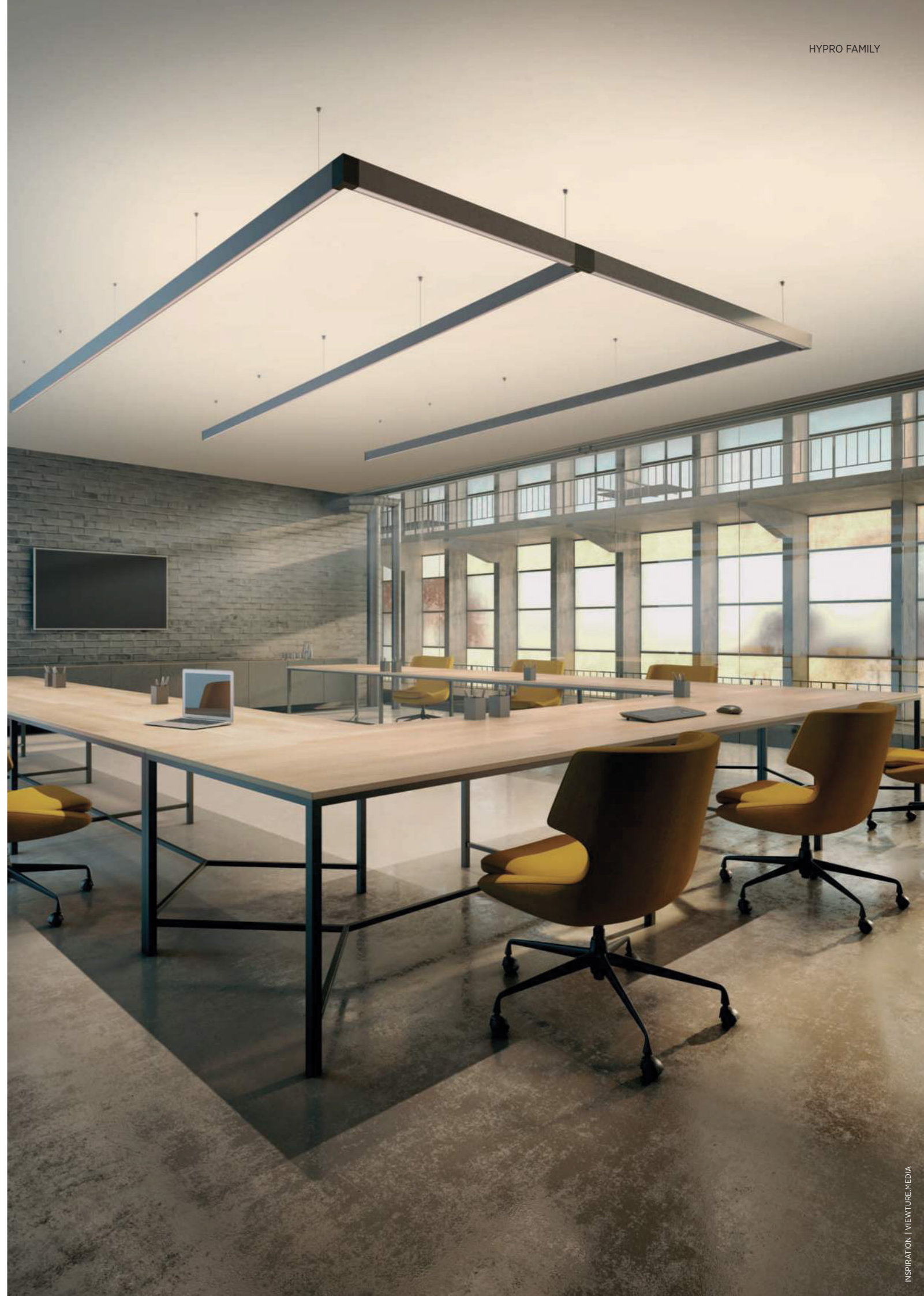
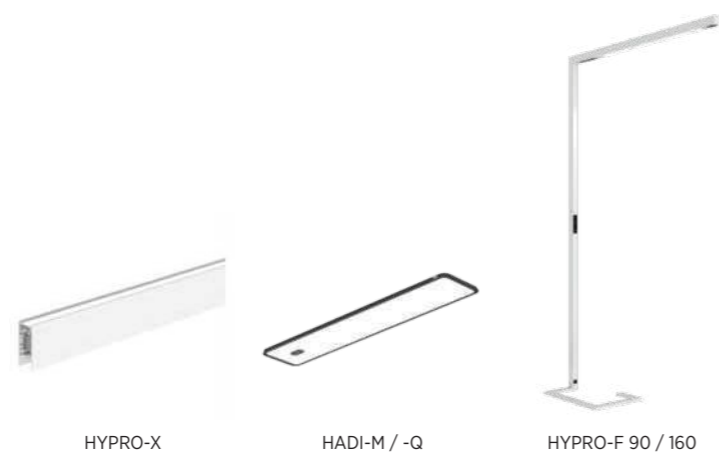

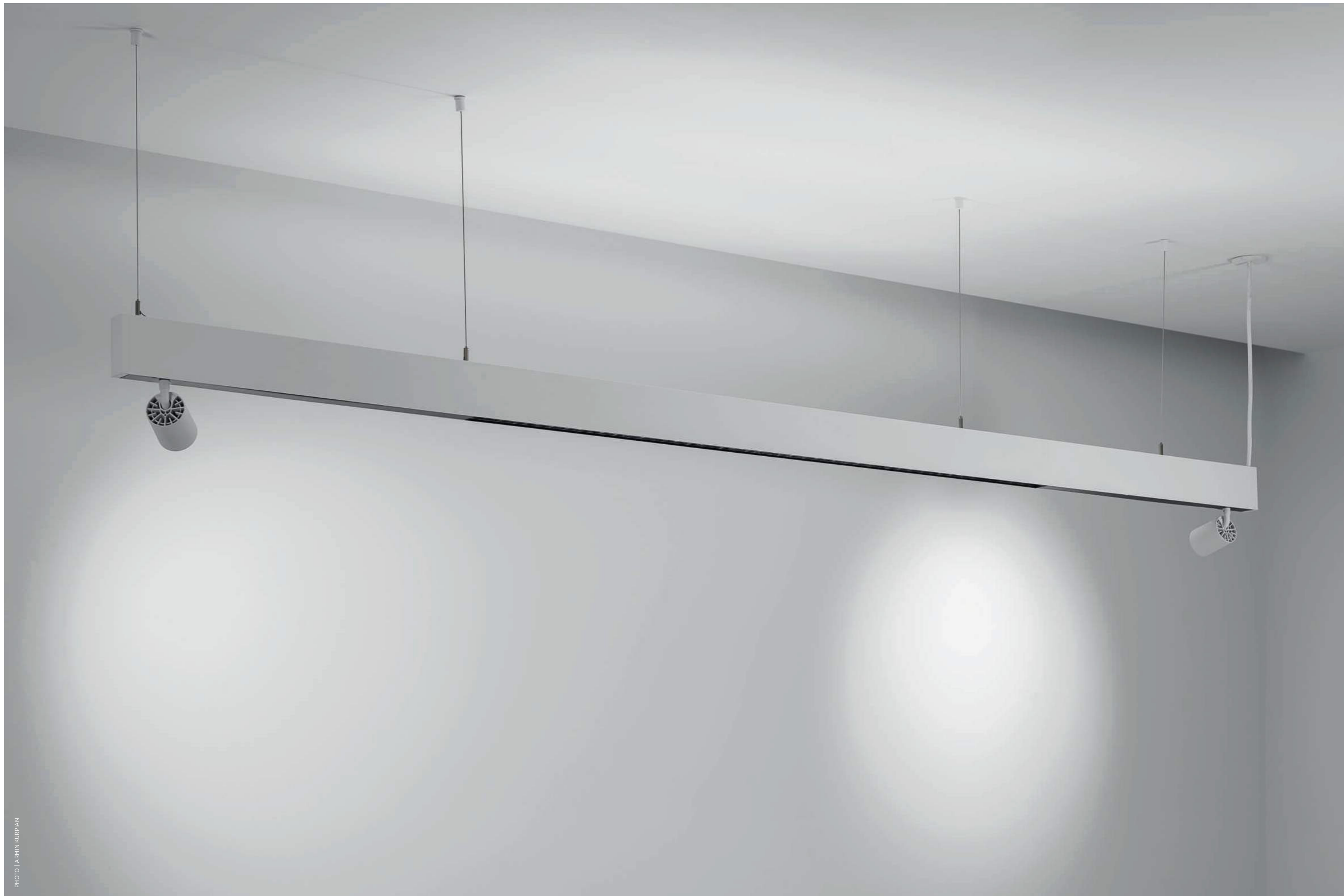
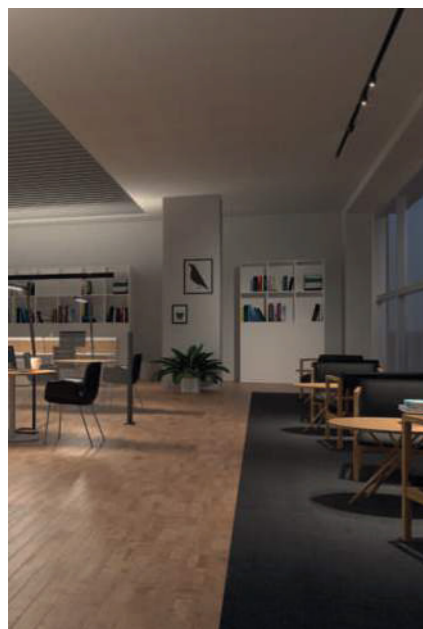

PHOTO | ARMIN KURPIAN

HYPRO-X | PROFILE: COLOR 03 CRYSTAL WHITE | CENTRIQ IN: COLOR 03 CRYSTAL WHITE | HYPRO-X LINE RICO TUNABLE WHITE



TUNABLE WHITE

Tunable white is the perfect choice for an installation capable of adapting to the needs of human beings, mimicking the evolution of natural light during the day, or defining with specific settings the most comfortable scenario that each user can define.

Tunable white is available on all functions offered within the HYPRO family: direct and indirect linear lights, spotlights and Rico modules.

According to the defined control system, any installation can be controlled with a unique temperature, or managing each module individually.



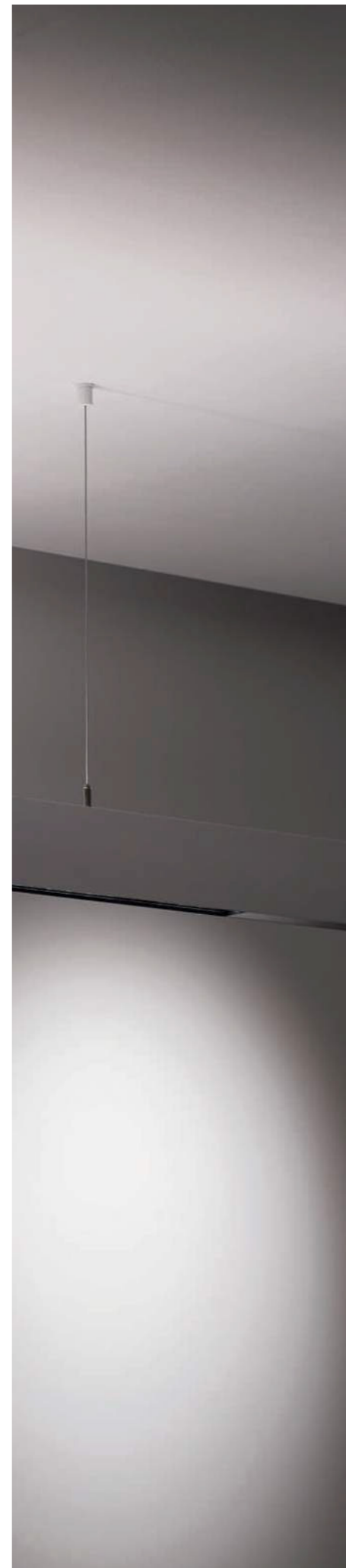

PHOTO | ARMIN KURPIAN

HYPRO-X | PROFILE: COLOR 03 CRYSTAL WHITE | CENTRIQ IN: COLOR 03 CRYSTAL WHITE | HYPRO-X LINE RICO TUNABLE WHITE

ENDLESS POSSIBILITIES

HYPRO creates unique new levels of lighting structure. The individually configurable HYPRO system is available in recessed, surface-mounted and pendant versions and can be equipped with inserts for general and accent lighting.

Various of our proven product families can be integrated into the HYPRO system, offering you endless combination possibilities.



MICRO PRISM OR
OPAL DIFFUSOR



RICO LED LINE

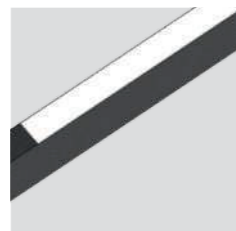

INDIRECT OPAL
DIFFUSER



CENTRIQ SINGLE OR
DOUBLE IN 3 SIZES



MAGIQ 4, 4+4, 8 OR 8+8
WITH KORONA VER-
SIONS



MAGIQ MICRO DOT
WITH LFO-LENS



MAGIQ WALLWASH



MAGIQ HOLLOW

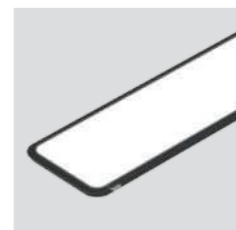

HADI-M WITH /
WITHOUT SENSOR

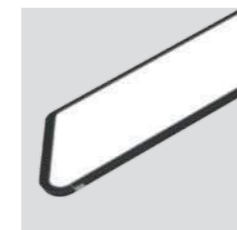

HADI-Q WITH /
WITHOUT SENSOR



SNOOKER



HANGOVER PLUG



SIGN DIVA TUBE

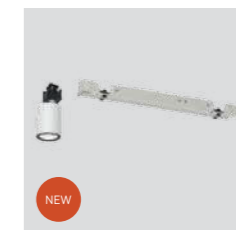

CENTRIQ IN

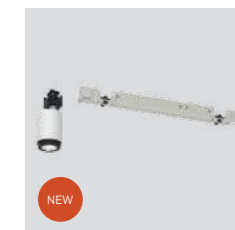

OIKO PRO IN



WHITE HOUSES | PHOTO: EUGENI PONS | WWW.EUGENIPONS.COM



HYPRO-X RICO

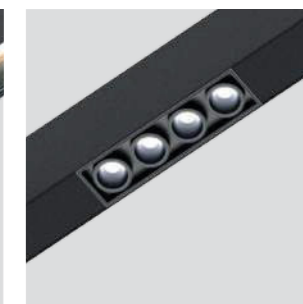

MAGIQ 4

BEST IN OFFICE

Its unique functions and combination possibilities make HYPRO a highly comprehensive lighting solution that can meet any requirement, especially in complex situations such as office lighting.

To offer the best lighting for workplaces, HYPRO can be customized and equipped with different inserts to ensure that the lighting concept meets all required standards. The track of the HYPRO profile can be adapted to the conditions of a room in the simplest and at the same time most individual way.

Equipped with the innovative Rico reflectors, this system achieves the highest efficiency with a unique glare-free.

With additional inserts such as the MAGIQ family, homogeneous workplace illumination is guaranteed, and with the integration of an uplight component for indirect ceiling lighting, this product family offers the optimum prerequisites for fulfilling all the required standards for workplace lighting.



THE NEXT STEP IN HUMAN CENTRIQ LIGHTING

Shapes play a big role in architecture. They can change the atmosphere of an entire room. The combination of optimal lighting conditions and a design of the luminaires that is based on the interior concept gives the rooms a special flair. Therefore, products within a product family have a consistent design to create a unified concept or coherently expand an existing one.

Distinctive design and a wide range of different technical advantages characterize our HYPRO FAMILY. The basic proportions and the familiar appearance of the successful system family are taken up in every innovation of this family, so that every component and every product of this family can be homogeneously combined for a multi-functional lighting solution.

A new component is now available for HYPRO-X and HYPRO-F to extend the products indirect lighting capabilities. The extremely wide beam characteristic of the lens creates a continuous homogeneous light pattern on the ceiling and thus raises illumination to a new level. The new lens is available in the common light temperatures (3000K and 4000K) and can also be configured in TUNABLE WHITE for even greater flexibility.

The direct component of our HYPRO-F free-standing luminaire can now also be equipped with TUNABLE WHITE - the revised RICO reflectors with a micro prismatic cover produce direct light with infinitely variable color temperature control. As a result, the entire luminaire is now directly as well as indirectly configurable in TUNABLE WHITE.



The revolutionary Tunable Focus technology from PROLICHT allows any combination of soft direct lighting (LED line), hard direct lighting (downlight spots) and indirect ceiling lighting.







HADI OFFICE LIGHTING REINVENTED

The HADI luminaire is the ideal choice for office spaces, offering a variety of solutions for diverse applications: large or smaller spaces, multifunctional spaces, from single offices to open space lighting grids – with HADI every office project can be illuminated perfectly. Available the luminaire in two forms - HADI-M and HADI-Q and thus meets all the requirements that modern interior design places on the designer and works with the latest technology. This makes the product family the perfect solution for office spaces where flexible lighting is essential.

Thanks to its outstanding efficiency of up to 87%, a single HADI luminaire can illuminate two work desks, minimizing power consumption for the desired lighting level.

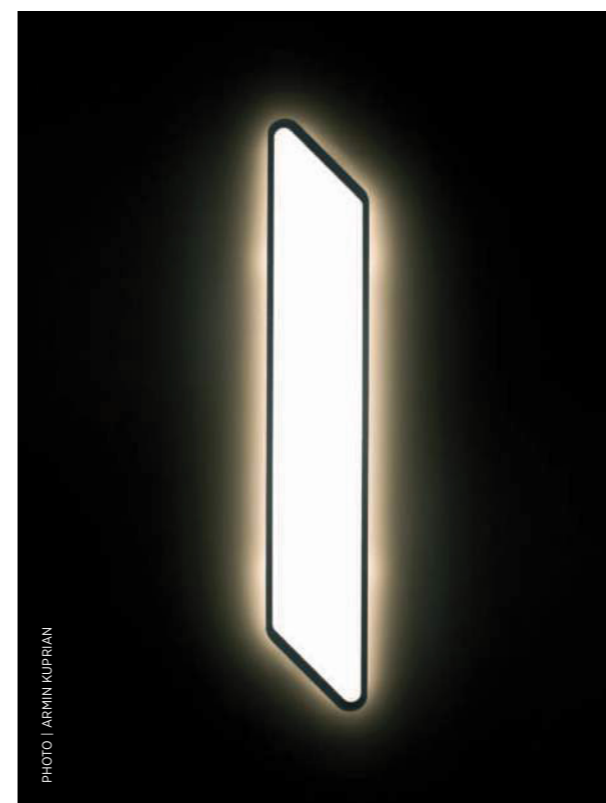

HADI-Q

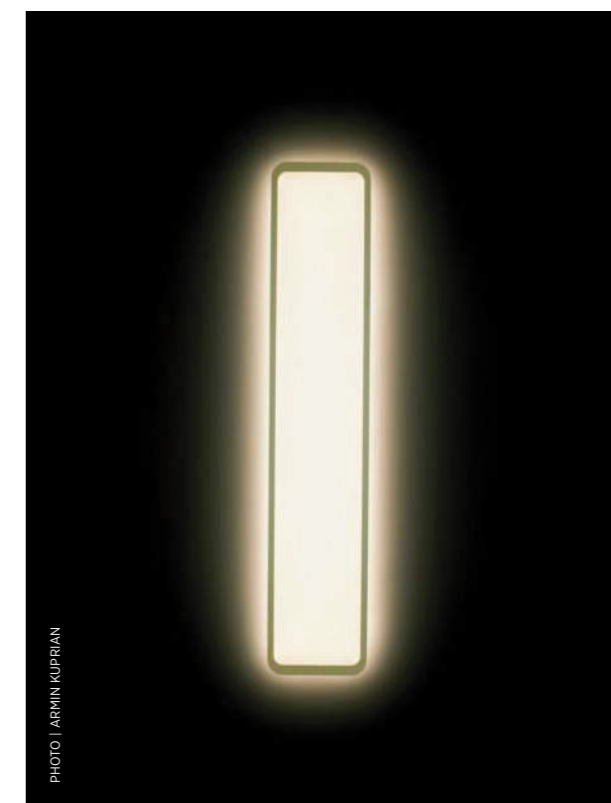

HADI-M



AMBAUTALLER D'ARQUITECTES @AMBAU_TDA | PHOTO: @GERMAN CABO GERMANCABO.COM

FOLLOW THE LIGHT

A lighting concept specially adapted to the conditions of a room can, in addition to the optimal lighting of a room, contribute to orientation and structuring. Especially with different freely integrable profile inserts such as Wallwasher, spots and LED inserts can be consciously supported guidance, attention and atmosphere. These possibilities are offered to perfection by the hybrid profiles that can be individually configured in the room and make HYPRO a master of flexibility for ambient and accent lighting.



OIKO PRO IN



MAGIQ WALLWASH





OIKO PRO IN



SIGN

SIGN DIVA TUBE

SIGN DIVA as an insert for the HYPRO profile system creates new possibilities in interior design. With their sophisticated technology and a flexible swivel system, the minimalist surface luminaires offer the ideal complement for the portfolio of pendant inserts, spotlights and spots.



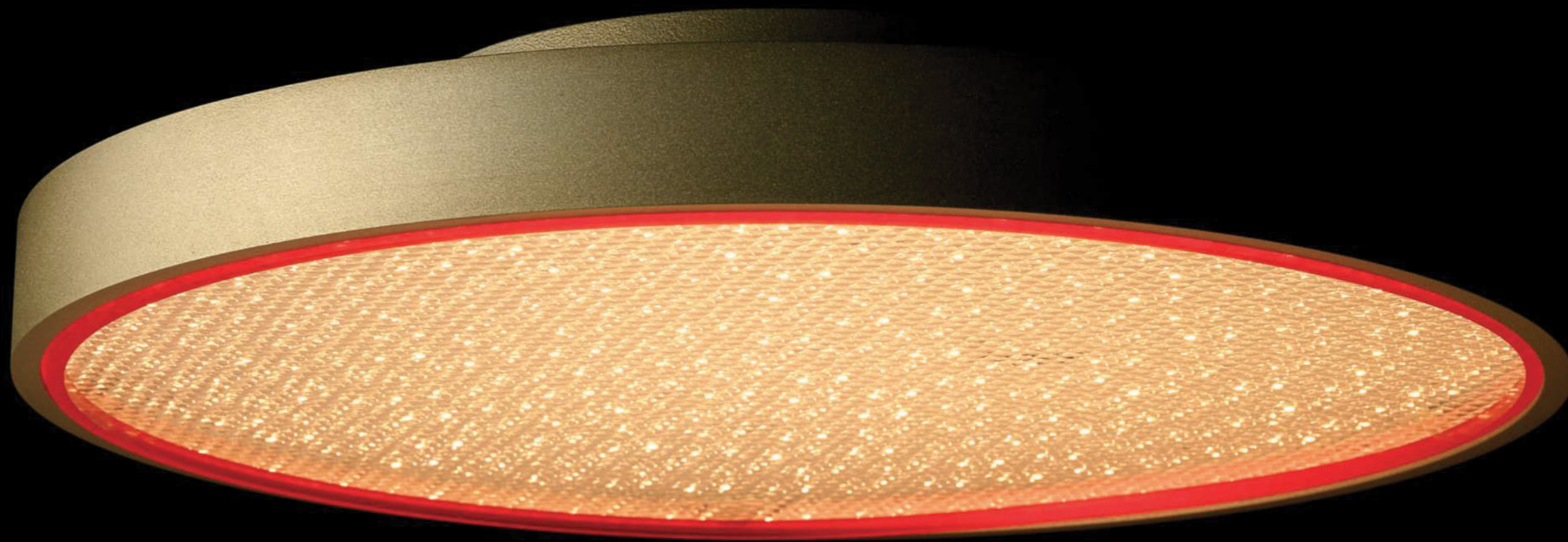

PHOTO | ARRIN KURPIAN



PHOTO | ARMIN KUPRIAN



PHOTO | ARMIN KUPRIAN

SNOOKER

Besides the optimal lighting conditions, the decorative aspect also plays a major role in many room situations. This can significantly change the atmosphere of an entire room. The combination of optimal lighting conditions and a look of the lights, which is oriented to the interior design, gives the rooms a special flair. Individual placement of several pendant luminaires in the HYPRO profile, provides a homogeneous illumination.



RODESARCHITECTURA @RODES_ARCHITECTURA | PHOTO: @GERMAN CABO GERMANCABO.COM

HYPRO-X | PROFILE: COLOR 02 BLACK VELVET | SNOOKER SHINE: COOLOR 02 BLACK VELVET, SHINE RING: WHITE



CREATE ATMOSPHERE



The HANGOVER pendant luminaire is based on the latest reflector technology and offers great configuration possibilities. Whether size, color or LED of an individual design are no limits.



To ensure flexible positioning of the spotlights, the driver is connected to a plug and not permanently installed. This allows the track spots to be positioned exactly where highlights are to be staged in the room.



PHOTO | ARMIN KUPRIAN



SCHLOSS BURGDORF, SWITZERLAND | ARCHITECT: ATELIER G+S, ARCHITECTEN UND PLANNER AG | LIGHT PLANNING: BEZNIER HOLMES UND PARTNER | PHOTO: VERENA MENZ, BURGDORF

HYPRO FAMILY

MOUNTING OPTIONS



RECESSED



SURFACE

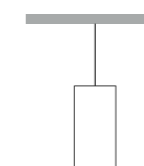

SUSPENDED



FLOOR LAMP

CONFIGURATION



STRAIGHT

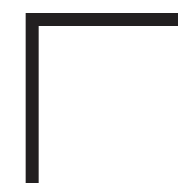

CORNER



HYPLINE-40

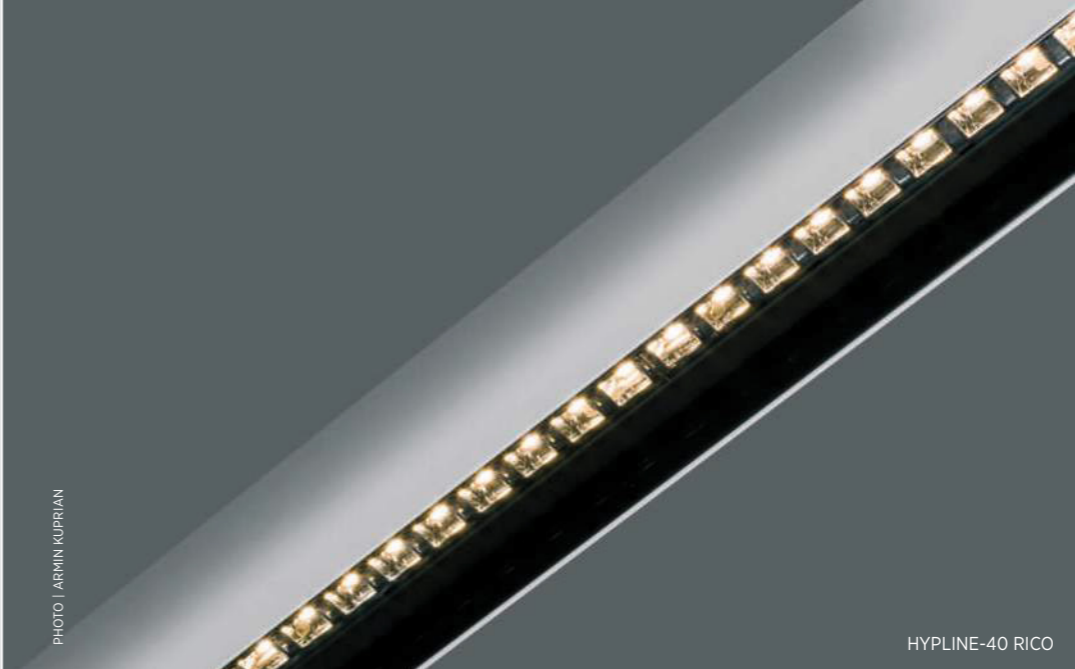
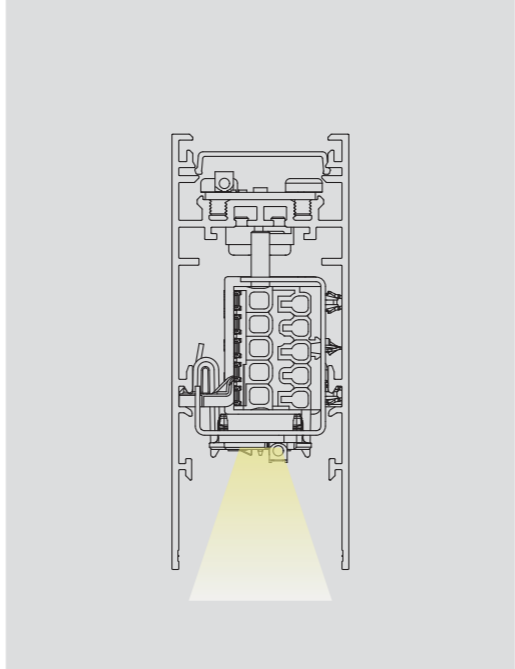

HYPLINE-40 RICO

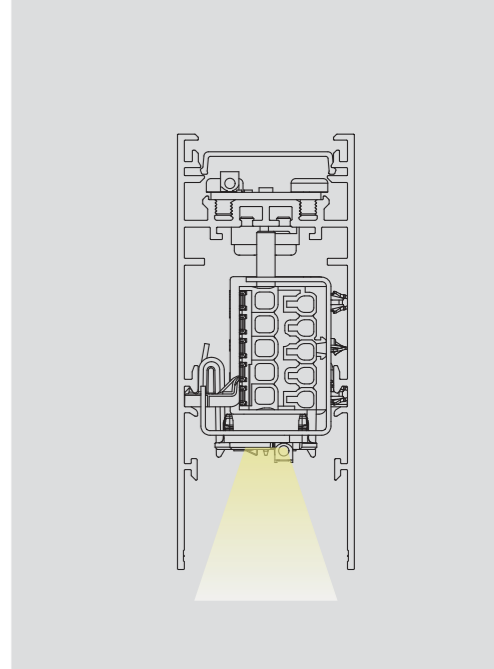

POWER

17 - 37 WATT

IP International Protection

IP20

COLOR TEMPERATURE CCT

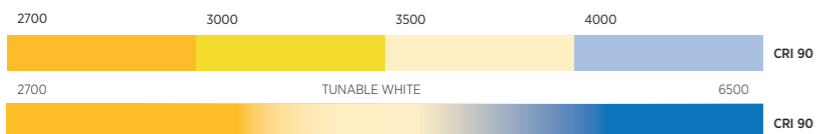

BEAMWIDTH

DIRECT



HYPLINE-40

PRODUCT	DIMENSIONS	CCT				LUMEN MAX.	WATT	CRI	IP
		2700	3000	3500	4000				
HYPLINE-40	L 705 mm	2700	3000	3500	4000	1365	17	90	IP20
HYPLINE-40	L 705 mm	TUNABLE WHITE 2700 - 6500				1508	19	90	IP20
HYPLINE-40	L 1128 mm	2700	3000	3500	4000	2183	26	90	IP20
HYPLINE-40	L 1128 mm	TUNABLE WHITE 2700 - 6500				2413	29	90	IP20
HYPLINE-40	L 1408 mm	2700	3000	3500	4000	2729	33	90	IP20
HYPLINE-40	L 1408 mm	TUNABLE WHITE 2700 - 6500				3016	37	90	IP20

POWER

17 - 33 WATT

IP International Protection

IP20

COLOR TEMPERATURE CCT

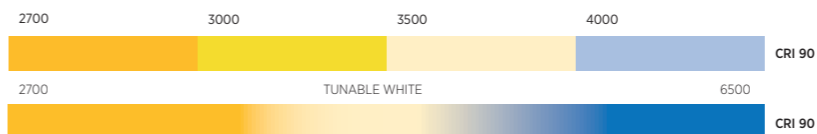

BEAMWIDTH

DIRECT



HYPLINE-40 RICO

PRODUCT	DIMENSIONS	CCT				LUMEN MAX.	WATT	CRI	IP
		2700	3000	3500	4000				
HYPLINE-40	L 705 mm	2700	3000	3500	4000	1746	17	90	IP20
HYPLINE-40	L 705 mm	TUNABLE WHITE 2700 - 6500				1930	19	90	IP20
HYPLINE-40	L 1128 mm	2700	3000	3500	4000	2794	26	90	IP20
HYPLINE-40	L 1128 mm	TUNABLE WHITE 2700 - 6500				3087	30	90	IP20
HYPLINE-40	L 1408 mm	2700	3000	3500	4000	3492	33	90	IP20
HYPLINE-40	L 1408 mm	TUNABLE WHITE 2700 - 6500				3833	36	90	IP20



PHOTO | ARMIN KUPRIAN

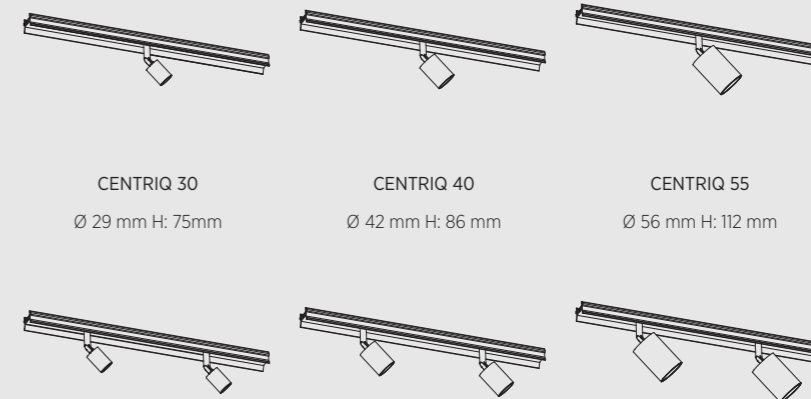

CENTRIQ 30
Ø 29 mm H: 75 mm

CENTRIQ 40
Ø 42 mm H: 86 mm

CENTRIQ 55
Ø 56 mm H: 112 mm

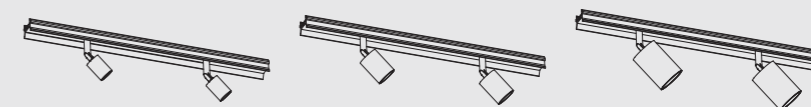

CENTRIQ DOUBLE 30

CENTRIQ DOUBLE 40

CENTRIQ DOUBLE 55

POWER

5 - 25 WATT

IP International Protection

IP20

COLOR TEMPERATURE CCT



BEAMWIDTH



COLOR

25 PROLIGHT COLORS



RAL Classic or any other color on request

CENTRIQ

PRODUCT	DIMENSIONS		CCT			LUMEN MAX.	WATT	CRI	BEAM ANGLE						IP	
CENTRIQ	Ø 29 mm	H: 74 mm	2700	3000	4000	302	5	90	24°	32°						IP20
CENTRIQ	Ø 42 mm	H: 86 mm	2700	3000	4000	575	7	90	20°	31°	36°	40°	50°		IP20	
CENTRIQ	Ø 42 mm	H: 86 mm	2700	3000	4000	433	7	90	SUPERSPOT 11°						IP20	
CENTRIQ	Ø 56 mm	H: 112 mm	2700	3000	4000	953	13	90	15°	17°	25°	33°	35°	46°	IP20	
CENTRIQ	Ø 56 mm	H: 112 mm	2700	3000	4000	553	10	90	SUPERSPOT 11°						IP20	

CENTRIQ DOUBLE

PRODUCT	DIMENSIONS		CCT			LUMEN MAX.	WATT	CRI	BEAM ANGLE						IP
CENTRIQ	Ø 29 mm	H: 74 mm	2700	3000	4000	605	9	90	24°	32°					IP20
CENTRIQ	Ø 42 mm	H: 88 mm	2700	3000	4000	1151	14	90	20°	31°	36°	40°	50°		IP20
CENTRIQ	Ø 42 mm	H: 88 mm	2700	3000	4000	867	13	90	SUPERSPOT 11°						IP20
CENTRIQ	Ø 56 mm	H: 112 mm	2700	3000	4000	1906	25	90	15°	17°	25°	33°	35°	46°	IP20
CENTRIQ	Ø 56 mm	H: 112 mm	2700	3000	4000	1105	19	90	SUPERSPOT 11°						IP20

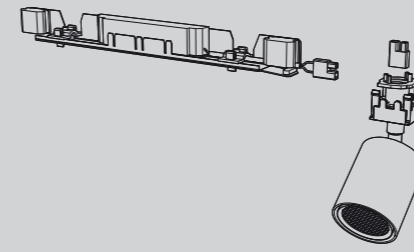

CENTRIQ IN 65

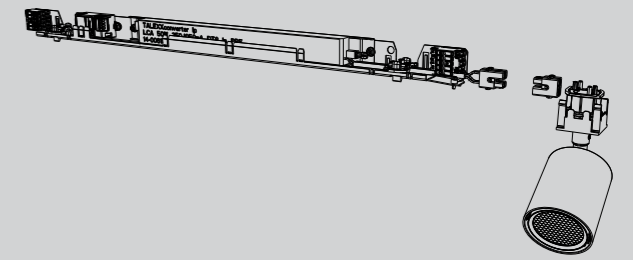

CENTRIQ IN 65 | TUNABLE WHITE

POWER

9 - 36 WATT

IP International Protection

IP20

INSTALLATION

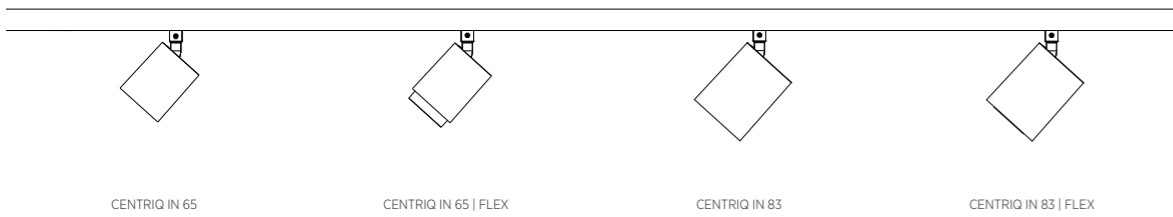

COLOR TEMPERATURE CCT

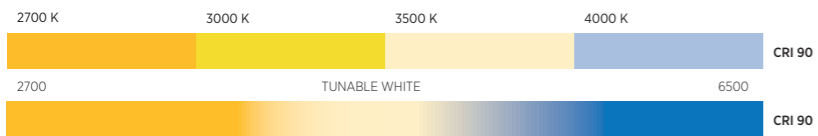

BEAMWIDTH



COLOR

25 PROLICHT COLORS



RAL Classic or any other color on request

CENTRIQ IN

PRODUCT	CCT				LUMEN MAX.	WATT	CRI	BEAM ANGLE				IP
CENTRIQ IN 65	2700	3000	3500	4000	2291	23	90	SPOT 24°	MEDIUM 36°	WIDE FLOOD 52°	IP20	
CENTRIQ IN 65	TUNABLE WHITE 2700 - 6500				1269	15	90	SPOT 24°	MEDIUM 36°	WIDE FLOOD 52°	IP20	
CENTRIQ IN 65	FLEX	2700	3000	3500	4000	1423	21	SPOT 14° - MEDIUM 44°			IP20	
CENTRIQ IN 65		2700	3000	3500	4000	1557	21	SUPERSPOT 12°			IP20	
CENTRIQ IN 65		TUNABLE WHITE 2700 - 6500				569	9	SUPERSPOT 12°			IP20	
CENTRIQ IN 83	2700	3000	3500	4000	3450	36	90	SPOT 20°	MEDIUM 32°	WIDE FLOOD 54°	IP20	
CENTRIQ IN 83		TUNABLE WHITE 2700 - 6500				2907	36	90	SPOT 20°	MEDIUM 32°	WIDE FLOOD 54°	IP20
CENTRIQ IN 83	FLEX	2700	3000	3500	4000	1423	21	SPOT 14° - MEDIUM 44°			IP20	
CENTRIQ IN 83	FLEX	TUNABLE WHITE 2700 - 6500				664	9	SPOT 14° - MEDIUM 44°			IP20	
CENTRIQ IN 83		2700	3000	3500	4000	1843	27	SUPERSPOT 12°			IP20	
CENTRIQ IN 83		TUNABLE WHITE 2700 - 6500				569	9	SUPERSPOT 12°			IP20	



A
0-90°

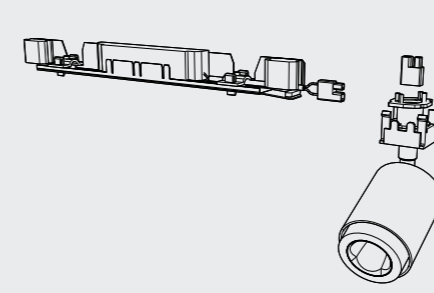

OIKO PRO IN

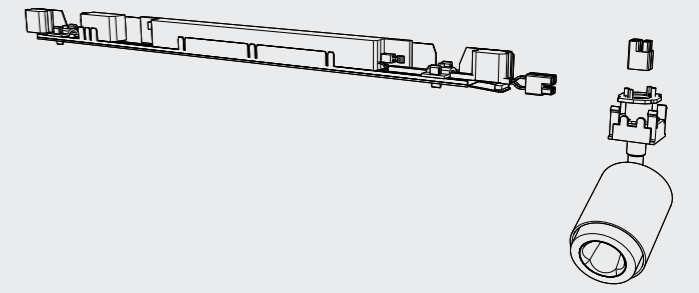

OIKO PRO IN | TUNABLE WHITE

POWER

15 - 20 WATT

IP International Protection

IP20

Installation

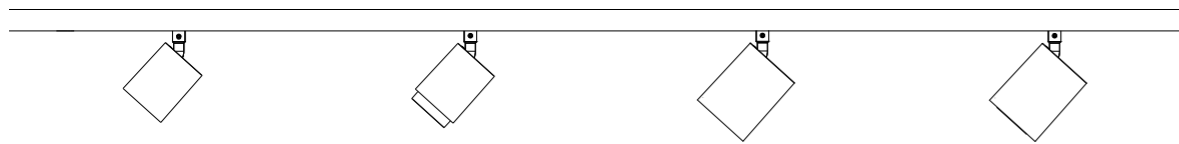

COLOR TEMPERATURE CCT

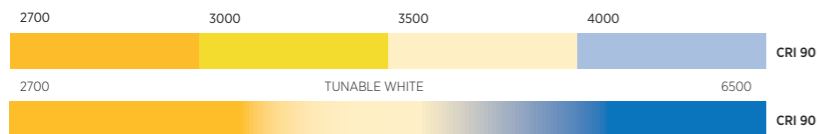

BEAMWIDTH



COLOR

25 PROLICHT COLORS



RAL Classic or any other color on request

OIKO PRO IN

PRODUCT	CCT				LUMEN MAX.	WATT	CRI	BEAM ANGLE		IP
OIKO PRO IN	2700	3000	3500	4000	1603	20	90	MEDIUM	34°	IP20
OIKO PRO IN	TUNABLE WHITE 2700 - 6500				1081	15	90	MEDIUM	36°	IP20
OIKO PRO IN	2700	3000	3500	4000	1759	20	90	WIDE FLOOD	50°	IP20
OIKO PRO IN	TUNABLE WHITE 2700 - 6500				1070	15	90	WIDE FLOOD	52°	IP20
OIKO PRO IN	2700	3000	3500	4000	1932	20	90	VERY WIDE FLOOD	60°	IP20
OIKO PRO IN	2700	3000	3500	4000	1460	15	90	VERY WIDE FLOOD	68°	IP20
OIKO PRO IN	2700	3000	3500	4000	1724	20	90	WALLWASH		IP20
OIKO PRO IN	TUNABLE WHITE 2700 - 6500				1213	15	90	WALLWASH		IP20
OIKO PRO IN	2007	3000	3500	4000	1461	20	90	SUPERSPOT	14°	IP20



PHOTO | ARMIN KUPRIAN

SNOOKER

SNOOKER METAL

PHOTO | ARMIN KUPRIAN

CAN-HAVE ACCESSORY: SHINE RING

WHITE YELLOW ORANGE RED BLUE GREEN



COLOR TEMPERATURE CCT

2700 K 3000 K 4000 K



BEAMWIDTH

MEDIUM 32° up to VERY WIDE FLOOD 58°



SNOOKER (not available for SNOOKER METAL)

25 PROLICHT COLORS



RAL Classic or any other color on request

SNOOKER

PRODUCT	CCT			LUMEN MAX.	WATT	CRI	BEAM ANGLE			IP	
SNOOKER	2700	3000	4000	356	6.4	90	MEDIUM	32°	VERY WIDE FLOOD	58°	IP20

SNOOKER METAL (CHROME)

PRODUCT	CCT			LUMEN MAX.	WATT	CRI	BEAM ANGLE			IP	
SNOOKER METAL	2700	3000	4000	356	6.4	90	MEDIUM	32°	VERY WIDE FLOOD	58°	IP20
SNOOKER METAL SHINE	2700	3000	4000	356	6.4	90	MEDIUM	32°	VERY WIDE FLOOD	58°	IP20

PRODUCT
HYPRO PLUG ADAPTER

CAN-HAVE ACCESSORY: SHINE RING

WHITE YELLOW ORANGE RED BLUE GREEN



COLOR TEMPERATURE CCT

2700 K 3000 K 4000 K



BEAMWIDTH

SPOT 22° up to VERY WIDE FLOOD 66°



COLOR

25 PROLICHT COLORS



RAL Classic or any other color on request

HANGOVER PLUG

PRODUCT	DIMENSIONS		CCT			LUMEN MAX.	WATT	CRI	BEAM ANGLE			IP
HANGOVER PLUG	Ø 30	L 150	2700	3000	4000	463	7	90	22°	33°	66°	IP20
HANGOVER PLUG MICRO DOT	Ø 30	L 150	2700	3000	4000	356	7	90		32°	58°	IP20
HANGOVER PLUG	Ø 30	L 300	2700	3000	4000	451	7	90		33°	66°	IP20
HANGOVER PLUG MICRO DOT	Ø 30	L 300	2700	3000	4000	356	7	90		32°	58°	IP20
HANGOVER PLUG	Ø 30	L 450	2700	3000	4000	463	7	90	22°	33°	66°	IP20
HANGOVER PLUG MICRO DOT	Ø 30	L 450	2700	3000	4000	356	7	90		32°	58°	IP20
HANGOVER PLUG	Ø 40	L 150	2700	3000	4000	868	10	90		44°	55°	IP20
HANGOVER PLUG MICRO DOT	Ø 40	L 150	2700	3000	4000	356	7	90		32°	58°	IP20
HANGOVER PLUG	Ø 40	L 300	2700	3000	4000	868	10	90		44°	55°	IP20
HANGOVER PLUG MICRO DOT	Ø 40	L 300	2700	3000	4000	356	7	90		32°	58°	IP20
HANGOVER PLUG	Ø 40	L 450	2700	3000	4000	868	10	90		44°	55°	IP20
HANGOVER PLUG MICRO DOT	Ø 40	L 450	2700	3000	4000	356	7	90		22°	44°	IP20
HANGOVER PLUG DIRECT	Ø 75	L 150	2700	3000	4000	951	10	90	22°	44°	55°	IP20
HANGOVER PLUG DIR./ INDIR.	Ø 75	L 150	2700	3000	4000	1833	20	90	22°	44°	55°	IP20

PRODUCT
HYPRO PLUG ADAPTER

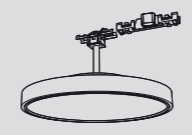
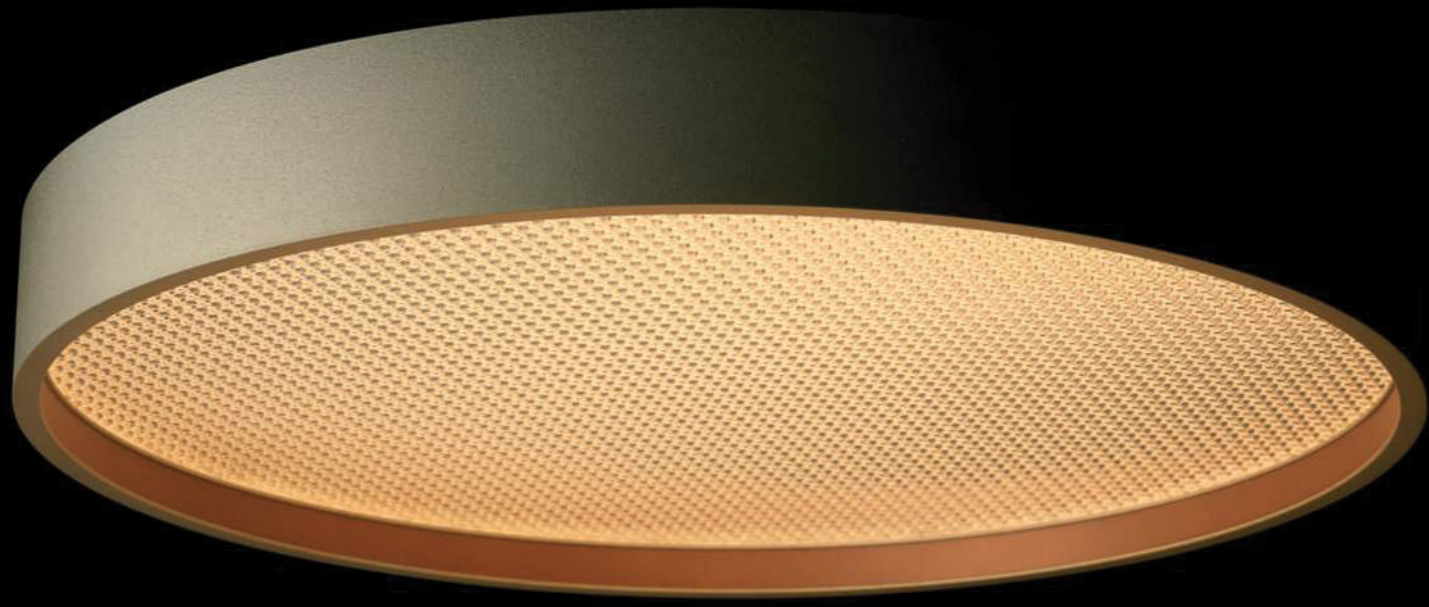

SIGN DIVA TUBE 40
Ø 400 mm

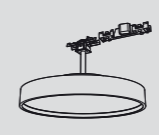

SIGN DIVA TUBE 40 | KORONA
Ø 400 mm

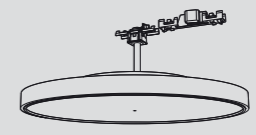

SIGN DIVA TUBE 570
Ø 570 mm

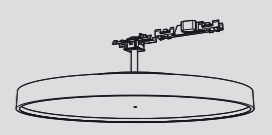

SIGN DIVA TUBE 570 | KORONA
Ø 570 mm

POWER

18 - 49 WATT

IP International Protection

IP20

SIGN DIVA TUBE SIGN DIVA TUBE KORONA



CAN-HAVE ACCESSORY: SHINE RING



COLOR TEMPERATURE CCT

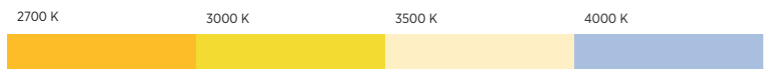

BEAMWIDTH

DIRECT



DIFUSSER

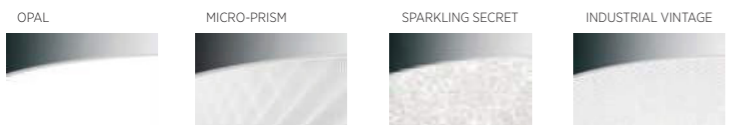

COLOR

25 PROLICHT COLORS



RAL Classic or any other color on request

SIGN DIVA

PRODUCT	VERSION	DIMENSIONS	CCT			LUMEN MAX.	WATT	CRI	IP
SIGN DIVA TUBE DIRECT		Ø 400 mm	2700	3000	4000	2058	18	90	IP20
SIGN DIVA TUBE DIRECT	KORONA	Ø 400 mm	2700	3000	4000	2058	18	90	IP20
SIGN DIVA TUBE DIRECT		Ø 570 mm	2700	3000	4000	5679	49	90	IP20
SIGN DIVA TUBE DIRECT	KORONA	Ø 570 mm	2700	3000	4000	5679	49	90	IP20

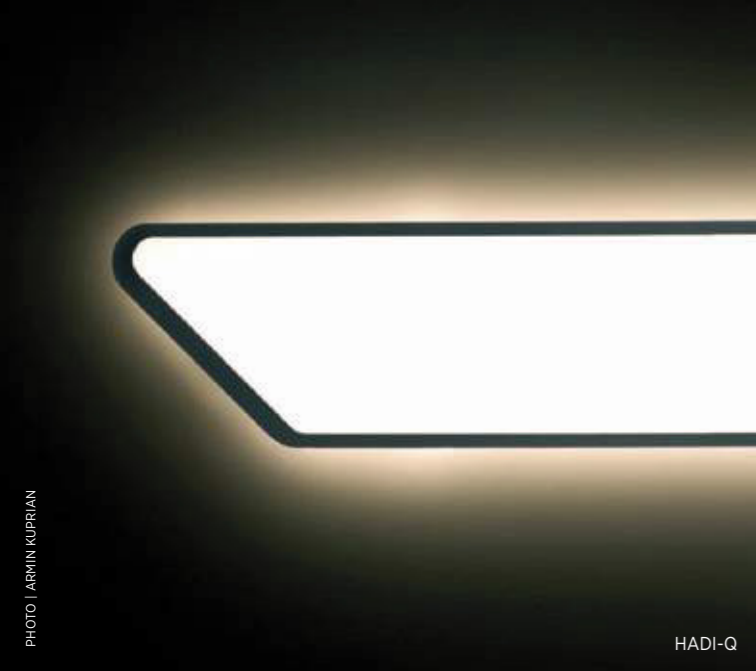

HADI-Q

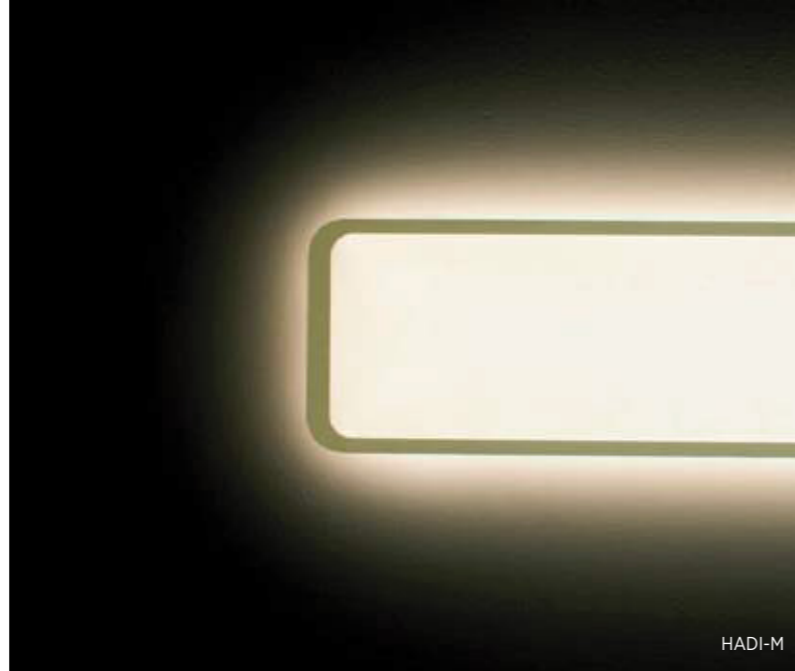

HADI-M



HADI-M SURFACE
1242 x 240 mm



HADI-Q SURFACE
1403 x 240 mm



HADI-M SUSPENDED
1242 x 240 mm



HADI-Q SUSPENDED
1403 x 240 mm

POWER

38 - 78 WATT

IP International Protection

IP20

COLOR TEMPERATURE CCT

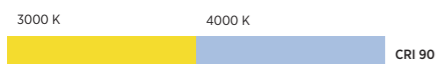

BEAMWIDTH



COLOR



RAL Classic or any other color on request

HADI SUSPENDED

VERSION	PRODUCT	DIMENSIONS	CCT		LUMEN MAX.	WATT	CRI	IP
HADI-M	DIRECT	1242 x 240 mm	3000	4000	4352	38	90	IP20
HADI-M	DIRECT/INDIRECT	1242 x 240 mm	3000	4000	6119	78	90	IP20
HADI-Q	DIRECT	1403 x 240 mm	3000	4000	3987	38	90	IP20
HADI-Q	DIRECT/INDIRECT	1403 x 240 mm	3000	4000	5899	78	90	IP20

HADI SURFACE

VERSION	PRODUCT	DIMENSIONS	CCT		LUMEN MAX.	WATT	CRI	IP
HADI-M	DIRECT	1242 x 240 mm	3000	4000	4352	38	90	IP20
HADI-M	DIRECT/INDIRECT	1242 x 240 mm	3000	4000	6119	78	90	IP20
HADI-Q	DIRECT	1403 x 240 mm	3000	4000	3987	38	90	IP20
HADI-Q	DIRECT/INDIRECT	1403 x 240 mm	3000	4000	5899	78	90	IP20



POWER

14 - 54 WATT

IP International Protection

IP20

COLOR TEMPERATURE CCT

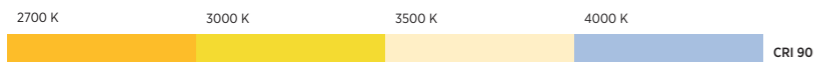

BEAMWIDTH

DIRECT



COLOR

25 PROLICHT COLORS



RAL Classic or any other color on request

MAGIQ

PRODUCT	VERSION	CCT				LUMEN MAX.	WATT	CRI	BEAM ANGLE			IP
		2700	3000	3500	4000				11°	22°	33°	
MAGIQ 4		2700	3000	3500	4000	905	14	90	11°	22°	33°	IP20
MAGIQ 4	KORONA	2700	3000	3500	4000	905	14	90	11°	22°	33°	IP20
MAGIQ 4	MICRO-DOT	2700	3000	3500	4000	742	14	90		21°	38°	IP20
MAGIQ 4+4		2700	3000	3500	4000	1809	27	90	11°	22°	33°	IP20
MAGIQ 4+4	KORONA	2700	3000	3500	4000	1809	27	90	11°	22°	33°	IP20
MAGIQ 4+4	MICRO-DOT	2700	3000	3500	4000	1483	27	90		21°	38°	IP20
MAGIQ 8		2700	3000	3500	4000	1809	27	90	11°	22°	33°	IP20
MAGIQ 8	KORONA	2700	3000	3500	4000	1809	27	90	11°	22°	33°	IP20
MAGIQ 8	MICRO-DOT	2700	3000	3500	4000	1483	27	90		21°	38°	IP20
MAGIQ 8+8		2700	3000	3500	4000	3619	54	90	11°	22°	33°	IP20
MAGIQ 8+8	KORONA	2700	3000	3500	4000	3619	54	90	11°	22°	33°	IP20
MAGIQ 8+8	MICRO-DOT	2700	3000	3500	4000	2967	54	90		21°	38°	IP20
MAGIQ	HOLLOW WALLWASH	2700	3000	3500	4000	1544	24	90	WALLWASH			IP20
MAGIQ	HOLLOW WALLWASH	2700	3000	3500	4000	1544	24	90	WALLWASH			IP20
MAGIQ	HOLLOW WALLWASH	2700	3000	3500	4000	2574	32	90	WALLWASH			IP20



HYPRO-X LINE



HYPRO-X RICO

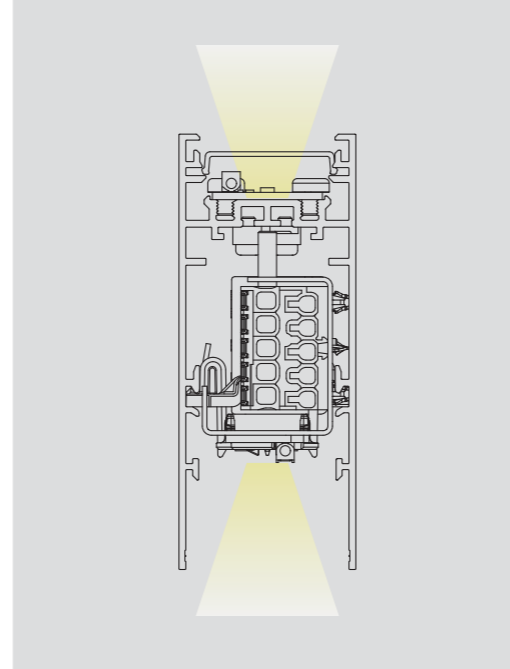

HYPRO-X INDIRECT

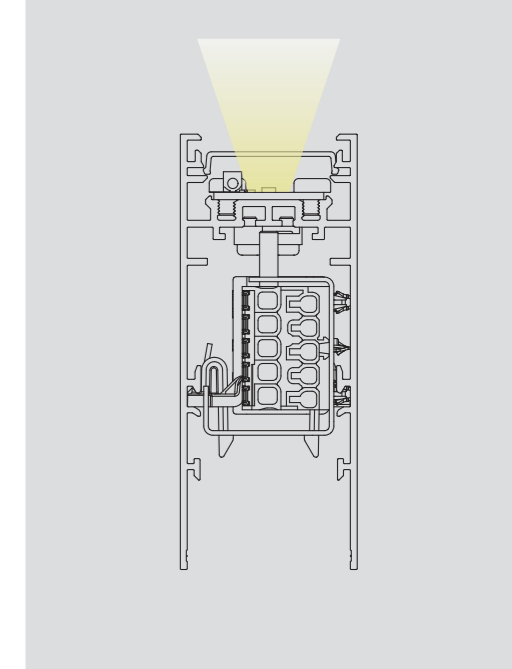

POWER

54 - 136 WATT

IP International Protection

IP20

COLOR TEMPERATURE CCT

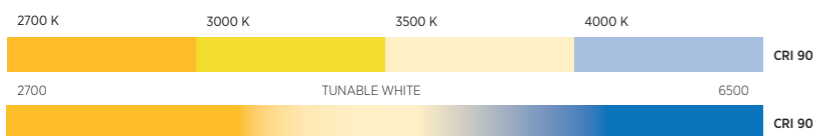

BEAMWIDTH

DIRECT / INDIRECT



INDIRECT

BEAM NARROW



BEAM WIDE



HYPRO-X LINE

PRODUCT	DIMENSIONS	CCT				LUMEN MAX.	WATT	CRI	IP
		2700	3000	3500	4000				
HYPRO-X LINE	L 1410 mm	2700	3000	3500	4000	5171	54	90	IP20
HYPRO-X LINE	L 1410 mm	TUNABLE WHITE 2700 - 6500				6925	77	90	IP20
HYPRO-X LINE	L 1835 mm	2700	3000	3500	4000	6730	66	90	IP20
HYPRO-X LINE	L 1835 mm	TUNABLE WHITE 2700 - 6500				9012	97	90	IP20
HYPRO-X LINE	L 2258 mm	2700	3000	3500	4000	8281	84	90	IP20
HYPRO-X LINE	L 2258 mm	TUNABLE WHITE 2700 - 6500				11090	120	90	IP20
HYPRO-X LINE	L 2538 mm	2700	3000	3500	4000	9308	95	90	IP20
HYPRO-X LINE	L 2538 mm	TUNABLE WHITE 2700 - 6500				12465	136	90	IP20

HYPRO-X RICO

PRODUCT	DIMENSIONS	CCT				LUMEN MAX.	WATT	CRI	IP
		2700	3000	3500	4000				
HYPRO-X RICO	L 1410 mm	2700	3000	3500	4000	5650	54	90	IP20
HYPRO-X RICO	L 1410 mm	TUNABLE WHITE 2700 - 6500				7585	77	90	IP20
HYPRO-X RICO	L 1835 mm	2700	3000	3500	4000	7353	66	90	IP20
HYPRO-X RICO	L 1835 mm	TUNABLE WHITE 2700 - 6500				9871	97	90	IP20
HYPRO-X RICO	L 2258 mm	2700	3000	3500	4000	9048	84	90	IP20
HYPRO-X RICO	L 2258 mm	TUNABLE WHITE 2700 - 6500				12147	120	90	IP20
HYPRO-X RICO	L 2538 mm	2700	3000	3500	4000	10170	95	90	IP20
HYPRO-X RICO	L 2538 mm	TUNABLE WHITE 2700 - 6500				13653	136	90	IP20

POWER

22 - 74 WATT

IP International Protection

IP20

COLOR TEMPERATURE CCT

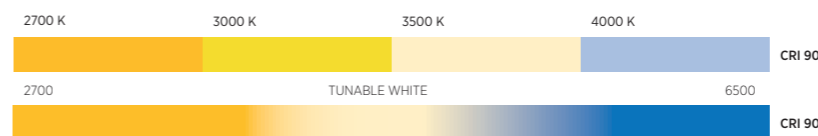

BEAMWIDTH

INDIRECT



HYPRO-X INDIRECT

PRODUCT	DIMENSIONS	CCT				LUMEN MAX.	WATT	CRI	IP
		2700	3000	3500	4000				
HYPRO-X INDIRECT	L 1410 mm	2700	3000	3500	4000	2159	22	90	IP20
HYPRO-X INDIRECT	L 1410 mm	TUNABLE WHITE 2700 - 6500				2891	41	90	IP20
HYPRO-X INDIRECT	L 1835 mm	2700	3000	3500	4000	2591	26	90	IP20
HYPRO-X INDIRECT	L 1835 mm	TUNABLE WHITE 2700 - 6500				3736	49	90	IP20
HYPRO-X INDIRECT	L 2258 mm	2700	3000	3500	4000	3454	35	90	IP20
HYPRO-X INDIRECT	L 2258 mm	TUNABLE WHITE 2700 - 6500				4630	65	90	IP20
HYPRO-X INDIRECT	L 2538 mm	2700	3000	3500	4000	3886	39	90	IP20
HYPRO-X INDIRECT	L 2538 mm	TUNABLE WHITE 2700 - 6500				5204	74	90	IP20

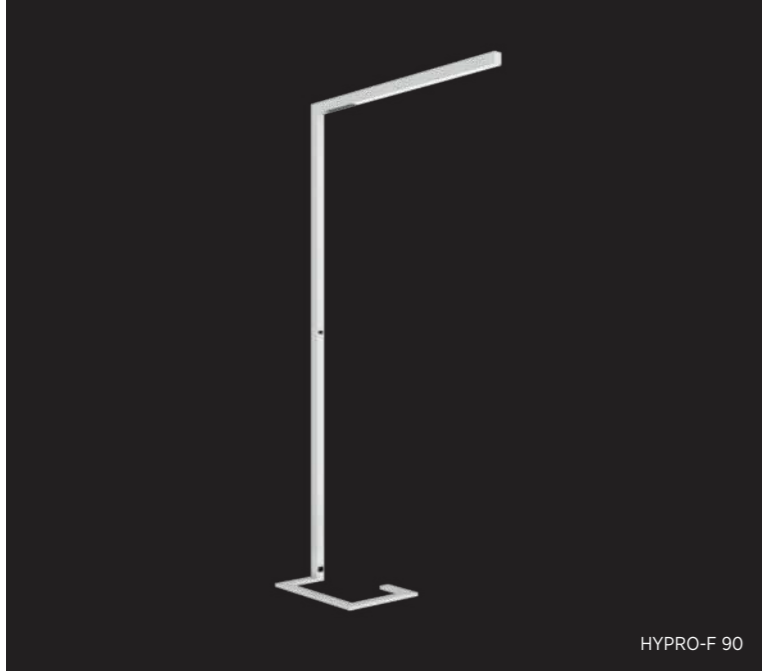

HYPRO-F 90



HYPRO-F 160



HYPRO-F 90



HYPRO-F 160

POWER

30 - 95 WATT

IP International Protection

IP20

COLOR TEMPERATURE CCT

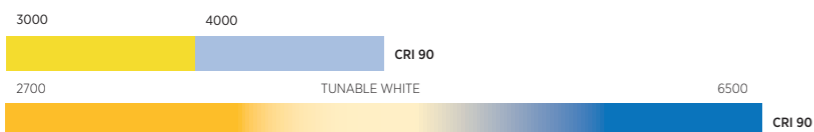

BEAMWIDTH

DIREKT



DIRECT/INDIRECT



DIFUSSER

OPAL



MICRO-PRISM



SPARKLING SECRET



INDUSTRIAL VINTAGE



COLOR

25 PROLIGHT COLORS



RAL Classic or any other color on request







HYPRO-F 90







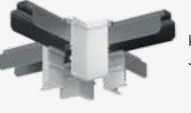



PRODUCT	VERSION	DIMENSIONS	CCT		LUMEN MAX.	WATT	CRI	IP
DIRECT		H: 2200 B: 1170 mm	3000	4000	2583	30	90	IP20
DIRECT/INDIRECT		H: 2200 B: 1170 mm	3000	4000	5458	90	90	IP20
DIRECT	TUNABLE FOCUS	H: 2200 B: 1310 mm	3000	4000	4613	65	90	IP20
DIRECT/INDIRECT	TUNABLE FOCUS	H: 2200 B: 1310 mm	3000	4000	7488	95	90	IP20
DIRECT/INDIRECT TW	TUNABLE FOCUS	H: 2200 B: 1310 mm	3000	4000	7488	95	90	IP20
DIRECT TW /INDIRECT TW		H: 2200 B: 1310 mm	TUNABLE WHITE 2700 - 6500		7488	95	90	IP20

HYPRO-F 160

PRODUCT	VERSION	DIMENSIONS	CCT		LUMEN MAX.	WATT	CRI	IP
DIRECT		H: 2200 B: 440 mm + 1170	3000	4000	2583	30	90	IP20
DIRECT/INDIRECT		H: 2200 B: 440 mm + 1170	3000	4000	5458	90	90	IP20
DIRECT	TUNABLE FOCUS	H: 2200 B: 440 mm + 1310	3000	4000	4613	65	90	IP20
DIRECT/INDIRECT	TUNABLE FOCUS	H: 2200 B: 440 mm + 1310	3000	4000	7488	95	90	IP20
DIRECT/INDIRECT TW	TUNABLE FOCUS	H: 2200 B: 440 mm + 1310	3000	4000	7488	95	90	IP20
DIRECT TW /INDIRECT TW		H: 2200 B: 440 mm + 1310	TUNABLE WHITE 2700 - 6500		7488	95	90	IP20

HYPRO FAMILY | COMPONENTS

ARTICLE	DESCRIPTION	COLOR
	SEILABHÄNGUNG MIT MONTAGECLIP SUSPENSION CABLE WITH INSTALLATION CLIP 30 x 30 mm L: 2000 mm	1-29
	SEILABHÄNGUNG MIT MONTAGECLIP SUSPENSION CABLE WITH INSTALLATION CLIP W: 38 H: 95 per meter	1-29
	EINSPEISUNG TRANSPARENT POWER FEED TRANSPARENT Ø 81 H: 2000 mm Ø 81 H: 6000 mm	1-29
	FARBEINSPEISUNG STOFF- UMMANTELUNG POWER FEED COLORED FABRIC SHEATHING Ø 81 H: 2000 mm Ø 81 H: 6000 mm	1-29
	LINIENVERBINDER LINEAR COUPLER	1-29
	KNOTEN L - VERBINDER JUNCTION L-CONNECTOR	BLACK
	KNOTEN X - VERBINDER JUNCTION X - CONNECTOR	BLACK
	KNOTEN T - VERBINDER	BLACK
	KNOTEN DECKE/WAND VERBINDER JUNCTION WALL/CEILING CONNECTOR	BLACK
	MONTAGECLIPS EINBAU INSTALLATION CLIPS RECESSED	

DESCRIPTION	COLOR
 MONTAGECLIP INSTALLATION CLIP	
 MITTENEINSPEISUNG CENTRAL FEED	
 KABELHALTER CABLE - HOLDER	
	W: 35 H: 28 mm per meter
 DIFFUSOR OPAL	705 x 35 H: 28 mm
 DIFFUSER OPAL	1128 x 35 H: 28 mm
	1408 x 35 H: 28 mm
	2113 x 35 H: 28 mm
	2815 x 35 H: 28 mm
	W: 35 H: 28 mm per meter
 MICRO - PRISMA	705 x 35 H: 28 mm
 MICROPRISM	1128 x 35 H: 28 mm
	1408 x 35 H: 28 mm
	2113 x 35 H: 28 mm
	2815 x 35 H: 28 mm
	H: 50 mm per meter
 RICO ABDECKUNG TRANSPARENT/ SCHWARZ	705 x 29 mm H: 50 mm
 RICO COVER TRANSPARENT/BLACK	1128 x 29 mm H: 50 mm
	1408 x 29 mm H: 50 mm
	1833 x 29 mm H: 50 mm
	2113 x 29 mm H: 50 mm
	2256 x 29 mm H: 50 mm
	2536 x 29 mm H: 50 mm
	2815 x 29 mm H: 50 mm
 ABDECKUNG SCHWARZ COVER BLACK	1000 x 35 H: 28 mm
	2000 x 35 H: 28 mm
	3000 x 35 H: 28 mm
 KORONA PROFIL ALUMINIUM PROFIL	1-29

ZANEEN

This product catalog has been provided by Zaneen.
Contact your local representative, zteam@zaneen.com or 1-800.388.3382