

Magiq Pro

Architectural

MAGIQ PRO

Configure your light!



EVERYTHING YOU NEED!

Unique in every aspect - maximum design freedom with endless possibilities to configure every detail individually.

MAGIQ PRO

THE DEFINITIVE LIGHTING TOOL



LIGHT AND SO MUCH MORE

Light and so much more. A family designed for light, and for light only: minimal essence, perfect beams, high power. Yet, MAGIQ PRO offers a complete set of options with infinite possibilities of configuration, to become the ultimate light design tool.

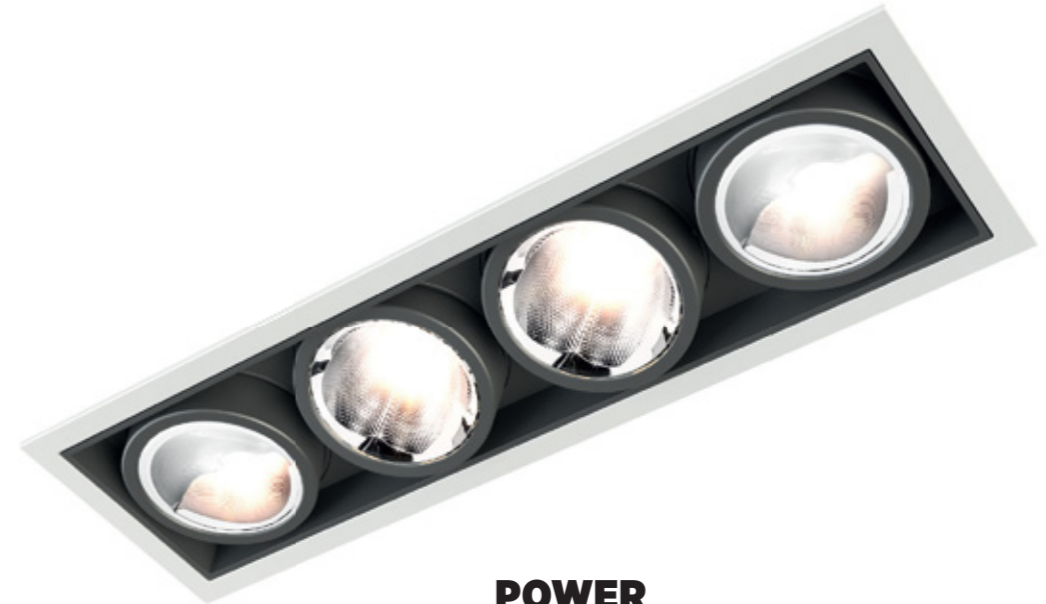

POWER

Up to four independent light sources and up to 4000 lumens from one downlight. A tool that enables you to focus on one detail and illuminate an entire room at the same time.

FREEDOM

The light beams of the MAGIQ PRO can be individually adjusted. With different beam angles, including a powerful wall washer, countless detail configurations are available, which allow a perfect tuning to fit the architecture.

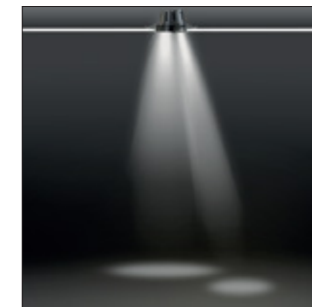

FLEXIBILITY ALL THE TIME

Greatest flexibility with MAGIQ PRO: endless combination options, fully interchangeable modules and the freedom to define the desired configuration even during installation.



THE HIDDEN SECRET FOR HIGH PERFORMANCE

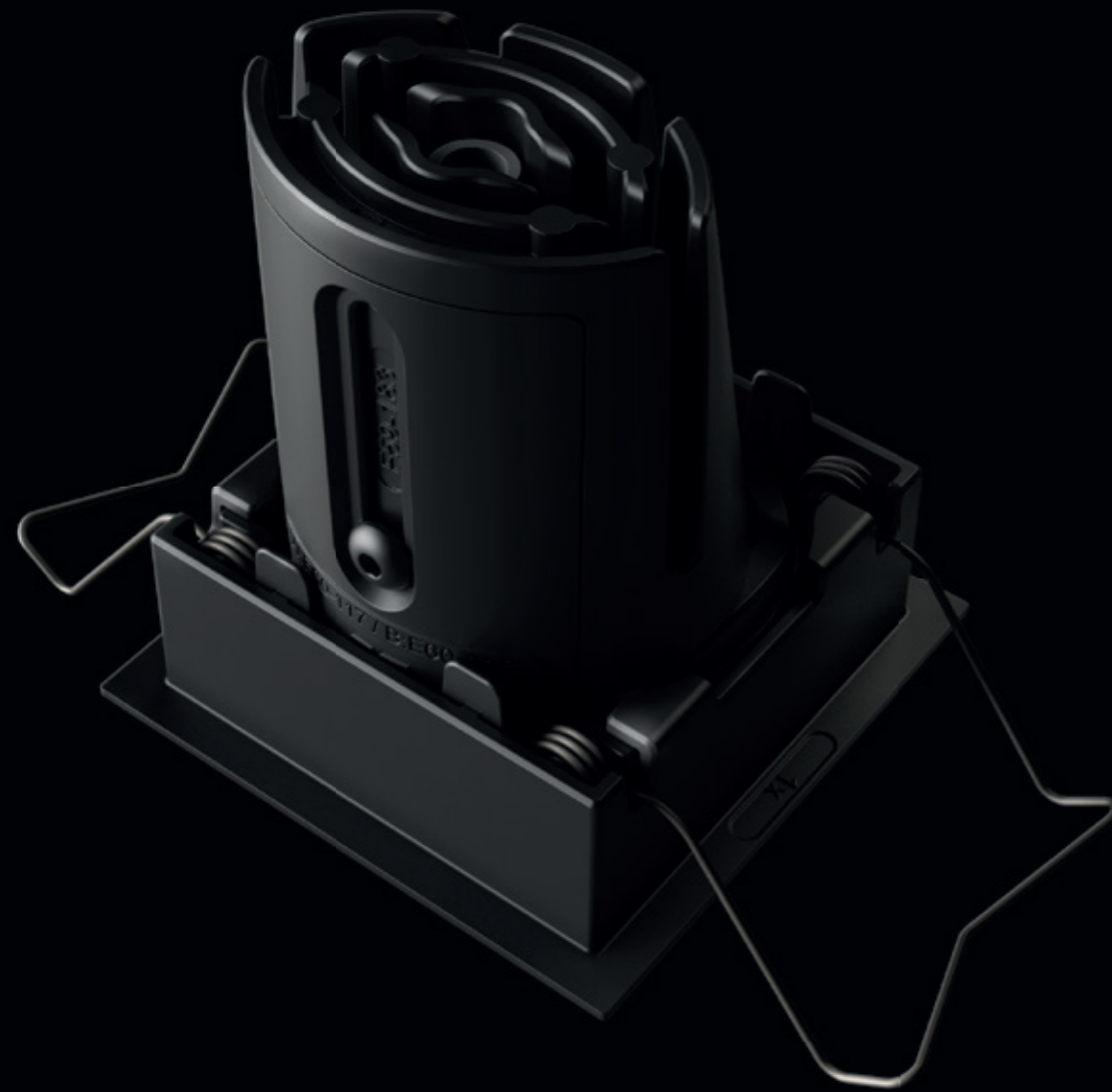

The unique heatsink design optimizes the passive thermal management generating a continuous air flow that keeps the temperature down: this is the secret to achieve great performances in such a compact dimension.

INDIVIDUALLY ADJUSTABLE

No matter whether one, two, three or four downlights, MAGIQ PRO allows the perfect fine tuning of the lighting atmosphere. This recessed spot allows complete control to tilt or rotate each light source independently.

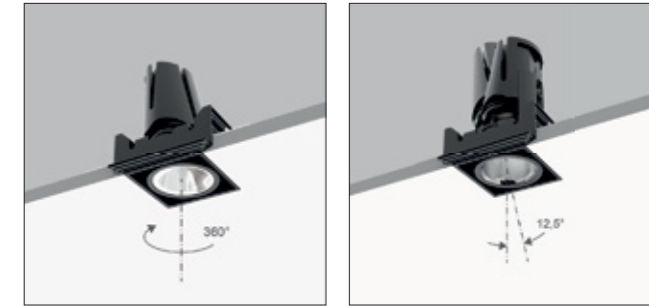

HIGH POWER, SMALL FOOTPRINT



Thanks to the great efficacy of the optic, combined with its latest generation LED module, the MAGIQ PRO guarantees a very high lumens output, despite its minimal presence in the architecture.

RECESSED mm		TRIMLESS mm		
45		55		up to 992 lm 8.5 W
60		73		up to 1984 lm 17 W
80		103		up to 2976 lm 25.5 W
80		147		up to 3968 lm 34 W

A SOLUTION FOR EVERY ENVIRONMENT

All modules are also available in a IP44 version, making the MAGIQ PRO your ideal choice for consistency also in wet areas.







TUNABLE WHITE

The optics can be equipped with 2700K, 3000K, 4000K or with an innovative Tunable White function that covers a range from 2700K to 6500K. In order to design unique light scenes, you have the complete freedom to combine modules with different light temperatures. These can be operated by using a simple control system.

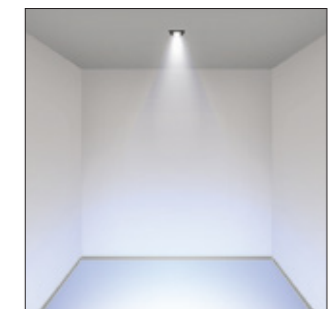
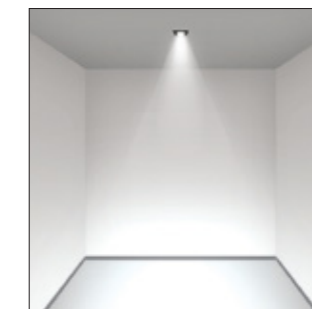
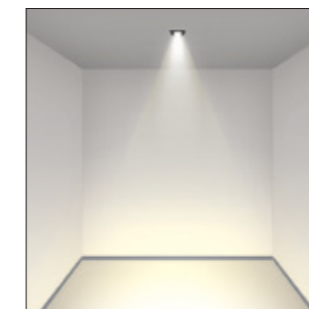
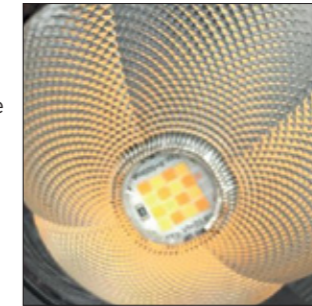

THE PERFECT BEAM

A perfect combination of reflectors and LED modules guarantees a high level of comfort with effective angles up to 60 ° without compromising efficiency and performance.

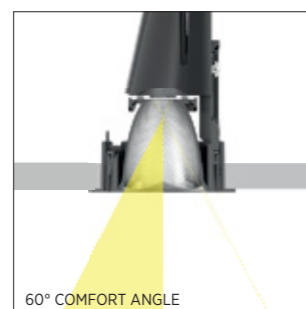

ALL LIGHT ON TARGET

The Bartenbach reflectors integrated in the MAGIQ PRO focus the light emission in a primary beam and thus offer a precise and sharp light cone without any diffusion. Additional shielding is not required.

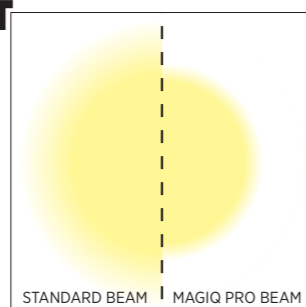

ACCESSORIES

For total control and maximum personalization of the optics, each module can be equipped with elliptical lenses, spread lenses or with a honeycomb filter.



DUAL WALLWASH FUNCTION

The unique wallwash optic of the MAGIQ PRO has a double function: it is designed for homogeneous light distribution on vertical surfaces and at the same time for an excellent downlight effect on the floor.

By using several modules on the same luminaire, high lux values for excellent lighting levels on walls and floors can be achieved.

e

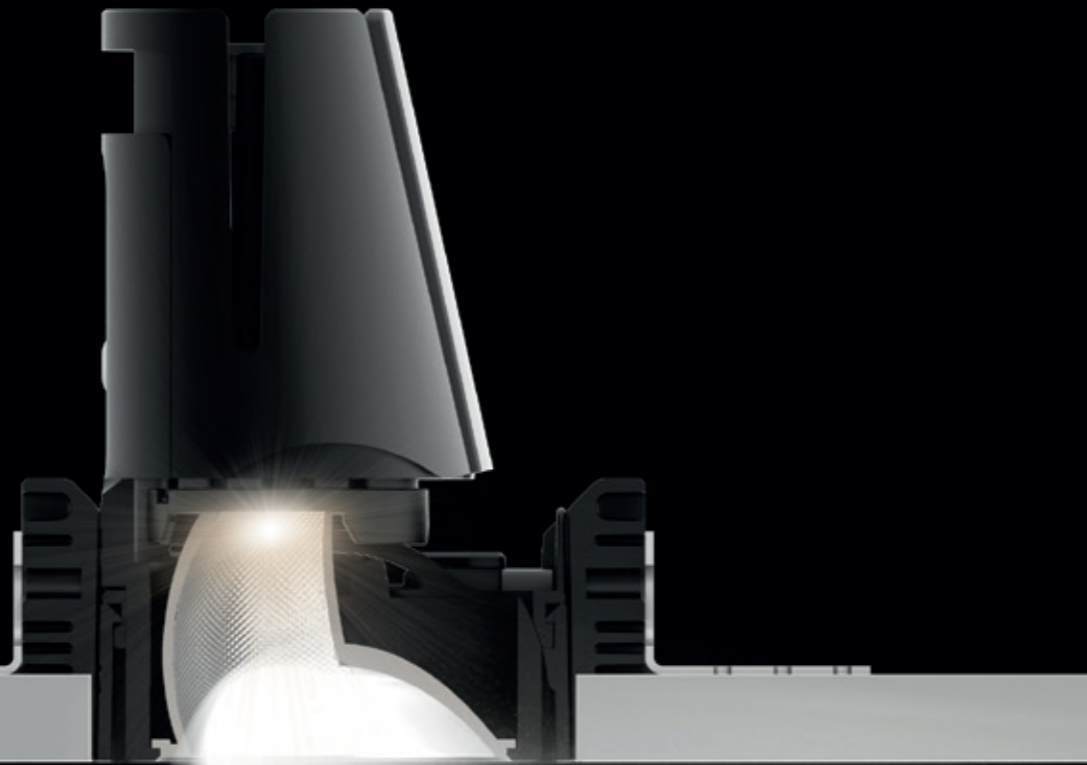

The MAGIQ PRO, equipped with several wallwash modules, is the ideal solution for ceiling walls and floors in corridors. Thanks to the independent 360° rotatability of each module, it is also possible to illuminate walls with curved surfaces.

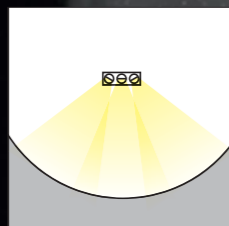
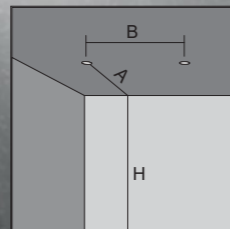
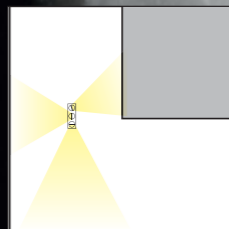

H	A	B
2.3	0.46 - 0.77m	0.70 - 1.15m
2.5	0.50 - 0.85m	0.75 - 1.25m
2.7	0.55 - 0.90m	0.80 - 1.35m
3.0	0.60 - 1.00m	0.90 - 1.50m

RECOMMENDED WALLWASH DISTANCES



PREMIUM DOWNLIGHT OPTICS

The reflector technology of Bartenbach, combined with the optic body designed by PROLICHT, becomes a holistic solution to ensure perfect lighting in diverse projects: with a portfolio spreading from Superspot to ultra wide distribution modules, the MAGIQ PRO is the perfect tool for lighting designers.



SUPERSPOT 10°

The impeccable narrow beam is ideal to stress a detail in the interior design, even from double height ceilings.



MEDIUM BEAM 30°

The solution to create contrast, to play with the light, build spaces and drama in the scene.



FLOOD BEAM 50°

Precise and multifunctional - the perfect choice for homogeneity and for multiple applications as a grid in bigger spaces.



ULTRA WIDE BEAM 70°

Incredibly wide distribution in compact dimension, yet efficient and comfortable. The ideal solution to light an entire room from one single point or to optimize the general lighting grid with a minimum amount of downlights.

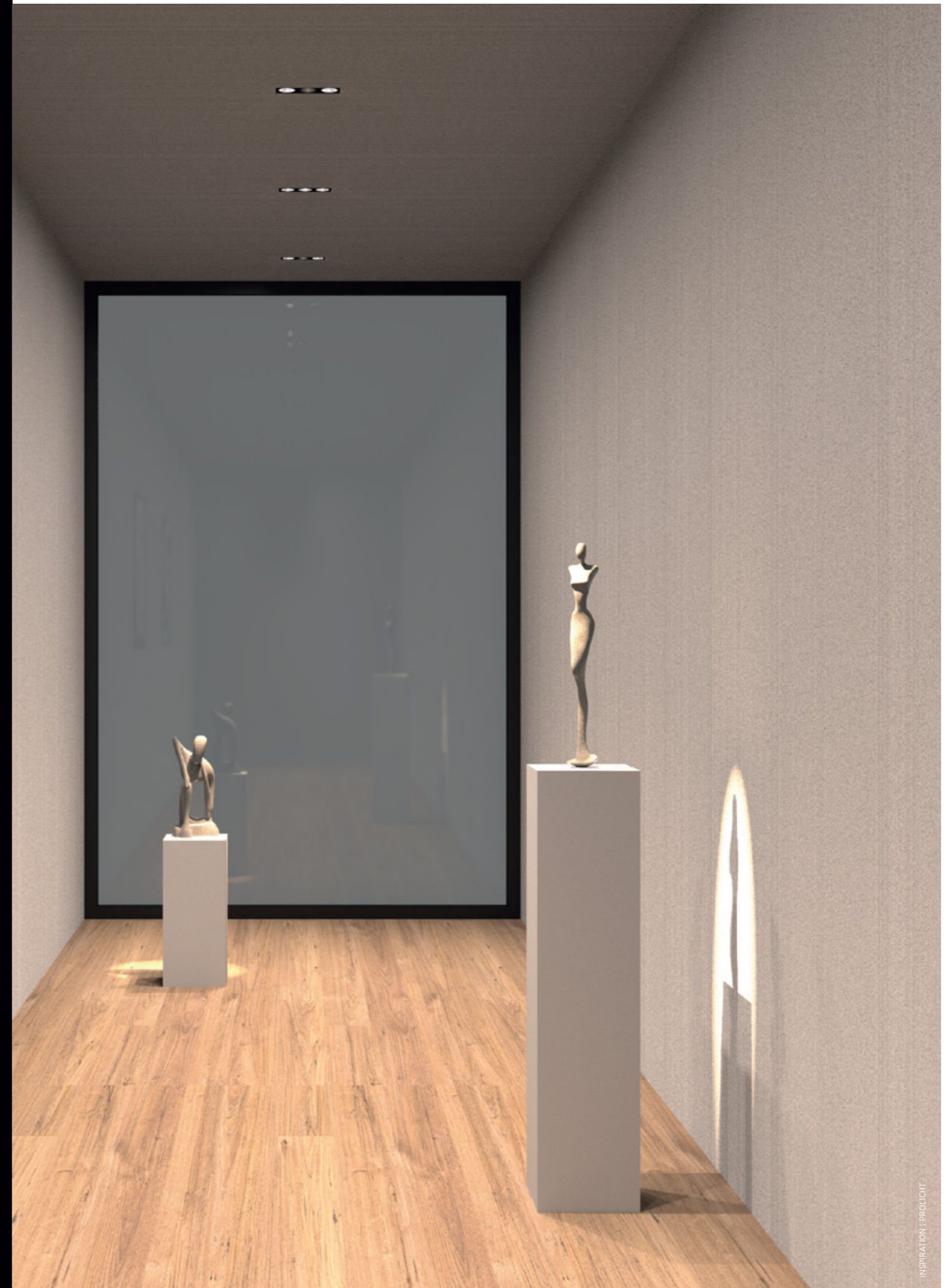

YOUR CONFIGURATION

INFINITE LIGHT APPLICATIONS

MAGIQ PRO is a solution for a space where the interior configuration is flexible and continuously changing: adjustable focus and different solutions of optics from the same fitting give the flexibility for the perfect light tuning in each new condition.

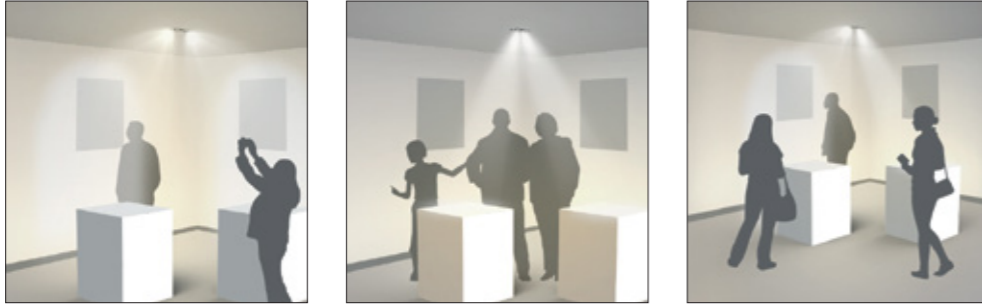

The same room can require different light set-tings at different times of the day: the individual control of each light source is key to set the perfect scene for the moment in the most simple way, transforming the environment just with light.

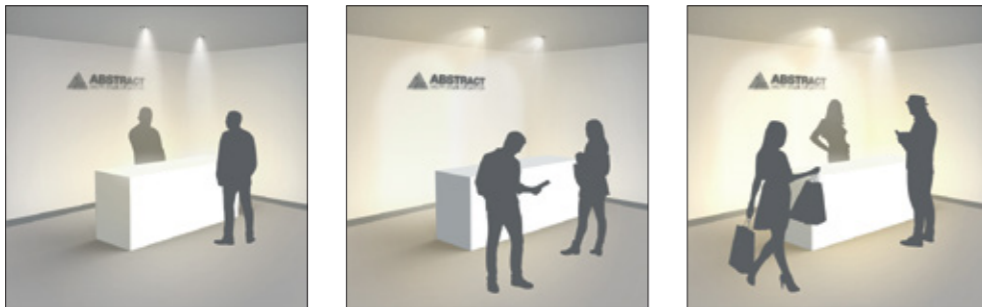

The Tunable White light source option can be combined with all optics available for MAGIQ PRO, including the wallwasher reflector, to offer consistency in the most complete way.

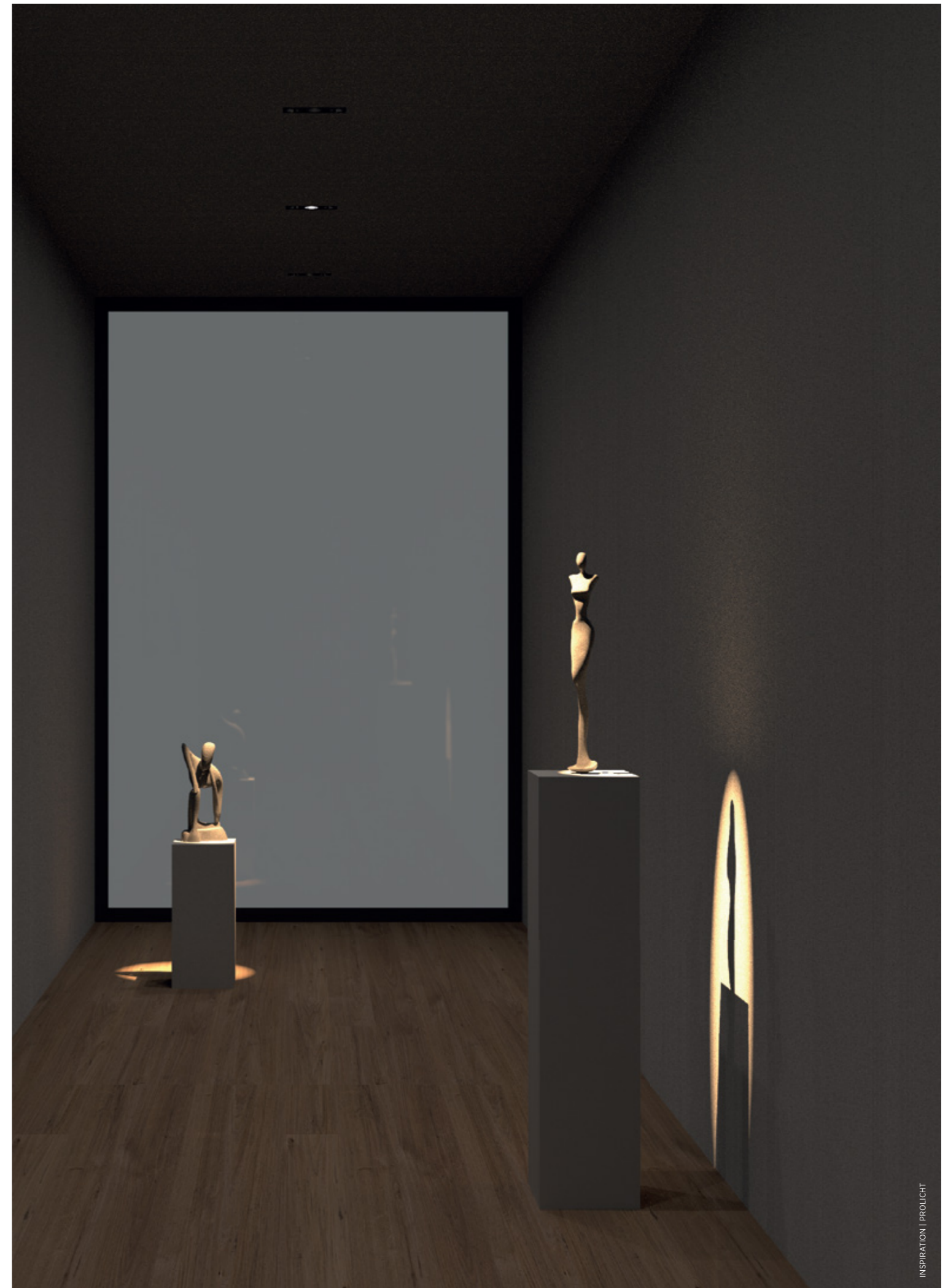
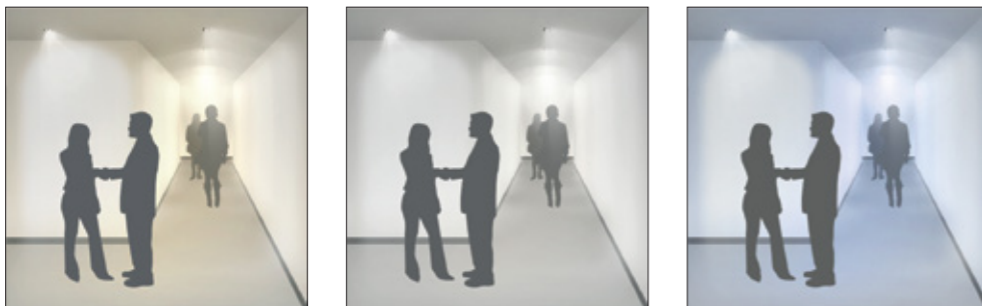



INSPIRATION | BIEFFE



MAKE IT YOURS!



PHOTOS | ARMIN KUPRIAN



PHOTO | ARMIN KUPRIAN



INSPIRATION | CIDES



COLOR

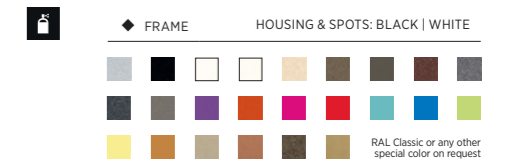

SHAPE

DIAMETER		SPOT mm	
FRAME		TRIMLESS mm	
1 SPOT 57x57	2 SPOTS 57x112	3 SPOTS 57x166	4 SPOTS 57x220
FRAME		RECESSED mm	
1 SPOT 69x69	2 SPOTS 69x123	3 SPOTS 69x177	4 SPOTS 69x231

OPTICS

COLOR TEMPERATURE	
2700 K	
3000 K	
4000 K	
TUNABLE WHITE: 2700 - 6500 K	

BEAM ANGLES	
30° 50° 70° RMJ REFLECTORS	
10° RMJ REFLECTOR	
ASYMMETRIC RMJ REFLECTOR	

CONTROL	
STANDARD ON OFF	
DALI DIM	
PUSH DIM	
0-10V	
PHASE CUT	

FEATURES

LENS PACK	
SPREAD LENS LINEAR SPREAD LENS HONEYCOMB	

ADJUSTABILITY	
SWIVELING: 12.5°	
ROTATION: 355°	

ON REQUEST

ADDITIONAL OPTIONS	
SPECIAL COLOR TEMPERATURE	
SPECIAL CONTROL OPTIONS	
SPECIAL BEAM ANGLES	
EMERGENCY LIGHTING	
SPECIAL LED	

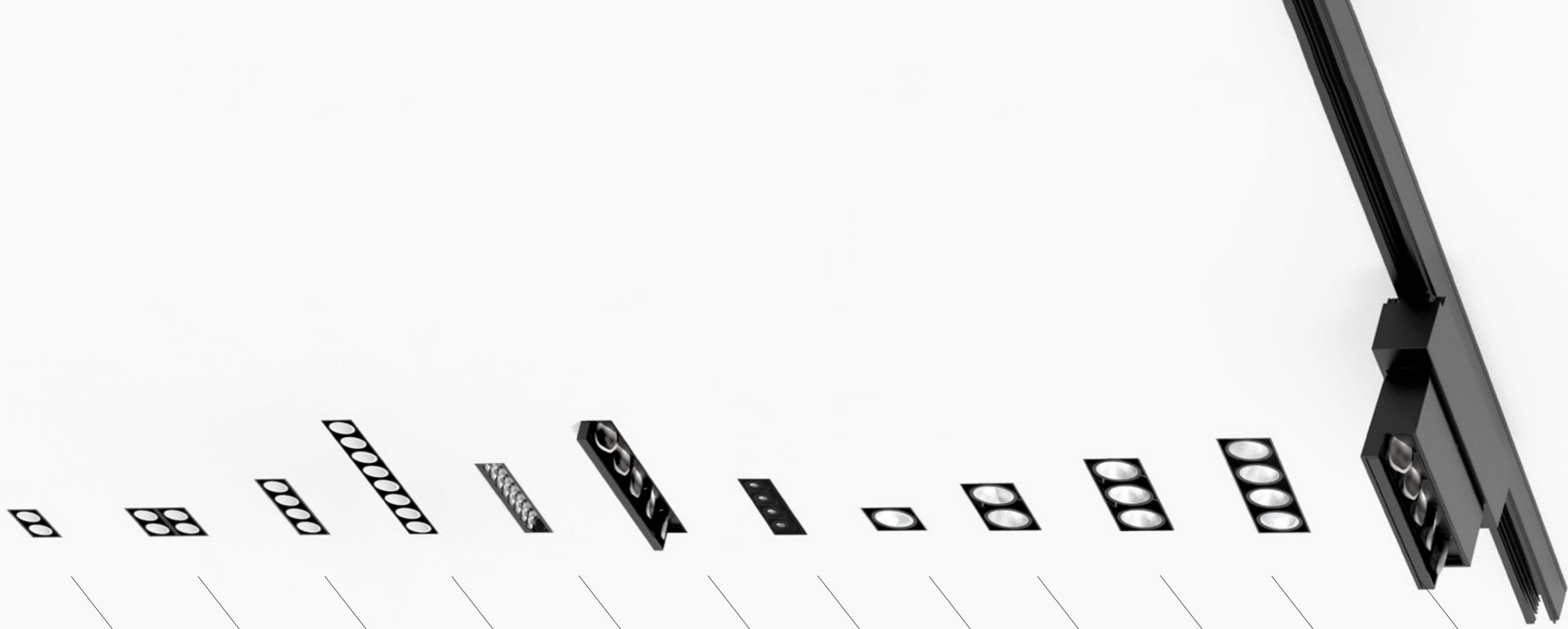

MAGIQ 2 KORONA

MAGIQ 2x2 KORONA

MAGIQ 4 KORONA

MAGIQ 8 KORONA

MAGIQ HOLLOW WALLWASH

MAGIQ WALLWASH

MAGIQ 4 LFO

MAGIQ PRO 1

MAGIQ PRO 2

MAGIQ PRO 3

MAGIQ PRO 4

MAGIQ PLUS WALLWASH

ZANEEN

This product catalog has been provided by Zaneen.
Contact your local representative, zteam@zaneen.com or 1-800.388.3382