

Acoustics

ZANEEN

Through
our values,
we promise
you
reliability.

Since 1981

“We find
strength in our
relationships
from partners
to clients.”



LABORATORY

Our in-house UL/CSA/ETL lab ensures North American safety standards, seamless customization, and impeccable quality assurance for each luminaire we deliver.

DIVISIONS

Architectural

Innovative solutions for precision lighting.

Design

Extensive range of material, form and style.

Exterior

Cutting-edge technology meets craftsmanship.

Custom

Crafting bespoke luminaires with expertise.

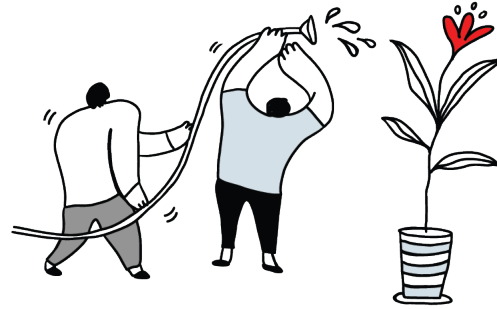

VALUES

A commitment to unwavering reliability in every aspect of our business.

Forging strong partner and client bonds.

Ensuring top-tier quality and technical advancement in our products.

Providing dependable, comprehensive client services.

PROJECTS

Zaneen serves academia, commercial, healthcare, hospitality, national accounts, and residential sectors. Collaborating with top professionals in North America, Mexico, and the Caribbean for outstanding outcomes.

PARTNERS

A collection of established European manufacturing partners exclusively available in North America through Zaneen, each with their own unique product offering.

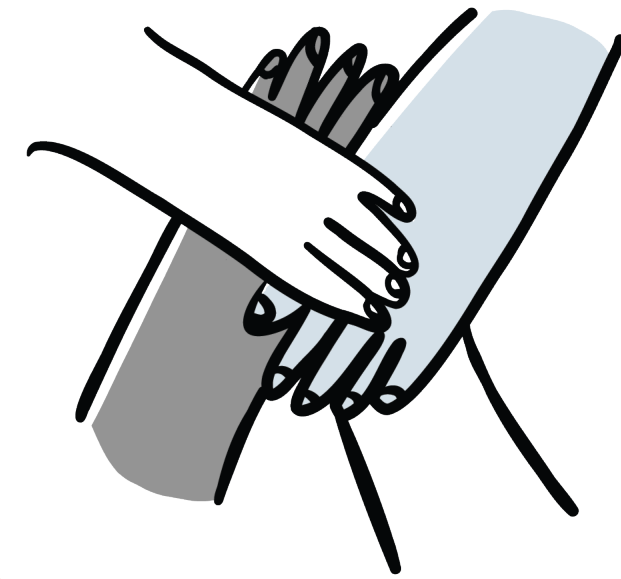



Established an in-house approved UL/CSA/ETL Laboratory, ensuring the highest quality and safety standards.



Introduced the Exterior division, providing a fresh perspective on outdoor lighting solutions.

Proudly became a second-generation family business, carrying forward a legacy of excellence and innovation.

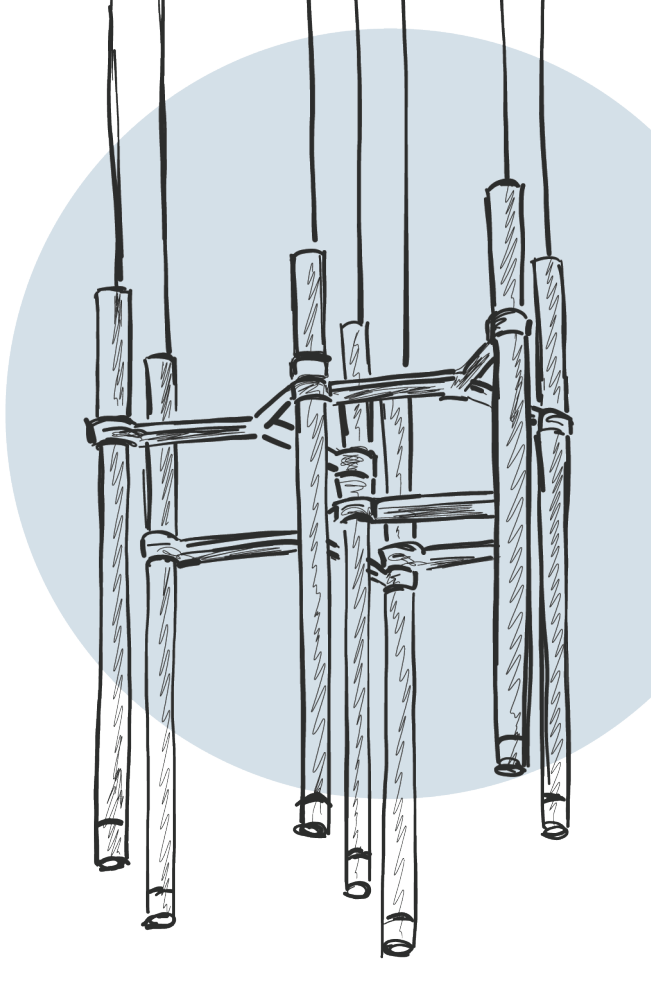

1981

1994

2007

2010

2011

2022

Robert Pietrobon and Anthony Basso co-founded Zaneen with the innovative Design division of products.

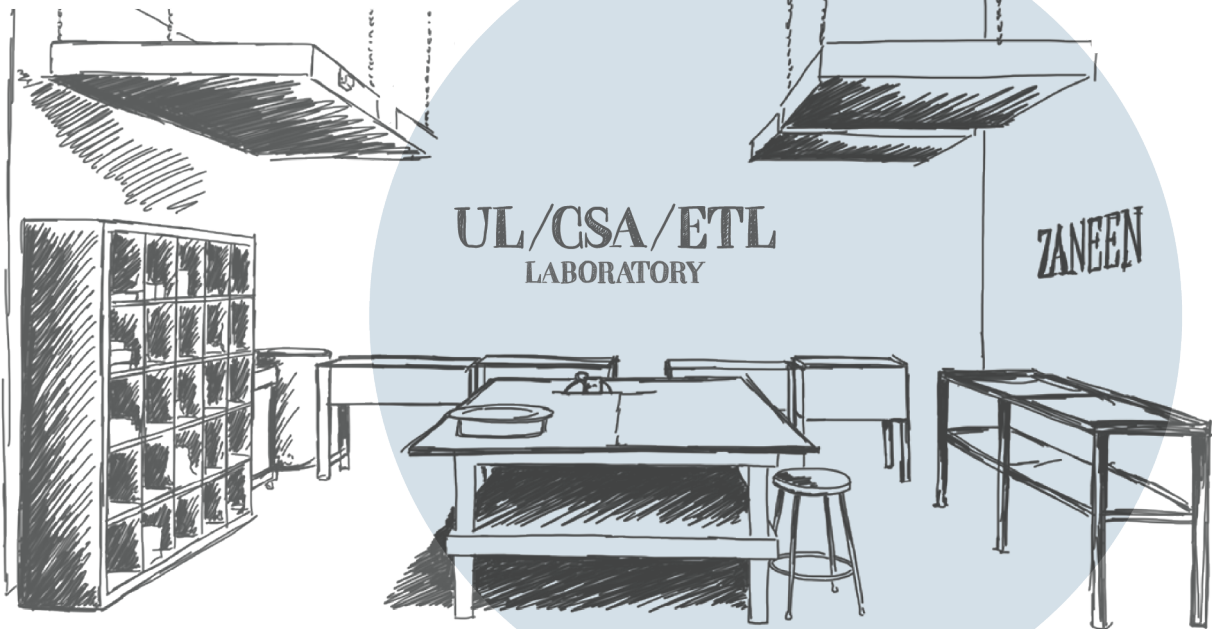

The exciting launch of the Architectural division, bringing a new dimension of product offerings.



Launched the Custom division, offering tailored lighting solutions to meet unique design needs.

Acoustic Performance	6
Diffusion vs. Absorption	7
Benefits of Noise Reduction	8
Sustainability	9
Acoustic Luminaires	10
Epiq Acoustic	11
Glorious Acoustic	12
Glorious Slim Acoustic	13
Hadi-Q Acoustic	14
Logiq Acoustic	15
Orbit Acoustic	16
Parallel Acoustic	17
Acoustic Panels	18
Get Creative with Acoustic Panels	19
Combine Solutions to Reach Noise Reduction	20
Customization	21
Explore Custom Lighting Solutions	22
Make It Your Own	23
Create Your Own Acoustic Solution	24
Play with Color	25

Acoustic Performance

Welcome to a world where excellent acoustics and lighting converge, creating an atmosphere of perfect harmony. Drawing from our expertise in lighting technology, we have seamlessly integrated innovative acoustic products to craft luminaires that exceed the highest standards in the professional lighting sector, catering to diverse spaces ranging from offices to hospitality venues.

Acoustic products emerge as a powerful solution that significantly enhances the ambiance of a room, all while maintaining an impeccable design. By skillfully harmonizing acoustic and lighting elements, you can create spaces that nurture both the body and mind, fostering a sense of tranquility and enabling individuals to thrive in their environments.

We offer ground-breaking products that set an unmatched standard in their category by blending cutting-edge technical performance with unconventional design elements. The perfect acoustic solution empowers the space to be truly dominated by what matters most – your thoughts and ideas.



Diffusion vs. Absorption



Understand how the two work together

When a sound wave encounters a surface within a room, it undergoes two possible outcomes: diffusion and absorption. A portion of the sound is reflected and returned to the room, while the rest is absorbed by the surface.

When sound waves encounter surfaces that don't absorb them, they travel in multiple directions, culminating in unwelcome noise. By strategically placing acoustic properties above noise sources, we can effectively mitigate sound diffusion, creating a more serene and conducive environment.

A higher absorption rate indicates the material's superior ability to improve the acoustics in the room, as it efficiently absorbs the sound energy, reducing reflections and creating a more pleasant and balanced auditory environment.

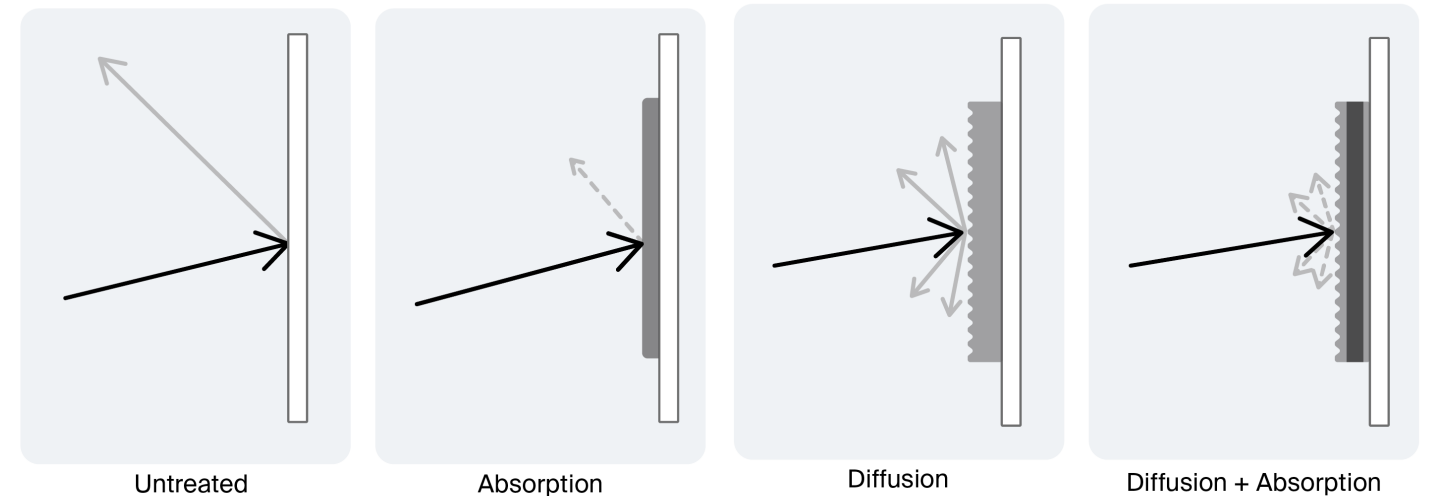

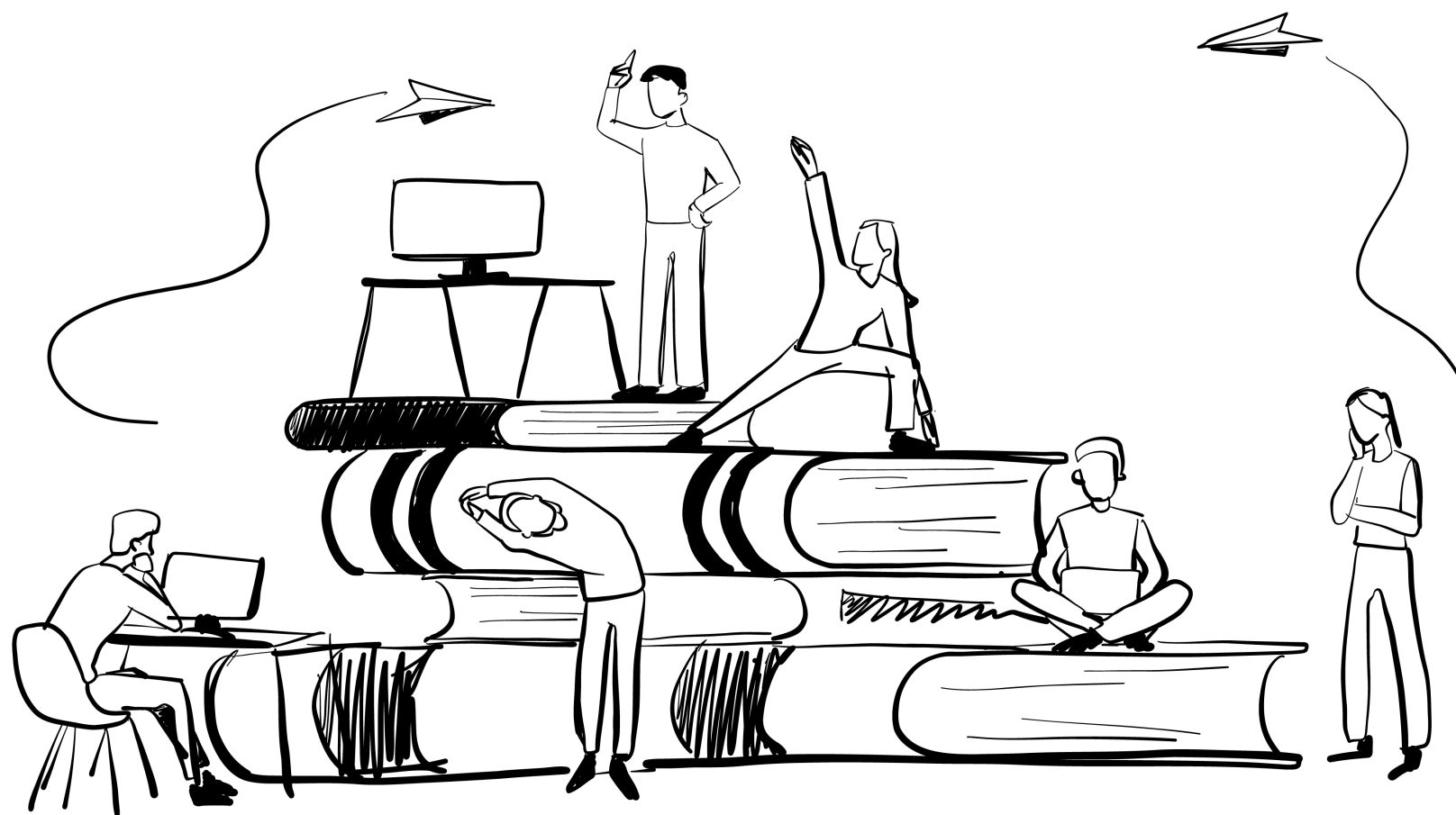

Benefits of Noise Reduction

Tap into greater potential with the right tools

Enhancing the atmosphere of a room is paramount for fostering successful work, enjoyment, and social interactions. Extensive research reveals that a tranquil environment, especially within a professional setting, has a profound effect on boosting productivity and overall well-being. In certain settings, noise can be a significant distraction, leading to reduced concentration and productivity. Reducing background noise helps individuals maintain focus, leading to higher efficiency and better task performance.

To unlock the benefits, two essential elements come into play—optimal lighting conditions and a favorable acoustic atmosphere.



Sustainability with Acoustics

Initiate positive change and leave a lasting impact

Contributing to a better planet is achievable through conscious decision-making and embracing sustainable initiatives. To bring about a much-needed change, incorporating sustainable indoor acoustic products can be a simple yet impactful step. Our acoustic panels are crafted from fibers sourced from recycled water bottles, providing both an eco-friendly and powerful solution to your acoustic needs.

Together, we can pave the way for a brighter future—one that reflects both our individual needs and our shared commitment to a greener and more environmentally conscious world.

Acoustic Luminaires

Lighting meets design, technology meets art, and functionality meets acoustics, elevating your space to unparalleled levels of excellence.

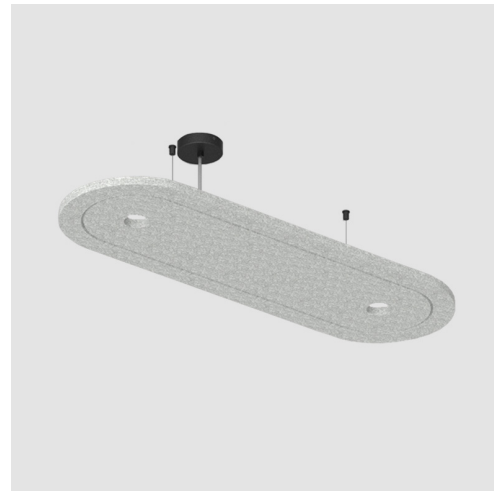

**Epiq
Acoustic**



**Orbit
Acoustic**



**Glorious
Acoustic**

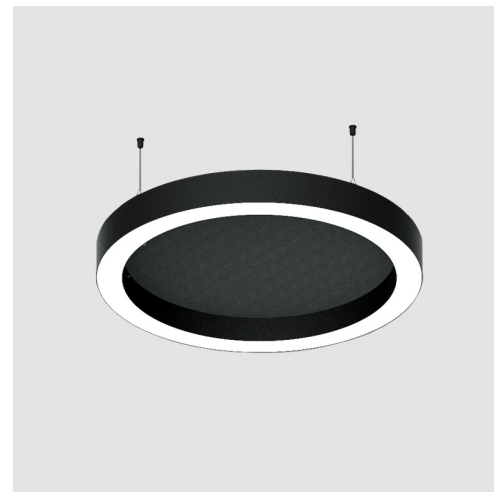

**Glorious Slim
Acoustic**

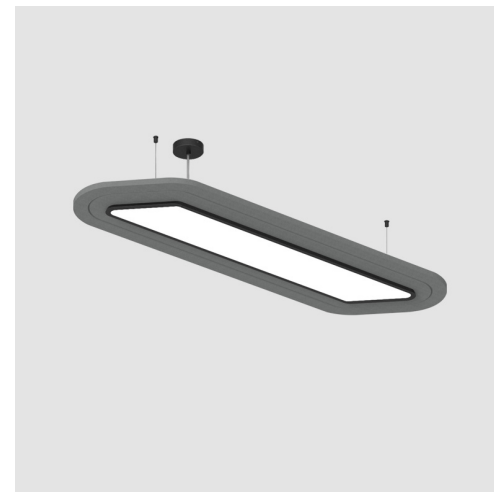

**Hadi-Q
Acoustic**

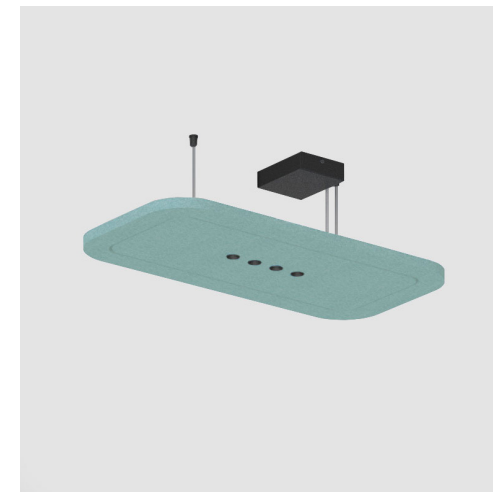

**Logiq
Acoustic**



**Parallel
Acoustic**



Epiq Acoustic

Freedom of choice

Epiq is a suspension solution offering more than meets the eye. It's an acoustic panel that grants you the freedom to incorporate any downlight, including the Oiko Pro and Invader Compact. Its distinctive shape elegantly merges form and function, complemented by sustainable acoustic materials. Epiq delivers the option of powerful illumination and remarkable flexibility paired with effective sound absorption and diffusion, crafting an ideal atmosphere tailored to your preferences.

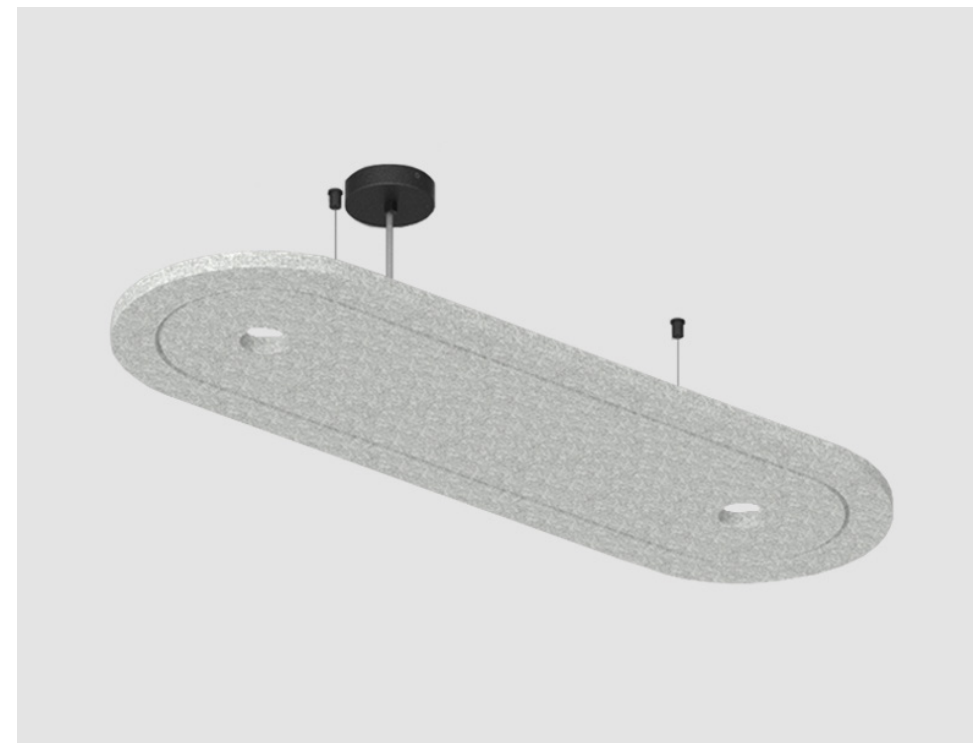

The Invader Compact downlight exemplifies minimal size with maximum output; featuring low fixture depth while maintaining high lumens.

Glorious Acoustic

Pop art meets acoustic function

Glorious Acoustic is an innovative acoustic lighting solution that elevates spaces to new heights with its captivating design. Crafted in a three-dimensional shape, Glorious Acoustic casts a remarkable and easily recognizable effect. The integrated acoustic panel establishes a perfect synergy between functionality and design, enhancing the acoustics and visual allure of a space.



Choosing an opal diffuser for even light distribution or a microprism diffuser with optimal glare control provides an additional option to tailor the luminaire to its destination.

Optional available LED boards can be installed on a recessed top-plate to allow indirect lighting.



Glorious Slim Acoustic

The best just got better

The latest evolution of a beloved lighting solution, Glorious Slim Acoustic builds upon the allure of oversized and geometric Glorious lights. This new version adds a touch of dramatic flair while incorporating acoustic panels to elevate the range. Experience the ideal blend of aesthetics and functionality as Glorious Slim Acoustic not only enhances the visual appeal but also optimizes room acoustics to meet your fundamental needs.

In combination with a white base plate, the white internal reflector creates a perfect mixing chamber. This creates a homogeneous light pattern without individually visible LED dots. The GLORIOUS pendant luminaires are configurable in one of the 25+5 PROLICHT colours and as an additional highlight can also be individually customized by engravings (eg texts or logos).



The oversized geometric Glorious Slim Acoustic is offered with Direct and Indirect lighting.





Thanks to its outstanding efficiency one single HADI can illuminate two working desks (according EN 12464), minimizing the power consumption for the desired lighting level. Its CRI > 90, combined with an URG < 19 and its perfectly homogeneous emitting surface make the HADI the ideal solution for comfortable office space.

Hadi-Q Acoustic

A comprehensive office solution

Hadi-Q doubles as a dynamic piece of art that seamlessly integrates sophisticated technology without compromising aesthetics. The diecast aluminum frame houses a highly efficient edge lighting engine, shielded by a multilayer prismatic sandwich diffuser, ensuring optimal light distribution across the workspace. Going beyond traditional lighting fixtures, Hadi-Q incorporates an acoustic panel surround, adding another layer of success to the equation.

Logiq Acoustic

Focusing the attention on important details

This innovative suspended acoustic lighting fixture blends illumination and optimal acoustics in one package. The high-tech lens utilized in Logiq ensures an almost invisible light source, allowing the fixture to have a non-intrusive approach. The perfect harmony of design and performance available with Logiq transforms your space into an oasis of productivity.



The deep reflector effectively passes the light past the cone without altering the light colour.

The integrated LFO lens, enables the lowest UGR ratings to be achieved, while ensuring a soft fade out of the light cone compared to a reflector. Perfect for residential and hospitality applications!

The Bartenbach LFO lenses provide a 34° or 58° beam angle and ensure a glare-free downlight without illuminating the luminaire's housing.

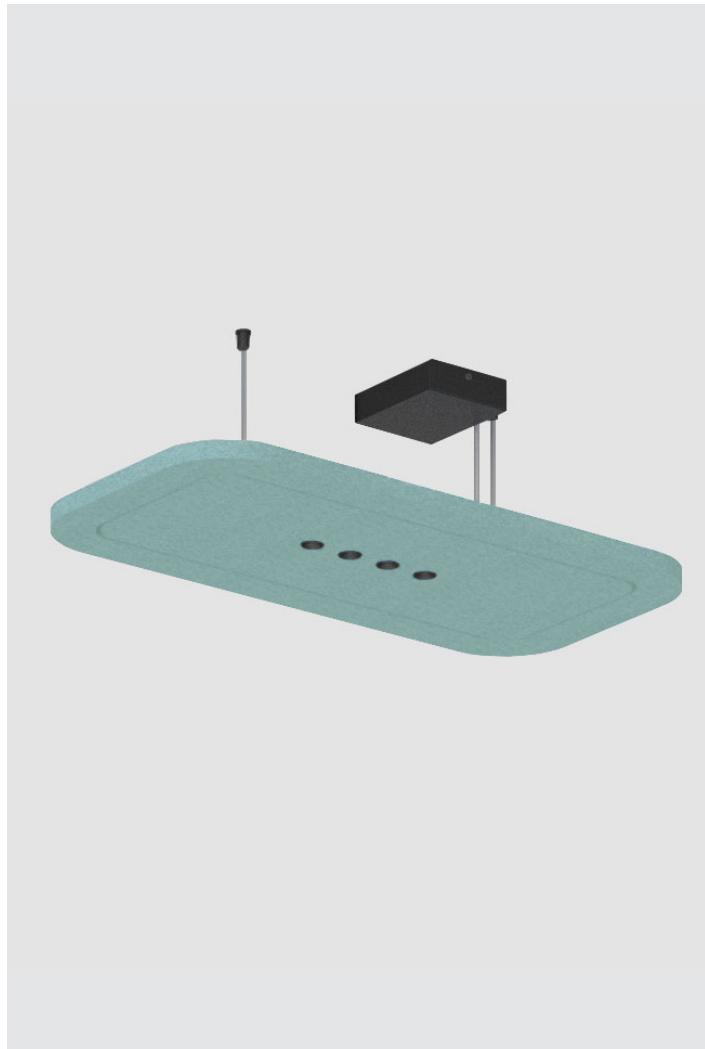

Orbit Acoustic

A circular acoustic canvas

Similar to Epiq, Orbit is a perfectly rounded acoustic panel that offers the ultimate freedom to incorporate your choice of downlights, including the Oiko Pro and Invader Compact. Seamlessly merging acoustic sophistication with dynamic lighting, Orbit empowers you to craft captivating lighting scenes while enjoying effective sound absorption and diffusion. Create an ideal ambiance for work and leisure on your terms.



The Oiko Pro downlight utilizes advanced Bartenbach reflectors for precise beam angles, ensuring complete light control and perfect distribution.



Parallel Acoustic

A concealed light source

With Parallel, precise illumination of workspaces is a breeze, thanks to its reflectors that allow for focused and directed light distribution. The recessed LED source cleverly conceals itself in the acoustic panel, creating an almost ethereal glow, while the diffuser sets below the acoustic frame to create an almost ethereal glow. Available in two thicknesses, 24mm and 12mm, and two size options, Parallel offers the flexibility to suit diverse spatial requirements.

Optimal above workplaces and at the same time a light that meets the highest demands for the professional sector.

Available in any colour temperature you can think of, the Parallel makes functional lighting a breeze in multiple project types.

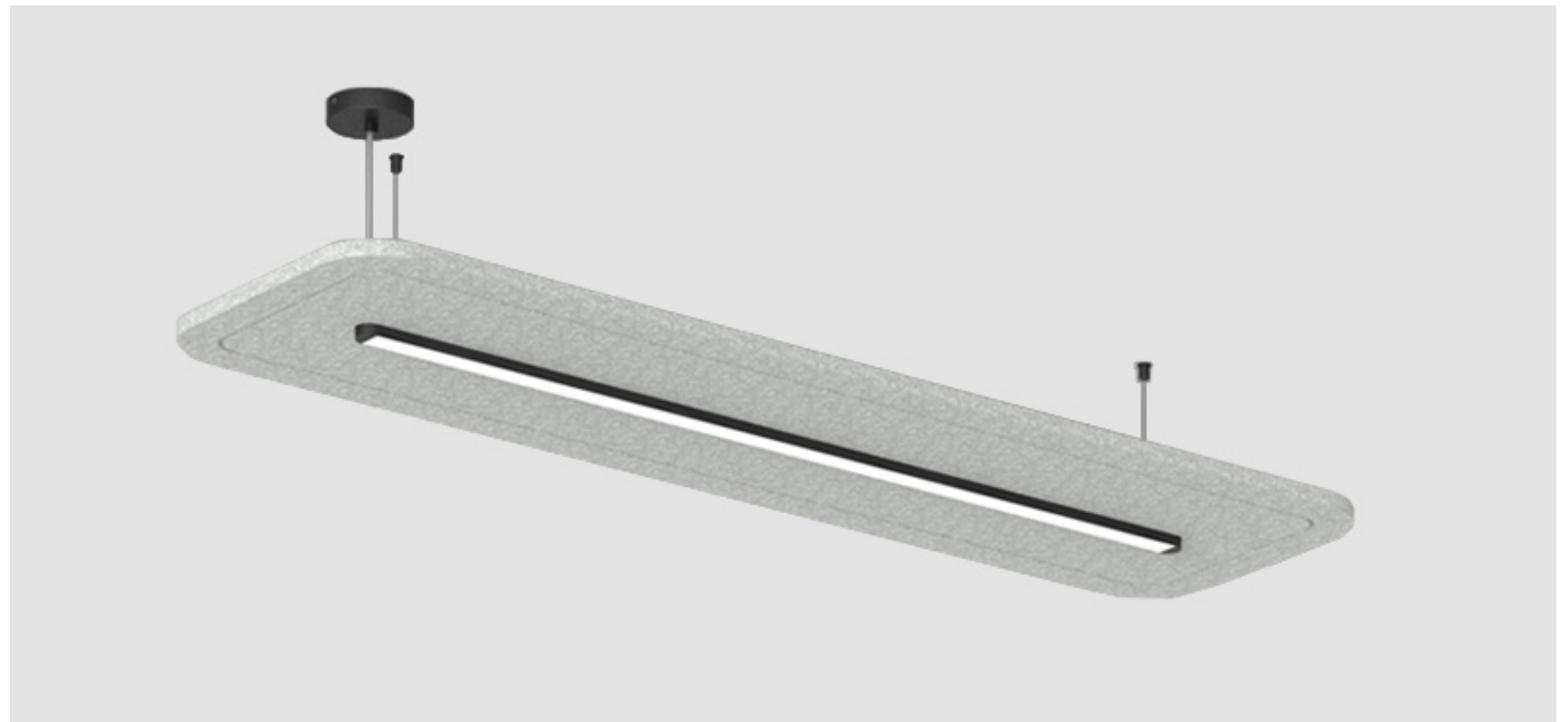



Acoustic Panels

Explore the diverse applications of acoustic panels to reveal their significant impact on creating tailored environments.



Ceiling panel



Baffle



Privacy Screen

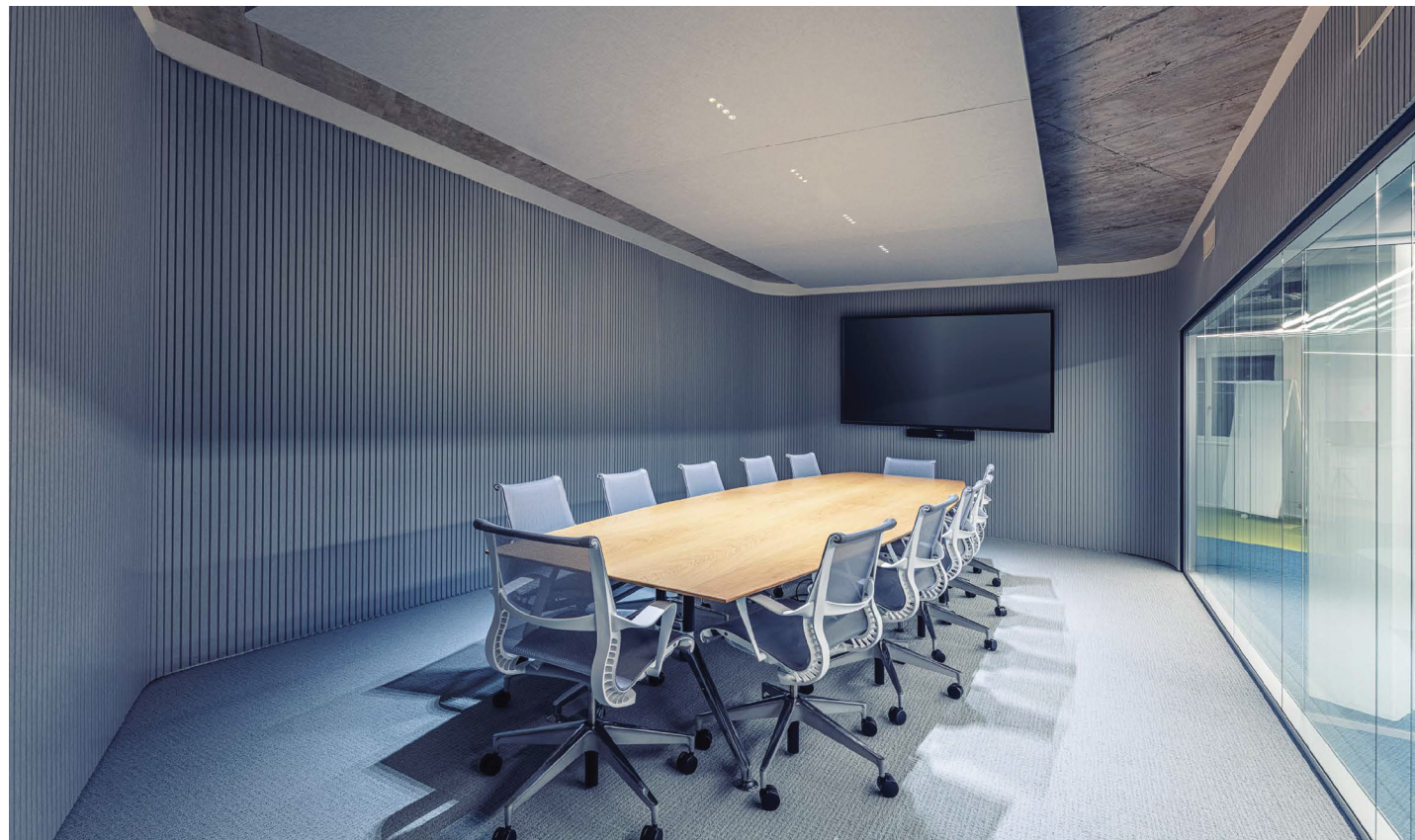

Wall panel

Get Creative With Acoustic Panels

Acoustic panels offer a range of applications beyond their initial purpose. In certain settings, such as offices, healthcare facilities, noise reduction measures help maintain privacy and confidentiality. Sensitive conversations and discussions can be better protected from eavesdropping, ensuring a more secure and trusted environment. Conversely, reducing background noise in public places, restaurants, or social gatherings can improve communication between individuals. This fosters more meaningful conversations and better social connections, contributing to an overall positive social experience.

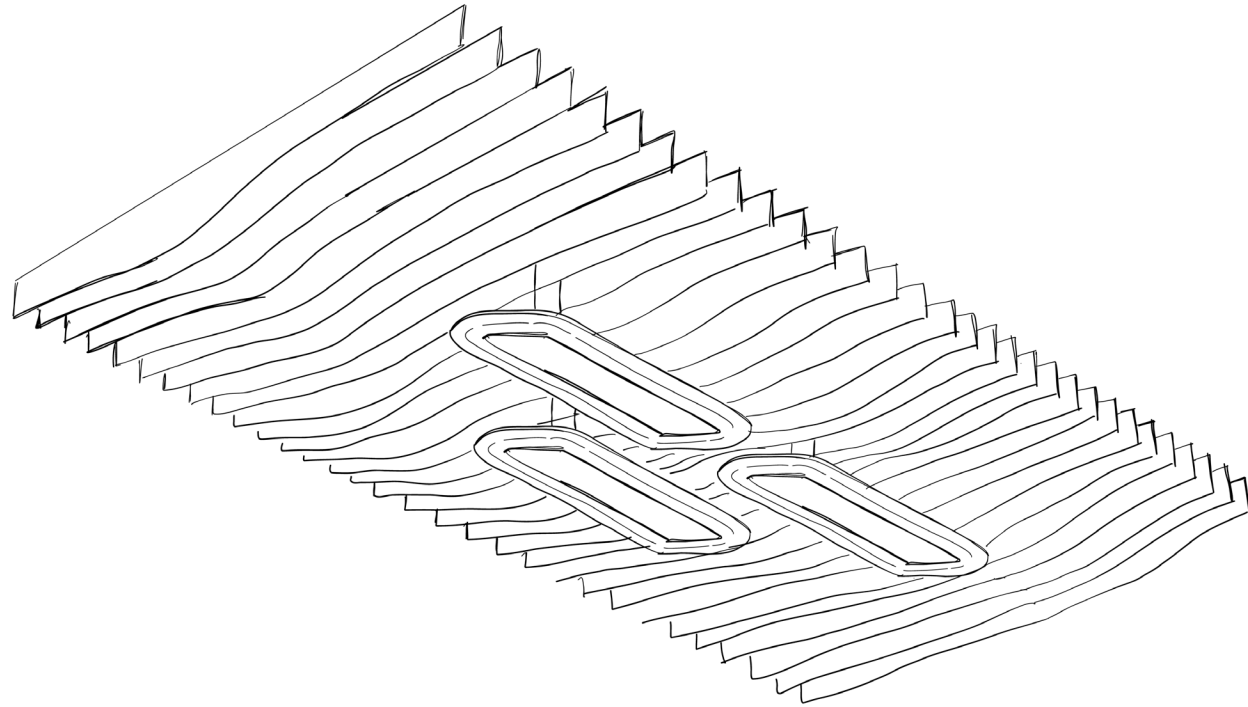

Sketch

Combine Acoustic Panels to achieve noise reduction goals

While acoustic luminaires offer noise reduction benefits, they may not be sufficient to achieve the level of acoustic comfort necessary in certain environments. To fully optimize noise reduction effects, complementing an acoustic luminaire with additional acoustic panels is essential. These panels provide an added layer of sound absorption and diffusion, effectively controlling reverberation and minimizing unwanted noise. By combining acoustic luminaires with dedicated acoustic panels, spaces can be transformed into more peaceful and acoustically balanced environments.



Combination of hadi-q acoustic and an acoustic baffle





Customization

Our commitment to customization extends to our range of acoustic luminaires, allowing us to craft solutions that precisely match the unique requirements of every project.

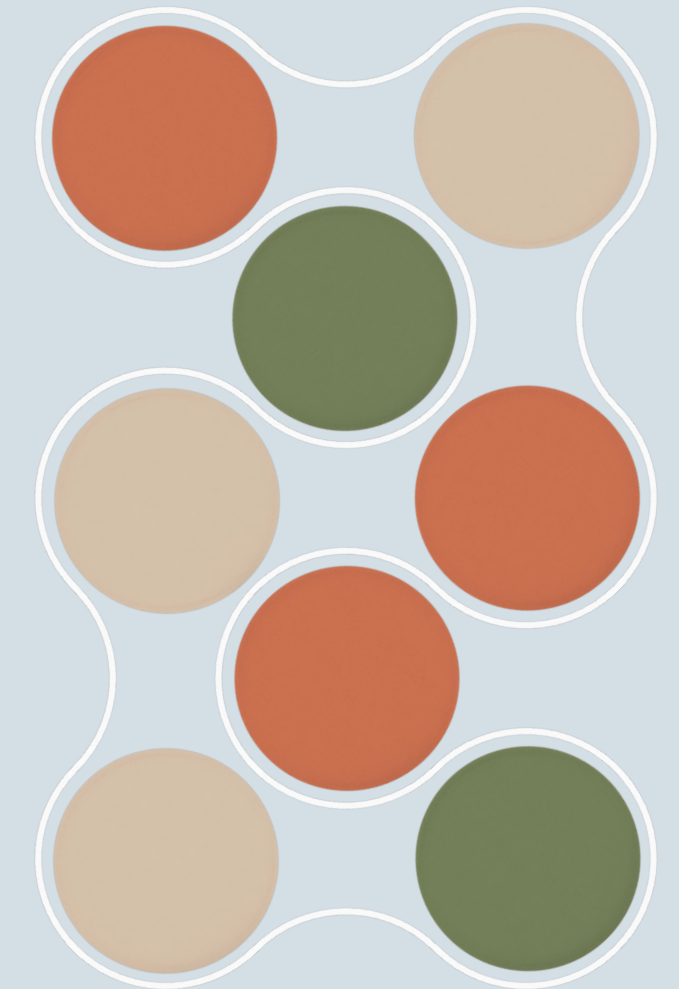

Create Your Own Acoustic Solution

An innovative and effective solution to address both lighting and noise reduction needs is the option to specify standard Zaneen lighting products with acoustic panel surrounds. For example, the widely acclaimed Super-G fixture can be enhanced by incorporating acoustic panels on either side. This integration seamlessly combines the benefits of superior lighting performance with exceptional noise reduction capabilities. Spaces can not only benefit from visually appealing lighting solutions but also enjoy the added advantage of a quieter and more peaceful atmosphere.



Make it your own

One of the key advantages is our flexibility to tailor the standard acoustic luminaires to suit the specific needs of any project. We offer the capability to adjust the size of these luminaires as well as the integrated lighting system. Whether it's an expansive open-plan office that demands ample illumination with noise reduction properties or a cozy boutique restaurant seeking a perfect blend of aesthetics and acoustic comfort, our adjustable acoustic luminaires deliver on both fronts. This adaptability empowers designers and architects to create spaces that not only provide optimal lighting solutions but also address acoustic concerns.



Explore Custom Lighting Solutions

We take pride in our ability to collaborate with clients to comprehend their distinctive needs and together, craft a bespoke acoustic solution that meets the functional needs and enhances the aesthetic appeal of an environment. By combining our expertise with your vision, we strive to deliver solutions that are a true expression of your individuality, transforming spaces into inspiring settings.

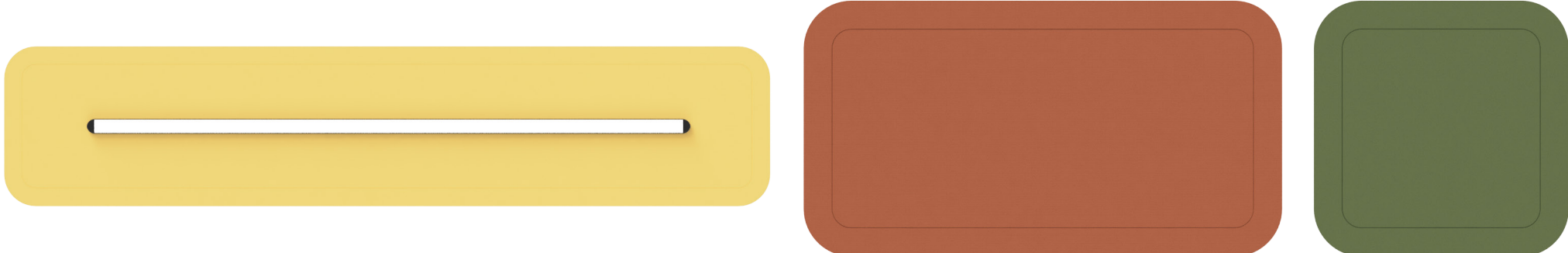

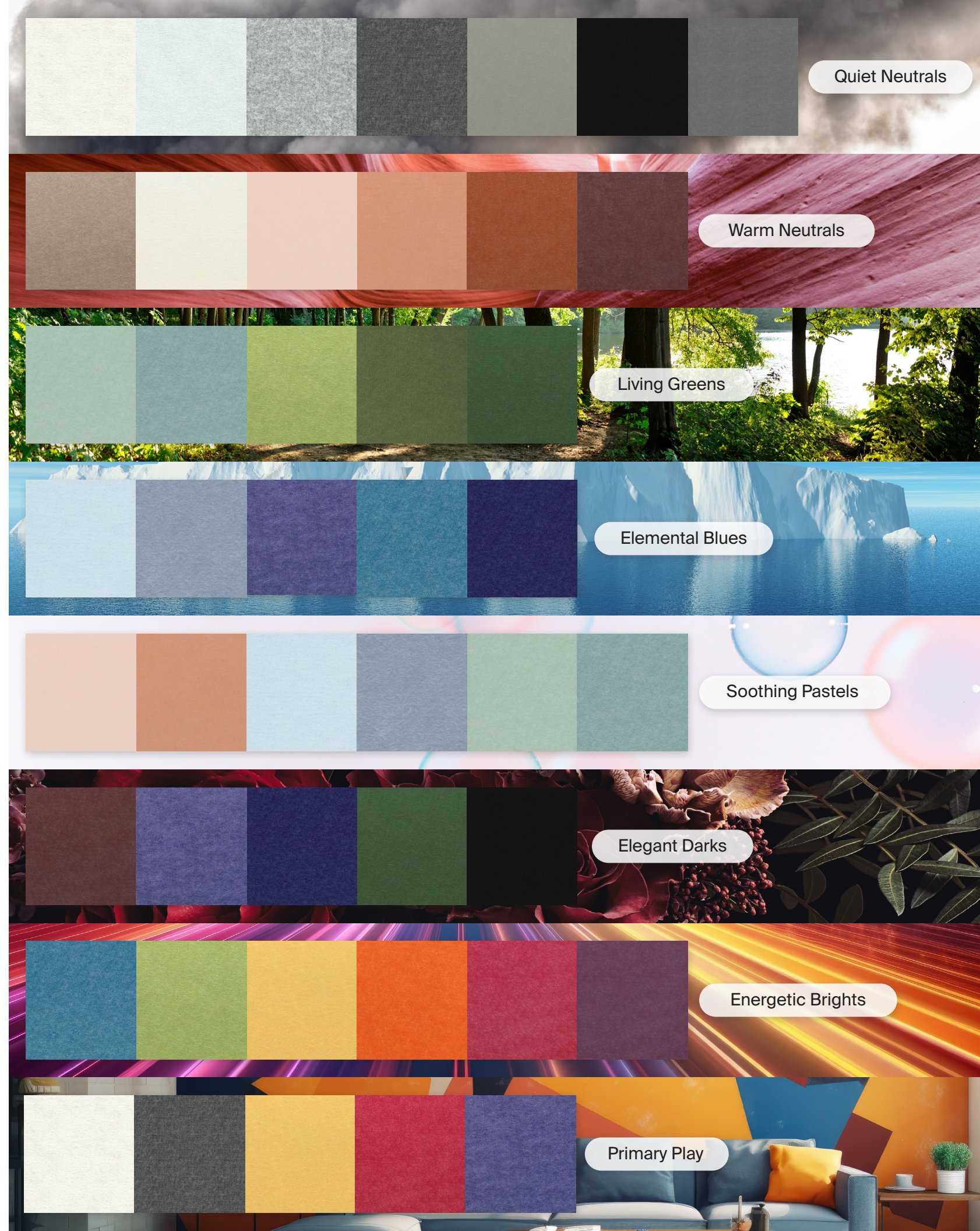

Quiet Neutrals

Warm Neutrals

Living Greens

Elemental Blues

Soothing Pastels

Elegant Darks

Energetic Brights

Primary Play

Play With Color

We firmly believe that a unique color concept can foster an unparalleled sense of comfort and identity when thoughtfully tailored to each space. To embrace this vision, our acoustic products offer a diverse range of colors, allowing you to personalize the components according to your preferences. With a wide array of standard finishes, you have the freedom to tailor the luminaire to your design preferences.



**We
are a group,
exclusively
distributing our
European partners
since 1981.**

Partner	Country	Architectural	Design	Exterior
Cangini & Tucci	Italy		<input type="radio"/>	
Cini & Nils	Italy		<input type="radio"/>	
Diamante	Italy			<input type="radio"/>
Fambuena	Spain		<input type="radio"/>	
Icane	Italy		<input type="radio"/>	
Ivela	Italy	<input type="radio"/>		
Knikerboker	Italy		<input type="radio"/>	
Letroh	Italy	<input type="radio"/>		
Linea Zero	Italy		<input type="radio"/>	
Milan	Spain		<input type="radio"/>	
Ole	Spain		<input type="radio"/>	
Panzeri	Italy		<input type="radio"/>	
Platek	Italy			<input type="radio"/>
Prolicht	Austria	<input type="radio"/>		
Quasar	Holland		<input type="radio"/>	
Side	Italy			<input type="radio"/>
Tunto	Finland		<input type="radio"/>	
Unonovesette	Italy			<input type="radio"/>
Zaneen	Canada		<input type="radio"/>	

You can click on the name of each Partner to discover their products on our website

zaneen.com