

PROJECT	_____
TYPE	_____
NOTES	_____
QUANTITY	_____
DATE	_____



ARCHITECTURAL | EPIQ

EPIQ is a suspension solution offering more than meets the eye. It's an acoustic panel that grants you the freedom to incorporate any downlight, including the OIKO PRO and INVADER COMPACT. Its distinctive shape elegantly merges form and function, complemented by sustainable acoustic materials. Epiq delivers the option of powerful illumination and remarkable flexibility paired with effective sound absorption and diffusion.



The adjustable downlights deliver light exactly where it is needed. The mechanism is easy to use and needs no tools to be adjusted. When the luminaire is tilted, no secondary light falls on the casing which avoids disturbing reflections.

SYSTEM OVERVIEW

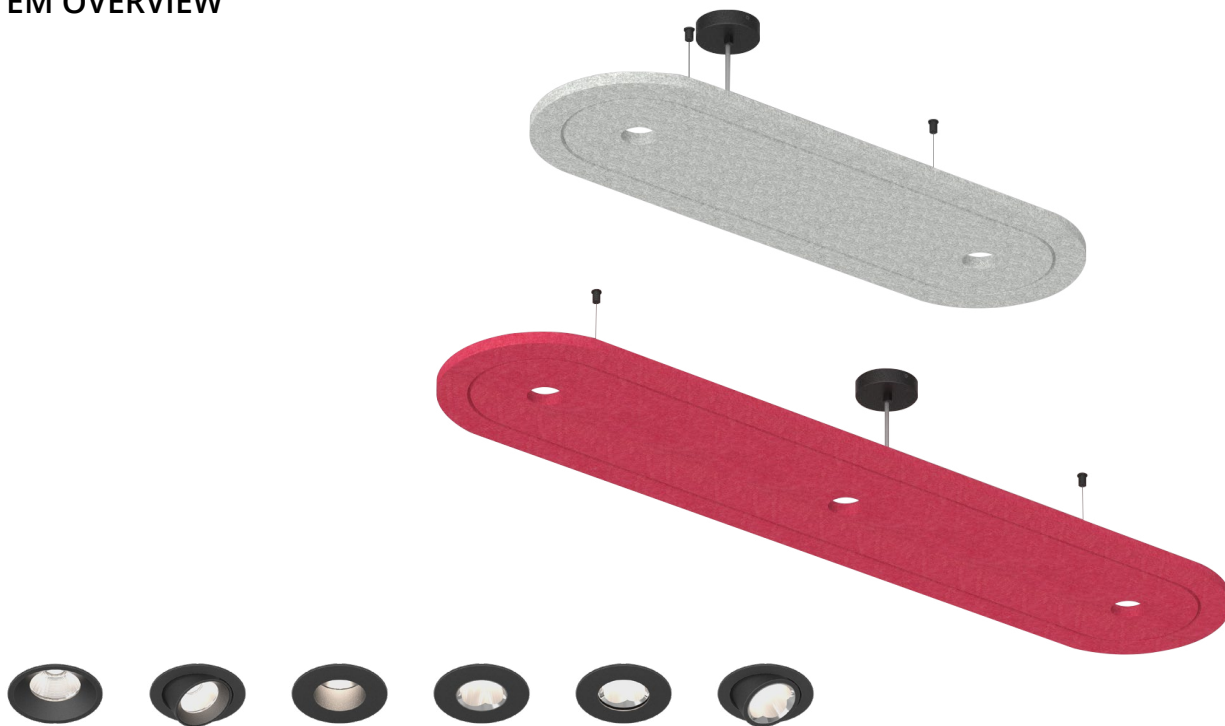

PROJECT _____
 TYPE _____
 NOTES _____
 QUANTITY _____
 DATE _____

SYSTEM GUIDE

To make your product selection and complete system specification, proceed with the following:
 review system options, create your system code in the field below and include your quantity.
 For the panels/inserts, use the field beside each product name.
 Submit to quotes@zaneen.com to receive a formal BOM and finalized model numbers.



UPON REQUEST
 Additional Options _____
 _____ Color Temperature
 _____ Special LED
 _____ RGB-W

EXAMPLE A3EPIQ-MOD-UNV-DN-01-01-2M

SYSTEM BUILD CODE: A3EPIQ-MOD- qty

ELECTRICAL	Voltage	Dimming	Circuit
	UNV - 120/277V	DN - Non Dim	EMCIR - Emergency Circuit
	120 - 120V	DP - Phase Dim (Triac/ELV)	
	347 - 347V	DV - 0-10V (100-1%)	
	DD - DALI (100-1%)		

LAYOUT	System Finishes	Cable Length
	Installation <input type="checkbox"/> _____ Power Feed <input type="checkbox"/> _____ <input type="checkbox"/> (27 colors) Clip 	2M - 2000mm 78 3/4" 6M - 6000mm 236 1/4"

MODULES	EPIQ PANELS	BUILD CODE EXAMPLE: A300386-ANC	FINISHES OPTIONS: See page 9 for acoustic color options and use 3 digit letters to indicate your choice
	EPIQ 1200 - 2 SPOTS	A300386-	qty
		Finish <input type="checkbox"/> _____ (32 colors -pg.9)	
	EPIQ 1800 - 3 SPOTS	A300387-	qty
		Finish <input type="checkbox"/> _____ (32 colors -pg.9)	

PROJECT	_____
TYPE	_____
NOTES	_____
QUANTITY	_____
DATE	_____

INSERTS

INVADER COMPACT

FINISHES OPTIONS:

See page 10 for color options and use 2 digit numbers to indicate your choices

INVADER COMPACT	A35811-					qty			
Wattage: 12W	Dimming	CCT - 90 CRI	Finish	Reflector	Optics	Delivered Lumen (lm)			
	DN - Non Dim	27K -2700K	◆ _____ (27 colors)	18 - 18°	00 - No optic 01 - Linear Spread 02 - Spread 03 - Honeycomb	CCT	18°	36°	56°
	DP - Phase Dim	30K - 3000K		2700K		1012	1010	1004	
	DV - 0-10V	35K - 3500K		3000K		1059	1057	1051	
		40K - 4000K		3500K		1098	1096	1090	
				4000K		1123	1120	1141	

INVADER COMP. NATURAL DIM	A35812-			qty	
Wattage: 11W	Finish	Reflector	Optics	Delivered Lumen (lm)	
	◆ _____ (27 colors)	16 - 16°	00 - No optic 01 - Linear Spread 02 - Spread 03 - Honeycomb	NATURAL DIM	
		36 - 36°		16°	894
		56 - 56°		36°	893
				56°	898

INVADER COMPACT ADJUSTABLE

INVADER COMP. ADJUSTABLE	A35813-				qty			
Wattage: 12W	Dimming	CCT - 90 CRI	Finish	Reflector	Delivered Lumen (lm)			
	DN - Non Dim	27K -2700K	◆ _____ ▲ _____ ● _____ (27 colors)	22 - 22°	CCT	22°	38°	48°
	DP - Phase Dim	30K - 3000K		38 - 38°	2700K	821	759	746
	DV - 0-10V	35K - 3500K		48 - 48°	3000K	860	794	781
		40K - 4000K			3500K	892	823	810
					4000K	911	842	828

INVADER COMP. ADJ. NATURAL DIM	A35814-			qty	
Wattage: 11W	Finish	Reflector	Delivered Lumen (lm)		
	◆ _____ ▲ _____ ● _____ (27 colors)	24 - 24°	NATURAL DIM		
		40 - 40°	24°	862	
		54 - 54°	40°	840	
			54°	825	

PROJECT	_____
TYPE	_____
NOTES	_____
QUANTITY	_____
DATE	_____

INSERTS

OIKO PRO ROUND

FINISHES OPTIONS:

See page 10 for color options and use 2 digit numbers to indicate your choices

Model	Code	Wattage	Dimming	CCT - 90 CRI	Finish	Optics	Delivered Lumen (lm)	
	A35867-	15.1W	DN - Non Dim DP - Phase Dim DV - 0-10V	27K -2700K 30K - 3000K 35K - 3500K 40K - 4000K	◆ _____ (27 colors)	00 - No optic 01 - Linear Spread 02 - Spread 03 - Honeycomb	qty	
							Delivered Lumen (lm)	
							CCT	34°
							2700K	1370
							3000K	1377
							3500K	1442
							4000K	1455
	A35871-	14.4W	Finish	◆ _____ (27 colors)	(27 colors)	00 - No optic 01 - Linear Spread 02 - Spread 03 - Honeycomb	qty	
							Delivered Lumen (lm)	
							TUNABLE WHITE	
							2700K-6500K (MAX)	
							36°	1129
	A35868-	15.1W	DN - Non Dim DP - Phase Dim DV - 0-10V	27K -2700K 30K - 3000K 35K - 3500K 40K - 4000K	◆ _____ (27 colors)	00 - No optic 01 - Linear Spread 02 - Spread 03 - Honeycomb	qty	
							Delivered Lumen (lm)	
							CCT	50°
							2700K	1455
							3000K	1462
							3500K	1531
							4000K	1545
	A35872-	14.4W	Finish	◆ _____ (27 colors)	(27 colors)	00 - No optic 01 - Linear Spread 02 - Spread 03 - Honeycomb	qty	
							Delivered Lumen (lm)	
							TUNABLE WHITE	
							2700K-6500K (MAX)	
							52°	1240
	A35869-	15.1W	DN - Non Dim DP - Phase Dim DV - 0-10V	27K -2700K 30K - 3000K 35K - 3500K 40K - 4000K	◆ _____ (27 colors)	00 - No optic 01 - Linear Spread 02 - Spread 03 - Honeycomb	qty	
							Delivered Lumen (lm)	
							CCT	60°
							2700K	1549
							3000K	1556
							3500K	1630
							4000K	1645

PROJECT	_____
TYPE	_____
NOTES	_____
QUANTITY	_____
DATE	_____

INSERTS

OIKO PRO ROUND

FINISHES OPTIONS:

See page 10 for color options and use 2 digit numbers to indicate your choices

	OIKO PRO 62° TW	A35873-		qty		
	Wattage: 14.4W	Finish	Optics		Delivered Lumen (lm)	
		◆ _____ (27 colors)	00 - No optic 01 - Linear Spread 02 - Spread 03 - Honeycomb		TUNABLE WHITE 2700K-6500K (MAX)	
					62° 1381	

	OIKO PRO SUPERSPOT	A35866-		qty		
	Wattage: 16W	Dimming	CCT - 90 CRI	Finish	Delivered Lumen (lm)	
		DN - Non Dim DP - Phase Dim DV - 0-10V	27K - 2700K 30K - 3000K 35K - 3500K 40K - 4000K	◆ _____ (27 colors)	CCT 14°	
					2700K 1067	
3000K 1150						
3500K 1217						
				4000K 1220		

OIKO PRO ROUND HIGH OUTPUT

	OIKO PRO HO 14°	A35837-		qty		
	Wattage: 21W	Dimming	CCT - 90 CRI	Finish	Delivered Lumen (lm)	
		DN - Non Dim DP - Phase Dim DV - 0-10V	27K - 2700K 30K - 3000K 35K - 3500K 40K - 4000K	◆ _____ (27 colors)	CCT 14°	
					2700K 1278	
3000K 1377						
3500K 1459						
				4000K 1461		

	OIKO PRO HO 34°	A35838-		qty			
	Wattage: 23.6W	Dimming	CCT - 90 CRI	Finish	Optics	Delivered Lumen (lm)	
		DN - Non Dim DP - Phase Dim DV - 0-10V	27K - 2700K 30K - 3000K 35K - 3500K 40K - 4000K	◆ _____ (27 colors)	00 - No optic 01 - Linear Spread 02 - Spread 03 - Honeycomb	CCT 34°	
						2700K 1936	
3000K 2005							
3500K 2098							
				4000K 2118			

	OIKO PRO HO 50°	A35839-		qty			
	Wattage: 23.6W	Dimming	CCT - 90 CRI	Finish	Optics	Delivered Lumen (lm)	
		DN - Non Dim DP - Phase Dim DV - 0-10V	27K - 2700K 30K - 3000K 35K - 3500K 40K - 4000K	◆ _____ (27 colors)	00 - No optic 01 - Linear Spread 02 - Spread 03 - Honeycomb	CCT 50°	
						2700K 2055	
3000K 2128							
3500K 2228							
				4000K 2248			

PROJECT
TYPE
NOTES
QUANTITY
DATE

OIKO PRO ROUND HIGH OUTPUT

FINISHES OPTIONS:

See page 10 for color options and use 2 digit numbers to indicate your choices

INSERTS

OIKO PRO HO 60°	A35840-				qty	
Wattage: 23.6W	Dimming	CCT - 90 CRI	Finish	Optics	Delivered Lumen (lm)	
	DN - Non Dim	27K -2700K	◆ — (27 colors)	00 - No optic 01 - Linear Spread 02 - Spread 03 - Honeycomb	CCT	60°
	DP - Phase Dim	30K - 3000K			2700K	2189
	DV - 0-10V	35K - 3500K			3000K	2267
		40K - 4000K			3500K	2372
					4000K	2394
OIKO PRO HO 16° IP54	A35849-				qty	
Wattage: 21W	Dimming	CCT - 90 CRI	Finish	Delivered Lumen (lm)		
	DN - Non Dim	27K -2700K	◆ — (27 colors)		CCT	16°
	DP - Phase Dim	30K - 3000K			2700K	1218
	DV - 0-10V	35K - 3500K			3000K	1312
		40K - 4000K			3500K	1391
					4000K	1392
OIKO PRO HO 36° IP54	A35850-				qty	
Wattage: 23.6W	Dimming	CCT - 90 CRI	Finish	Delivered Lumen (lm)		
	DN - Non Dim	27K -2700K	◆ — (27 colors)		CCT	36°
	DP - Phase Dim	30K - 3000K			2700K	1873
	DV - 0-10V	35K - 3500K			3000K	1939
		40K - 4000K			3500K	2030
					4000K	2049
OIKO PRO HO 50° IP54	A35851-				qty	
Wattage: 23.6W	Dimming	CCT - 90 CRI	Finish	Delivered Lumen (lm)		
	DN - Non Dim	27K -2700K	◆ — (27 colors)		CCT	50°
	DP - Phase Dim	30K - 3000K			2700K	1957
	DV - 0-10V	35K - 3500K			3000K	2027
		40K - 4000K			3500K	2121
					4000K	2141
OIKO PRO HO 60° IP54	A35852-				qty	
Wattage: 23.6W	Dimming	CCT - 90 CRI	Finish	Delivered Lumen (lm)		
	DN - Non Dim	27K -2700K	◆ — (27 colors)		CCT	60°
	DP - Phase Dim	30K - 3000K			2700K	2076
	DV - 0-10V	35K - 3500K			3000K	2150
		40K - 4000K			3500K	2251
					4000K	2272

PROJECT _____

TYPE _____

NOTES _____

QUANTITY _____

DATE _____

OIKO PRO ROUND ADJUSTABLE

FINISHES OPTIONS:

See page 10 for color options and use 2 digit numbers to indicate your choices

INSERTS

OIKO PRO ADJ. 52° TW	A35855-	qty	
Wattage: 14.4W	Finish	Delivered Lumen (lm)	
	◆ — ▲ — (27 colors)	TUNABLE WHITE	
		2700K-6500K (MAX)	
		52°	1240
	Optics		
	◆ —	00 - No optic	
	▲ —	01 - Linear Spread	
	(27 colors)	02 - Spread	
		03 - Honeycomb	

PROJECT	_____
TYPE	_____
NOTES	_____
QUANTITY	_____
DATE	_____

SYSTEM SUMMARY

System

Type

Suspension
Rated for Dry Locations Ceiling Mounted

Approval Status

Certified to North American Standards

Emission

Refer to emission icon beside each light insert and symbol legend for descriptions

Panels

Measurement

I. 1200mm (47 1/4") x w. 400mm (15 3/4") x ht. 24mm (1 5/16") with 2xØ68mm (2 1/16") Cut out for Downlights
I. 1800mm (70 7/8") x w. 400mm (15 3/4") x ht. 24mm (1 5/16") with 3xØ68mm (2 1/16") Cut out for Downlights

Suspension Lengths

Standard lengths include 2000mm and 6000mm
Any custom length must be pre-cut on site
Maximum custom length available is 10000mm

Electrical

Connections

Luminaries are pre-wired by factory

Power Feed

Located in the center of the ceiling holder
3 Wires - non-dimming or phase dimming
4 Wires - two circuits of non-dimming or phase dimming
5 Wires - 0-10V dimming or dali dimming

LED Driver

Located next to driver in the middle of acoustic panel
Electronic Class 2 driver, Universal 120V/277V
Non-Dimming Driver, Phase Dimming Driver, and 0-10V Dimming Driver (10-100%)
Consult factory for driver cutsheet
If a different driver is required, please specify

Emergency Inverter Compatible

To be installed remotely, and provided by others
It can be located up to 250m away from the fixture

Emergency circuit wiring is available upon request (Isolated track with dedicated driver used for emergency circuit will connect to emergency battery pack - supplied by others)

General

Features

Epiq is a uniquely shaped suspension lighting solution that features compact downlights within the sophisticated design and sustainable acoustic material. A dynamic solution for a variety of environments, Oiko and Invader downlights deliver high output and great flexibility while the acoustic panels provide sound absorption and diffusion to create an ideal opportunity for either work or play.

The acoustic material of the panels is available in 32 colors while the downlights can be individualized in 27 colors to meet the demands of a space while not sacrificing on design options.

Custom Requests and Additional Options

Availability depends on insert, system, and configuration
Must consult factory and allow up to 5 business days for an answer

Color temperature, RGB-W, special LEDs

Warranty

ZANEEN provides a limited warranty from date of purchase to original purchaser

LED Inserts: 5 year tested for 50,000 hours at 70% lumen output (L70)

LED Driver: 5 year

Non-Electrical Components: 1 year

*Check boxes to complete specification order and submit to quotes@zaneen.com to receive a formal BOM and a finalized model number

*In a constant effort to supply the best product, we reserve the right to change specifications or materials without notice. The most recent specification sheets are found at zaneen.com

PROJECT _____
 TYPE _____
 NOTES _____
 QUANTITY _____
 DATE _____

ACOUSTIC PANEL COLORS

Anchor - **ANC**

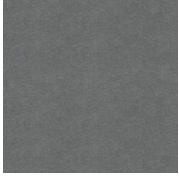

Ash - **ASH**

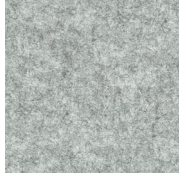

Ballerina - **BNA**

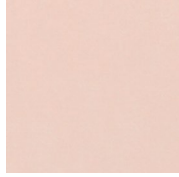

Baltic - **BTC**



Breeze - **BZE**



Celadon - **CEL**



Eggshell - **EGG**



Evergreen - **EVG**



Fog - **FOG**



Fossil - **FOS**



Frost - **FST**

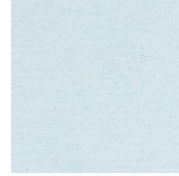

Fuchsia - **FUA**



Iris - **IRI**

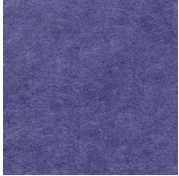

Iron - **IRO**

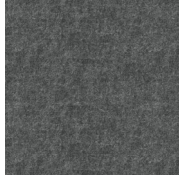

Khaki - **KHA**



Lichen - **LIC**

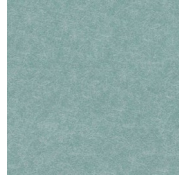

Lime - **LIM**



Merlot - **MER**



Muslin - **MSN**

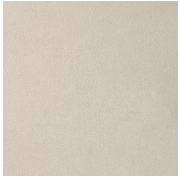

Mustard - **MUS**



Onyx - **ONX**

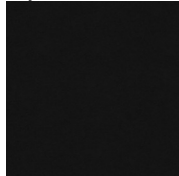

Peach - **PEA**



Plum - **PLU**



Polar - **POL**



Poppy - **PPY**



Ray - **RAY**

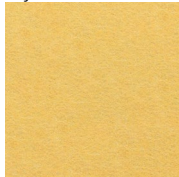

Royal - **ROY**



Rust - **RST**



Steel - **STE**



Seaweed - **SWD**



Tangerine - **TAN**



Taupe - **TAU**

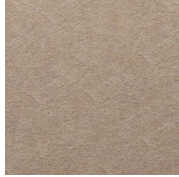

PROJECT _____

TYPE _____

NOTES _____

QUANTITY _____

DATE _____

FINISH COLORS



Sparkling Silver - 01

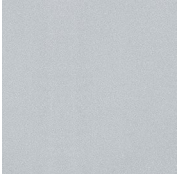

Black Velvet - 02

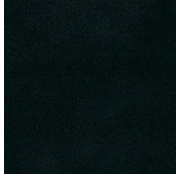

Crystal White - 03

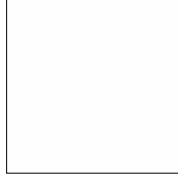

Creamy - 04



Hampton Bay - 05

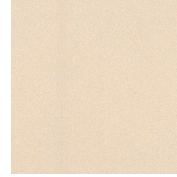

Urban Forest - 07



In the Army - 08



Rusty Angel - 09



Fade to Grey - 12

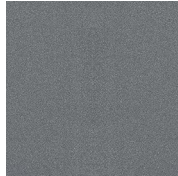

Mysterious Grey - 13

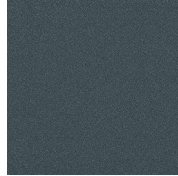

Lost Dream - 15

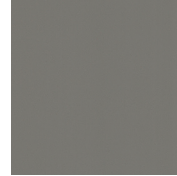

Purple Sky - 16



Fresh Oh - 17



Funky P - 18



Kissing Aphrodite - 19



Poseidon's Paradise - 20

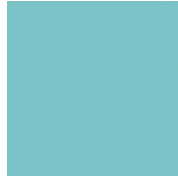

Blue Sky - 21



Spring Green - 22



Mellow Yellow - 23



Golden Heart - 24



Champagne Cream - 26



Copper Mine - 27



Ancient Bronze - 28



Jazz Gold - 29



Olive Breeze - 30

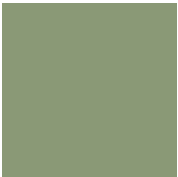

Moonlight Silver - 31



Rosewood Red - 32



Digital: Not all screens are calibrated the same, and therefore, colors will appear differently between screens.





































































Physical: When texture is involved, there will be variations in color, character and tone within a product series and between product families.

Champagne Cream, Copper Mine, Ancient Bronze + Jazz Gold: These finishes have slight fading from specific powder coating production. Each luminaire will slightly vary.











RAL Color Upon Request













LEGEND

	floor-mounted		pivotal		special LED (upon request) RGB, RGBW, tunable, gold+, meat+, art+, fashion+
	wall and ceiling: recessed and surface mounted		rotating		warm dim / natural dimming LED
	ceiling-mounted and wall-mounted		illuminate tilted		rechargeable battery powered
	wall-mounted		color of suspension cable		fixture with natural vivid LED (upon request)
	omni-directional light distribution		length of suspension cable		color rendering index
	direct light distribution		reflector degree selection		color temperature
	direct/indirect light distribution		super spot		lumen (luminous flux)
	indirect light distribution		lens		efficacy (lumens per watt)
	asymmetric light distribution		lens pack		Unified Glare Rating (UGR) range from 5-40
	aura light distribution		shine ring		marine grade (AISI 316 stainless steel)
	round wall or ceiling cut-out		integrated shine ring with diffuser		walk on
	square wall or ceiling cut-out		free individual colors 01-29		drive on
	the supplied jig specifies the cutout dimensions		individual colors: 00 (free of charge), 01-25 (extra charge)		Dark Sky Compliance
	minimum distance (meters) lamp - object		luminaire part to be colored (F1)		Americans with Disabilities Act (less than 4" off the wall located between 27"-84" from floor)
	recessed depth		luminaire part to be colored (F2)		lamp protected against explosion
	ceiling thickness in mm		luminaire part to be colored (F3)		blown glass using traditional methods by master glass blower
	ceiling thickness selection		luminaire part to be colored (F4)		acoustic material
	dimnable DP (phase), DV (0-10V), DD (dali), DS (step-dim)		luminaire part to be colored (F5)		protection class I, protection insulation
	included or excluded LED driver/transformer/control gear		color of 3-circuit adaptor		protection class II, protection insulation
	separately switchable		indirect diffuser		ETL Certified to UL and CSA Standards
	sensor		direct diffuser		UL Certified to UL and CSA Standards
	remote control		ball-proof (upon request)		CSA Certified to UL and CSA Standards
	available upon request		accessory		Certified for North American Standards

IP RATING

	protected against ingress of solid bodies greater than 12.5mm (finger)
	protected against ingress of solid bodies greater than 2.5mm protected against sprays of water up to 60 degrees from the vertical (rain)
	protected against ingress of solid bodies greater than 1mm (wire) no protection against the ingress of moisture
	protected against ingress of solid bodies greater than 1mm (wire) protected against sprays of water up to 60 degrees from the vertical (rain)
	protected against ingress of solid bodies greater than 1mm (wire) protected against water splashed from all directions
	protected against limited ingress of dust (wet rooms/covered outdoor areas) protected against water splashed from all directions
	protected against ingress of dust protected against jets of water
	protected against ingress of dust protected against powerful jets of water or heavy seas
	protected against ingress of dust protected against immersion of water between 15cm - 1m for 30 minutes
	protected against ingress of dust protected against immersion of water under pressure for long periods

IK RATING

	protected against 0.14 joules impact (equivalent to 0.25kg mass dropped from 56mm above the surface)
	protected against 0.2 joules impact (equivalent to 0.25kg mass dropped from 80mm above the surface)
	protected against 0.35 joules impact (equivalent to 0.25kg mass dropped from 140mm above the surface)
	protected against 0.5 joules impact (equivalent to 0.25kg mass dropped from 200mm above the surface)
	protected against 0.7 joules impact (equivalent to 0.25kg mass dropped from 280mm above the surface)
	protected against 1 joules impact (equivalent to 0.25kg mass dropped from 400mm above the surface)
	protected against 2 joules impact (equivalent to 0.5kg mass dropped from 400mm above the surface)
	protected against 5 joules impact (equivalent to 1.7kg mass dropped from 300mm above the surface)
	protected against 10 joules impact (equivalent to 5.0kg mass dropped from 200mm above the surface)
	protected against 20 joules impact (equivalent to 5.0kg mass dropped from 400mm above the surface)

WIRING DIAGRAMS

ALL ZANEEN FIXTURES ARE MANUFACTURED TO NORTH AMERICAN ELECTRICAL STANDARDS

Post Sales Support
HQ 1-800-388-3382 X 625 support@zaneen.com

IMPORTANT

- Do NOT connect directly to line voltage
- There is a minimum and maximum load per driver (See fixture and driver specifications).
- Fixture MUST be connected to LED driver, prior to turning power on

PHASE/NON-DIMMING WIRING DIAGRAM

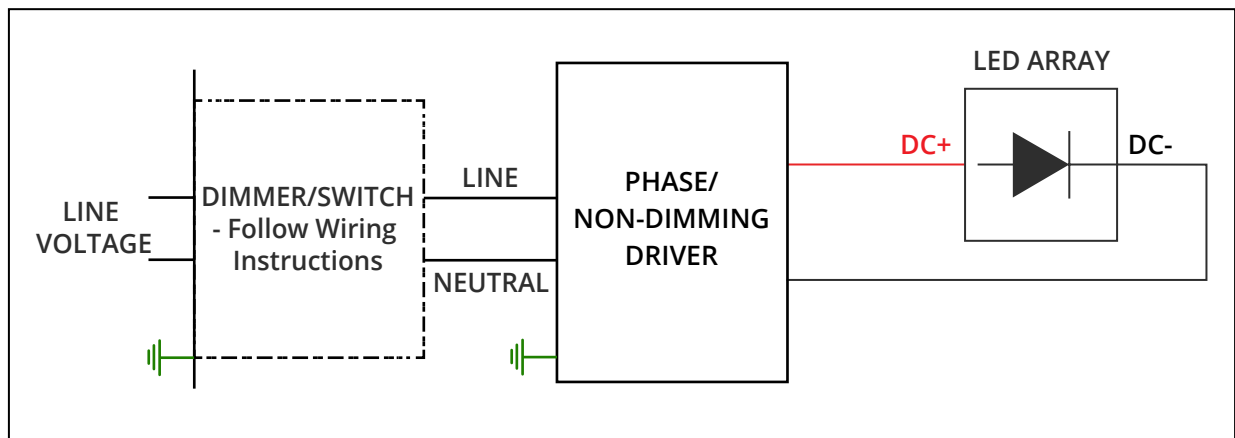

0-10V DIMMING WIRING DIAGRAM

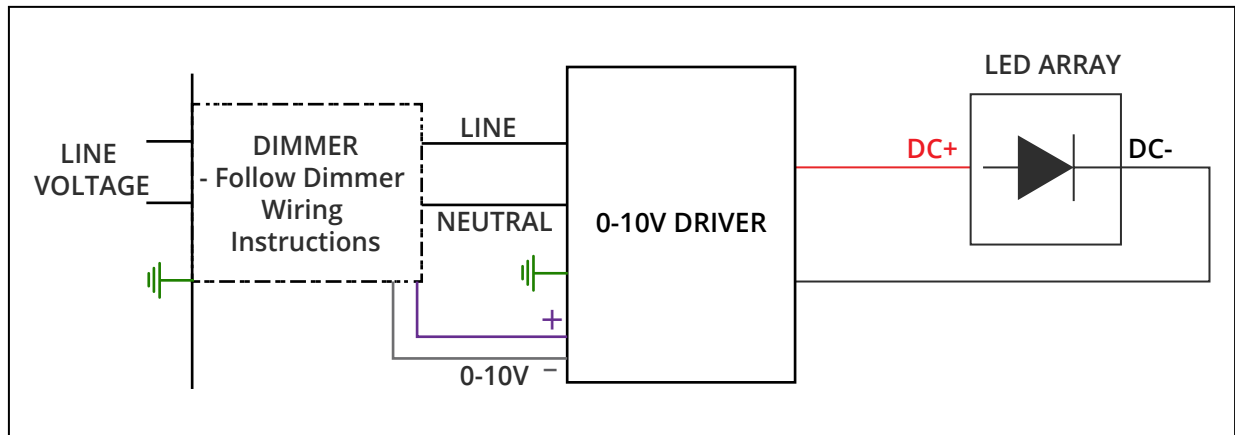

PROJECT _____
TYPE _____
NOTES _____
QUANTITY _____
DATE _____

Insert custom drawing here or attach with additional pages

