

## GROOVE SUSPENSION SYSTEM SPECIFICATION SHEET

PROJECT \_\_\_\_\_  
 TYPE \_\_\_\_\_  
 NOTES \_\_\_\_\_  
 QUANTITY \_\_\_\_\_  
 DATE \_\_\_\_\_

ARCHITECTURAL

The GROOVE reinforces modern building architecture with bright lines of light. It's characterized by its distinctive design that uses fresh, bold colors to set a new course. The LED system is easy to install in many rooms whether for office applications or in spacious foyer settings. The optional KORONA EFFECT and other freely configurable color options (exterior profile, canopy, end cap and suspension mounting clips) give free rein for creativity

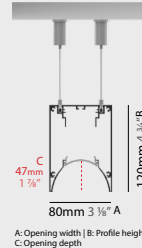

The recessed, curved diffuser and the specially adapted construction of the mixing chamber guarantee high visual comfort. The internal reflector is made of a microcellular reflective sheet material with an increased reflectance of 97%, which improves the efficiency of Groove

PROLICHT

UPON REQUEST

- Additional Options**
- Color Temperature
  - CRI 90
  - RGB-W / Tunable
  - Different Output
  - Individual Sizes
  - Engraving Letters & Signs



### BUILDING GUIDE

Check boxes to complete specification order and submit to [quotes@zaneen.com](mailto:quotes@zaneen.com) to receive a formal BOM and finalized model number. For specification purposes, build a unique model number with bold text [30K - DIR - OP - ...]

Quick Ship (QS) - Not Available

Build Code **L3GR-SUS-SYS-**

Product	Color Temperature	Distribution	Diffuser	Cable	Length
<b>L3GR-SUS-SYS</b> Suspension	<b>30K</b> 3000K	<b>DIR</b> Direct	<b>FD</b> Flat Opal	<b>2M</b> 2000mm	<b>Alum Profile System</b> length Specify in mm length Specify in 'X'-X" qty
	<b>35K</b> 3500K		<b>CD</b> Curved Opal	<b>6M</b> 6000mm	
	<b>40K</b> 4000K			<b>XM</b> Custom (Upon Request)	
					<b>PAT</b> Pattern/Design Ambition (Consult Factory with Drawings) qty

PROFILE - SYSTEM

Electrical	Input Voltage	Emergency	Finish	
<b>DN</b> Non-Dimming	<b>UNV</b> Universal 120V / 277V	<b>EMCIR</b> Emergency Circuit	<b>Profile</b> ◆ 00-29	<b>Profile Korona</b> ▲ 01-29
<b>DP</b> Phase Dimming			<b>End Cap</b> ◆ 00-29 ▲ 00-29	<b>Power Feed</b> ◆ 01-29
<b>DV</b> 0-10 Dimming			<b>Cap Profile</b> ◆ 00-29	
<b>DD</b> Dali Dimming (Upon Request)			<b>Suspension Cable</b> ◆ 01-29	

PROFILE - SYSTEM

refer to color chart  
 refer to inserts to build code  
 RAL color # (upon request)

## GROOVE SUSPENSION SYSTEM SPECIFICATION SHEET

Build Code <b>L30506-</b>		Dimension		Finish	qty		
mm		mm					
ALUMINIUM PROFILE		W: 80	per meter	◆ 00-29			
		H: 120	max 3000mm field-cutttable	▲ 00-29			
Build Code <b>L38997-</b>		Dimension		Finish	qty		
mm		mm					
END CAP		6 x 80		◆ 00-29			
		H: 120		▲ 00-29			
Build Code <b>L3993200</b>		Dimension			qty		
mm		mm					
LINEAR COUPLER		200 x 77	1 Pair				
		H: 79					
Build Code <b>L3906 _ -</b>		Dimension		Build Code Addition	Finish	Suspension	qty
mm		mm <sup>2</sup>					
SUSPENSION CABLE		Ø20	1 Pair	6 6	◆ 01-29	200	
		L: 2000	quick release fastener			↓ 2000mm	
		Ø20		6 4		600	
		L: 6000				↓ 6000mm	
						XM	
						↓ Custom	
Build Code <b>L390 _ _ -</b>		Dimension		Build Code Addition	Finish	Suspension	qty
mm		mm <sup>2</sup>					
Y-SUSPENSION CABLE		Ø20	quick release fastener	0 7 7	◆ 01-29	200	
		L: 2000				↓ 2000mm	
		Ø20		0 6 5		600	
		L: 6000				↓ 6000mm	
						XM	
						↓ Custom	

## GROOVE SUSPENSION SYSTEM SPECIFICATION SHEET

PROJECT \_\_\_\_\_  
 TYPE \_\_\_\_\_  
 NOTES \_\_\_\_\_  
 QUANTITY \_\_\_\_\_  
 DATE \_\_\_\_\_

Build Code <b>L3901 _ -</b>		Dimension		Build Code Addition	Finish	Suspension	qty
		mm	mm <sup>2</sup>				
POWER FEED		↑ Ø114 H: 32 L: 2000	3 x 0.75	<b>1 3</b> <b>1 4</b> <b>1 5</b> <b>1 6</b> <b>1 7</b> <b>1 8</b>	◆ <b>01-29</b>	<b>200</b> ↓ 2000mm	
			5 x 0.75				
			4 x 0.75				
			3 x 0.75				
		↑ Ø114 H: 32 L: 6000	3 x 0.75			<b>600</b> ↓ 6000mm	
			5 x 0.75				
			4 x 0.75				

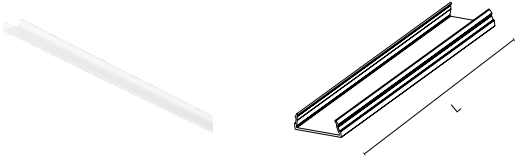

Build Code <b>L3964300-</b>		Dimension		Build Code Addition	Finish	Suspension	qty
		mm					
FLAT OPAL DIFFUSER		↑ ▲ <b>W: 42 H: 14</b>	per meter				
			max 3000mm field-cutttable				



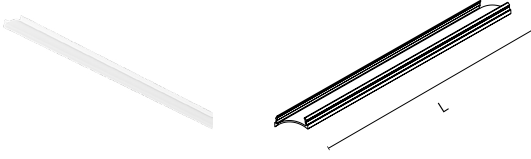



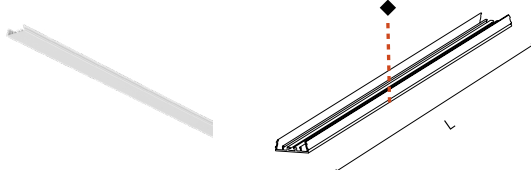





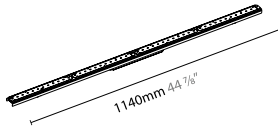



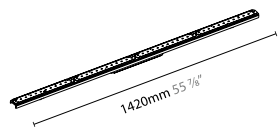

Build Code <b>L3993000-</b>		Dimension		Build Code Addition	Finish	Suspension	qty
		mm					
CURVED OPAL		↑ ▲ <b>W: 42 H: 14</b>	per meter				
			max 3000mm field-cutttable				

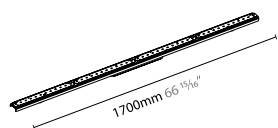
Build Code <b>L39931-</b>		Dimension		Build Code Addition	Finish	Suspension	qty
		mm					
CAP PROFILE		↑ ▲ <b>W: 42 H: 14</b>	per meter		◆ <b>00-29</b>		
			max 3000mm field-cutttable				

## GROOVE SUSPENSION SYSTEM SPECIFICATION SHEET

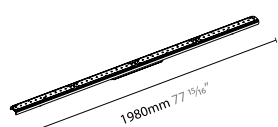
PROJECT	_____
TYPE	_____
NOTES	_____
QUANTITY	_____
DATE	_____

Build Code <b>L38524-</b>									qty
GROOLINE			Wattage	Delivered Lumens	CRI	Dimming	Color Temperature	Diffuser	
				<b>20.2</b> 20.2W	<b>1370</b> 1370lm <b>1418</b> 1418lm <b>1447</b> 1447lm	<b>80</b>	<b>DN</b> Non-Dim <b>DP</b> Phase <b>DV</b> 0-10V	<b>30K</b> 3000K <b>35K</b> 3500K <b>40K</b> 4000K	
Build Code <b>L38526-</b>									qty
GROOLINE			Wattage	Delivered Lumens	CRI	Dimming	Color Temperature	Diffuser	
				<b>25.3</b> 25.3W	<b>1712</b> 1712lm <b>1773</b> 1773lm <b>1809</b> 1809lm	<b>80</b>	<b>DN</b> Non-Dim <b>DP</b> Phase <b>DV</b> 0-10V	<b>30K</b> 3000K <b>35K</b> 3500K <b>40K</b> 4000K	
Build Code <b>L38528-</b>									qty
GROOLINE			Wattage	Delivered Lumens	CRI	Dimming	Color Temperature	Diffuser	
				<b>30.4</b> 30.4W	<b>2055</b> 2055lm <b>2126</b> 2126lm <b>2170</b> 2170lm	<b>80</b>	<b>DN</b> Non-Dim <b>DP</b> Phase <b>DV</b> 0-10V	<b>30K</b> 3000K <b>35K</b> 3500K <b>40K</b> 4000K	
Build Code <b>L38530-</b>									qty
GROOLINE			Wattage	Delivered Lumens	CRI	Dimming	Color Temperature	Diffuser	
				<b>35.4</b> 35.4W	<b>2397</b> 2397lm <b>2481</b> 2481lm <b>2532</b> 2532lm	<b>80</b>	<b>DN</b> Non-Dim <b>DP</b> Phase <b>DV</b> 0-10V	<b>30K</b> 3000K <b>35K</b> 3500K <b>40K</b> 4000K	
Build Code <b>L38532-</b>									qty
GROOLINE			Wattage	Delivered Lumens	CRI	Dimming	Color Temperature	Diffuser	
				<b>40.5</b> 40.5W	<b>2740</b> 2740lm <b>2836</b> 2836lm <b>2894</b> 2894lm	<b>80</b>	<b>DN</b> Non-Dim <b>DP</b> Phase <b>DV</b> 0-10V	<b>30K</b> 3000K <b>35K</b> 3500K <b>40K</b> 4000K	

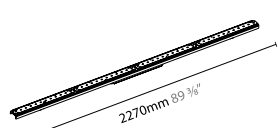
PROJECT \_\_\_\_\_  
 TYPE \_\_\_\_\_  
 NOTES \_\_\_\_\_  
 QUANTITY \_\_\_\_\_  
 DATE \_\_\_\_\_

### FINISH COLORS 00-29

Anodized Aluminum - 01

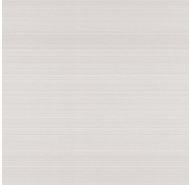

Sparkling Silver - 01



Black Velvet - 02



Crystal White - 03



Creamy - 04

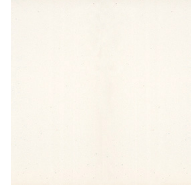

Hampton Bay - 05



Lagoon - 06



Urban Forest - 07



In the Army - 08

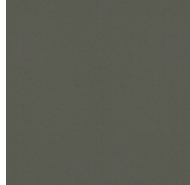

Rusty Angel - 09



Rusty Rush - 10



Milk and Chocolate - 11



Fade to Gray - 12

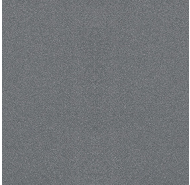

Mysterious Gray - 13



Twilight - 14



Lost Dream - 15



Purple Sky - 16



Fresh Oh - 17



Funky P. - 18



Kissing Aphrodite - 19



Poseidon's Paradise - 20



Blue Sky - 21



Spring Green - 22

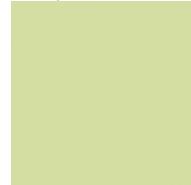

Mellow Yellow - 23

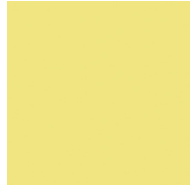

Golden Heart - 24



Gun Metal - 25



Champagne Cream - 26



Copper Mine - 27



Ancient Bronze - 28



Jazz Gold - 29



**Digital:** Not all screens are calibrated the same, and therefore, colors will appear differently between screens.

**Physical:** When texture is involved, there will be variations in color, character and tone within a product series and between product families.





































































**Gun Metal:** No Gun Metal finish is alike. It combines a mixture of transparent and black color particles which ensures a highly individual effect and no luminaire being identical.

**Champagne Cream, Copper Mine, Ancient Bronze + Jazz Gold:** These finishes have slight fading from specific powder coating production. Each luminaire will slightly vary.











RAL Color Upon Request













### LEGEND

	floor-mounted		pivotal		special LED (upon request) RGB, RGBW, tunable, gold+, meat+, art+, fashion+
	wall and ceiling: recessed and surface mounted		rotating		warm dim / natural dimming LED
	ceiling-mounted and wall-mounted		illuminate tilted		rechargeable battery powered
	wall-mounted		color of suspension cable		fixture with natural vivid LED (upon request)
	omni-directional light distribution		length of suspension cable		color rendering index
	direct light distribution		reflector degree selection		color temperature
	direct/indirect light distribution		super spot		lumen (luminous flux)
	indirect light distribution		lens		efficacy (lumens per watt)
	asymmetric light distribution		lens pack		Unified Glare Rating (UGR) range from 5-40
	aura light distribution		shine ring		marine grade (AISI 316 stainless steel)
	round wall or ceiling cut-out		integrated shine ring with diffuser		walk on
	square wall or ceiling cut-out		free individual colors 01-29		drive on
	the supplied jig specifies the cutout dimensions		individual colors: 00 (free of charge), 01-25 (extra charge)		Dark Sky Compliance
	minimum distance (meters) lamp - object		luminaire part to be colored (F1)		Americans with Disabilities Act (less than 4" off the wall located between 27"-84" from floor)
	recessed depth		luminaire part to be colored (F2)		lamp protected against explosion
	ceiling thickness in mm		luminaire part to be colored (F3)		blown glass using traditional methods by master glass blower
	ceiling thickness selection		luminaire part to be colored (F4)		acoustic material
	dimmable DP (phase), DV (0-10V), DD (dali), DS (step-dim)		luminaire part to be colored (F5)		protection class I, protection insulation
	included or excluded LED driver/transformer/control gear		color of 3-circuit adaptor		protection class II, protection insulation
	separately switchable		indirect diffuser		ETL Certified to UL and CSA Standards
	sensor		direct diffuser		UL Certified to UL and CSA Standards
	remote control		ball-proof (upon request)		CSA Certified to UL and CSA Standards
	available upon request		accessory		Certified for North American Standards

### IP RATING

	protected against ingress of solid bodies greater than 12.5mm (finger)
	protected against ingress of solid bodies greater than 2.5mm protected against sprays of water up to 60 degrees from the vertical (rain)
	protected against ingress of solid bodies greater than 1mm (wire) no protection against the ingress of moisture
	protected against ingress of solid bodies greater than 1mm (wire) protected against sprays of water up to 60 degrees from the vertical (rain)
	protected against ingress of solid bodies greater than 1mm (wire) protected against water splashed from all directions
	protected against limited ingress of dust (wet rooms/covered outdoor areas) protected against water splashed from all directions
	protected against ingress of dust protected against jets of water
	protected against ingress of dust protected against powerful jets of water or heavy seas
	protected against ingress of dust protected against immersion of water between 15cm - 1m for 30 minutes
	protected against ingress of dust protected against immersion of water under pressure for long periods

### IK RATING

	protected against 0.14 joules impact (equivalent to 0.25kg mass dropped from 56mm above the surface)
	protected against 0.2 joules impact (equivalent to 0.25kg mass dropped from 80mm above the surface)
	protected against 0.35 joules impact (equivalent to 0.25kg mass dropped from 140mm above the surface)
	protected against 0.5 joules impact (equivalent to 0.25kg mass dropped from 200mm above the surface)
	protected against 0.7 joules impact (equivalent to 0.25kg mass dropped from 280mm above the surface)
	protected against 1 joules impact (equivalent to 0.25kg mass dropped from 400mm above the surface)
	protected against 2 joules impact (equivalent to 0.5kg mass dropped from 400mm above the surface)
	protected against 5 joules impact (equivalent to 1.7kg mass dropped from 300mm above the surface)
	protected against 10 joules impact (equivalent to 5.0kg mass dropped from 200mm above the surface)
	protected against 20 joules impact (equivalent to 5.0kg mass dropped from 400mm above the surface)

PROJECT	_____
TYPE	_____
NOTES	_____
QUANTITY	_____
DATE	_____

### SYSTEM SUMMARY

#### System

**Type**  
Suspension  
Rated for Dry Locations Ceiling Mounted

**Approval Status**  
CSA Certified to CSA and UL Standards

**Emission**  
Refer to emission icon beside each light insert and symbol legend for descriptions

**Efficiency**  
Acrylic Opal Diffuser (snap-in) lens 43%

#### Profile

**Measurement**  
w 80mm (3 1/8") x ht. 120mm (4 3/4")

**Housing**  
Anodized extruded aluminum profile available per meter and field-cutttable  
Profiles have a maximum length of 3000mm (9' 10 1/4") and joined together with couplers to ensure uniform appearance and easy installation

**Suspension Lengths**  
Standard lengths include 2000mm and 6000mm  
Any custom length must be pre-cut on site  
Maximum custom length available is 10000mm

#### Electrical

**Connections**  
Luminaires are pre-wired with a factory installed branch circuit wiring and quick-release connectors  
Through wiring is used to connect the luminaires

**Power Feed**  
Located 2 inches from one end of the fixture, on top of the profile  
If a different location is required, please specify  
3 Wires - non-dimming or phase dimming  
4 Wires - two circuits of non-dimming or phase dimming  
5 Wires - 0-10V dimming or dali dimming

**LED Driver**  
Integrated with inserts  
Electronic Class 2 driver, Universal 120V/277V  
Non-Dimming Driver, Phase Dimming Driver, and 0-10V Dimming Driver (10-100%)  
Consult factory for driver cutsheet  
If a different driver is required, please specify

**Emergency Inverter Compatible**  
To be installed remotely, and provided by others  
It can be located up to 250m away from the fixture

Emergency circuit wiring is available upon request (Isolated track with dedicated driver used for emergency circuit will connect to emergency battery pack - supplied by others)

#### General

**Features**  
Whether text, symbols, or branding, IDENTITY allows the luminaire to be customized on request with cut-outs along its entire length. Easily the best solution to be creative and make a space unique for branding, organizing, and motivation. Identity engraving for letters and signs have a standard price per character

The recessed, curved diffuser and the specially adapted construction of the mixing chamber guarantee high visual comfort

The new internal reflector is made of microcellular reflective sheet material with an increased reflectance of 97%, which improves the efficiency of Groove

The curved diffuser is installed deep in the luminaire. The curved side flanks inside the luminaire allow a special accentuation in the 30 colors of your choice

#### Custom Requests and Additional Options

Availability depends on insert, system, and configuration  
Must consult factory and allow up to 5 business days for an answer

Color temperature, Special CRI, RGB-W, tunable, individual sizes, special diffuser, light inserts with different outputs, light inserts on different circuits

#### Configuration

Consult factory for patterns or custom designs  
Provide configuration drawings

\*Shop drawings provided upon receiving purchase order

#### Warranty

ZANEEN provides a limited warranty from date of purchase to original purchaser

**LED Inserts** : 5 year tested for 50,000 hours at 70% lumen output (L70)

**LED Driver** : 5 year

**Non-Electrical Components** : 1 year

\*Check boxes to complete specification order and submit to [quotes@zaneen.com](mailto:quotes@zaneen.com) to receive a formal BOM and a finalized model number

\*In a constant effort to supply the best product, we reserve the right to change specifications or materials without notice. The most recent specification sheets are found at [zaneen.com](http://zaneen.com)

PROJECT	_____
TYPE	_____
NOTES	_____
QUANTITY	_____
DATE	_____

### SYSTEM SUMMARY

#### Inserts

\*Delivered lumens is the maximum possible; using most efficient diffuser

#### Linears

##### Grooline

Wattage: 20.2W - 40.5W

Lumen: 1370lm - 2894lm

Color Temperature: 30K, 35K, 40K

Length: 1140mm (44 7/8") - 2270mm (89 3/8")



# WIRING DIAGRAMS

ALL ZANEEN FIXTURES ARE MANUFACTURED TO NORTH AMERICAN ELECTRICAL STANDARDS

Post Sales Support  
HQ 1-800-388-3382 X 625 support@zaneen.com

### IMPORTANT:

- Do NOT connect directly to line voltage
- There is a minimum and maximum load per driver (See fixture and driver specifications).
- Fixture MUST be connected to LED driver, prior to turning power on

### PHASE/NON-DIMMING WIRING DIAGRAM

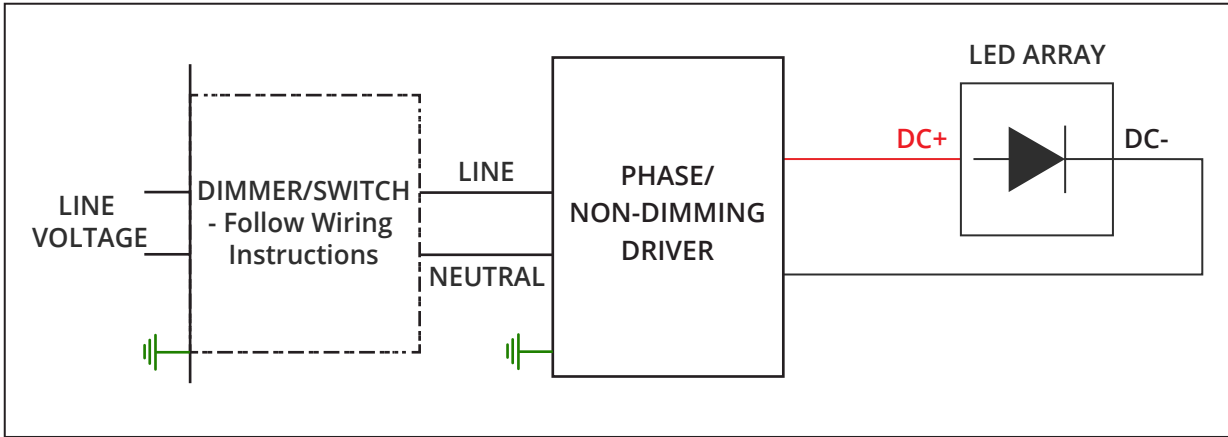

### 0-10V DIMMING WIRING DIAGRAM

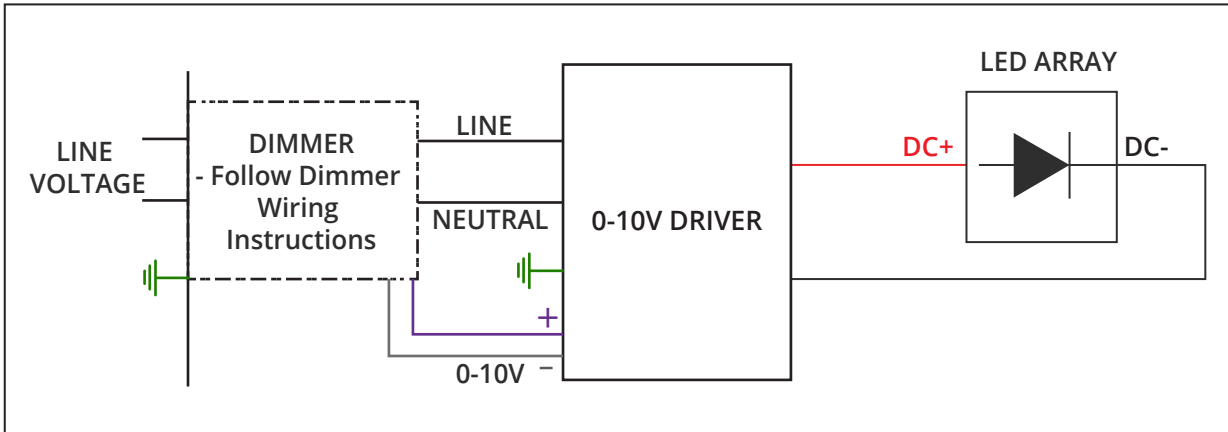



**GROOVE** SUSPENSION SYSTEM  
SPECIFICATION SHEET

PROJECT \_\_\_\_\_  
TYPE \_\_\_\_\_  
NOTES \_\_\_\_\_  
QUANTITY \_\_\_\_\_  
DATE \_\_\_\_\_

INSERT CUSTOM DRAWING HERE OR ATTACH WITH ADDITIONAL PAGES

