

IDAHO 40 SURFACE SYSTEM SPECIFICATION SHEET

PROJECT	_____
TYPE	_____
NOTES	_____
QUANTITY	_____
DATE	_____

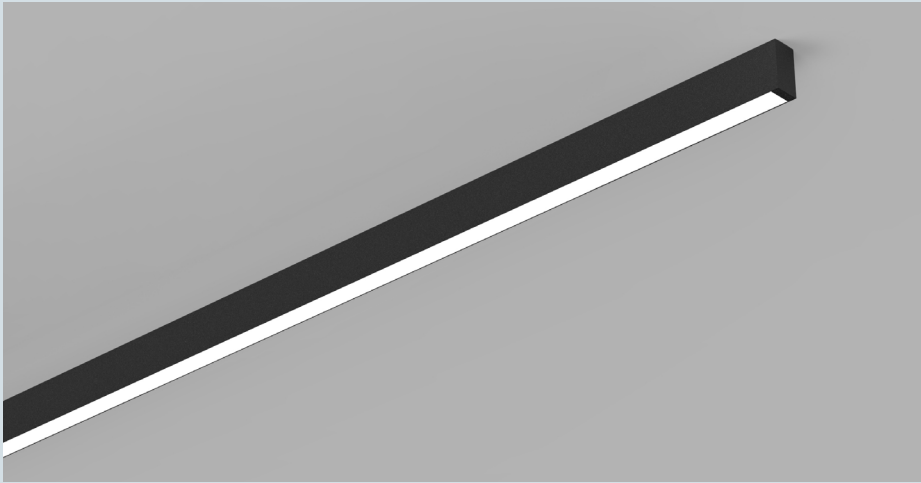

In combination with a white base plate, the white internal reflector creates a perfect mixing chamber. This creates a homogeneous light pattern without individually visible LED dots. All LED boards are protected from electrostatic discharge (ESD) and direct contact with the LED by a highly transparent acrylic glass.

ARCHITECTURAL | IDAHO 40

The surface-mounted profile system of the IDAHO family shows rooms in a distinctive setting. The elegant lines of light of Idaho 40 accentuate the architecture - mounted on ceilings, walls, corners or intersecting. Painted in one of 28 colors options, each project can be individually designed - to set accents or to create a mood for the interior. The luminaire is available with an LED-optimized opal diffuser for an even light distribution or a microprism to reduce glare and for greater visual comfort.

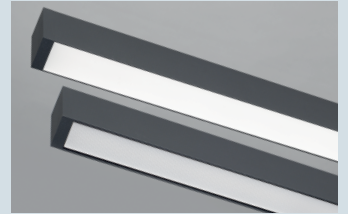
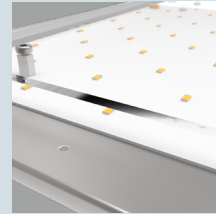

SYSTEM PROFILE

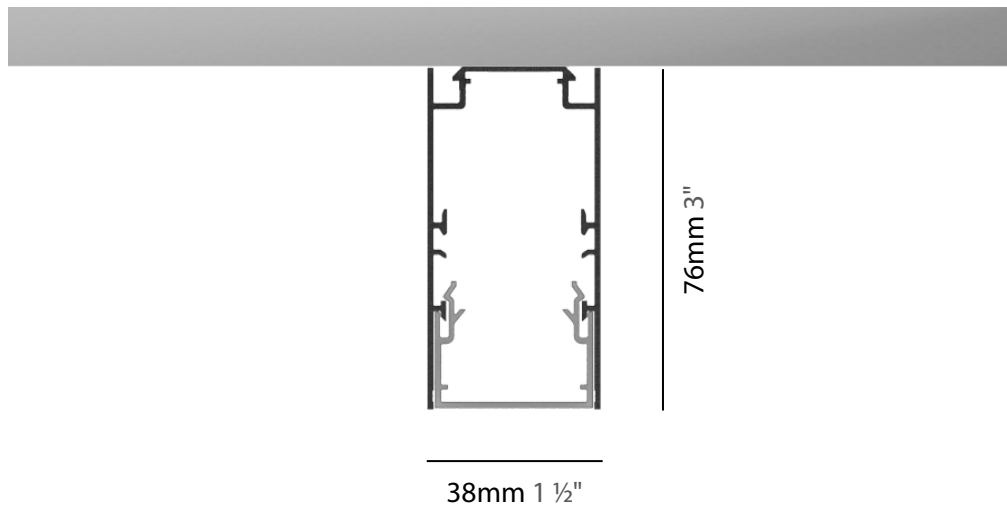

IDAHO 40 SURFACE SYSTEM SPECIFICATION SHEET

PROJECT _____
 TYPE _____
 NOTES _____
 QUANTITY _____
 DATE _____

SYSTEM GUIDE

To make your product selection and complete system specification, proceed with the following:
 review system options, create your system code in the field below and include your quantity.
 For the components, use the field beside each product name.
 Submit to quotes@zaneen.com to receive a formal BOM and finalized model numbers.

UPON REQUEST
 Additional Options _____
 _____ Color Temperature
 _____ RGB-W / Tunable
 _____ Lumen Output
 _____ Diffusers
 _____ CRI



EXAMPLE A3ID40-SUR-SYS-UNV-DN-27K-OP-S-01-01

SYSTEM BUILD CODE: A3ID40-SUR-SYS- qty

ELECTRICAL	Voltage	Dimming	Circuit				CCT - 90 CRI																						
	UNV - 120/277V	DN - Non Dim	EMCIR - Emergency Circuit				27K - 2700K																						
	120 - 120V	DP - Phase Dim (Triac/ELV)	MC - Multiple Circuits				30K - 3000K																						
	347 - 347V	DV - 0-10V (100-1%)				35K - 3500K																							
		DD - DALI (100-1%)				40K - 4000K																							
			<table border="1"> <thead> <tr> <th>Wattage</th> <th colspan="4">Delivered Lumen (lm)</th> </tr> <tr> <th>(W)</th> <th>2700K</th> <th>3000K</th> <th>3500K</th> <th>4000K</th> </tr> </thead> <tbody> <tr> <td>Per meter</td> <td>23.1</td> <td>2144</td> <td>2197</td> <td>2280</td> <td>2327</td> </tr> <tr> <td>Per foot</td> <td>7.1</td> <td>654</td> <td>670</td> <td>696</td> <td>710</td> </tr> </tbody> </table>				Wattage	Delivered Lumen (lm)				(W)	2700K	3000K	3500K	4000K	Per meter	23.1	2144	2197	2280	2327	Per foot	7.1	654	670	696	710	
Wattage	Delivered Lumen (lm)																												
(W)	2700K	3000K	3500K	4000K																									
Per meter	23.1	2144	2197	2280	2327																								
Per foot	7.1	654	670	696	710																								
			Approximate values																										

PHYSICAL	Distribution	Diffuser	Run Shapes*	Finish
	Direct	OP - Opal MP - Microprism	S _____' Straight L _____'x_____ ' Ceiling to Ceiling LV _____'x_____ ' Ceiling to Wall U _____'x_____ 'x_____ ' R _____'x_____ ' Rectangle T _____'x_____ ' X _____'x_____ '	Profile <input type="checkbox"/> _____ End Cap <input type="checkbox"/> _____ (28 colors) See page 4 for color options and use 2 digit numbers to indicate your choices

*The closest possible length will be provided based on the standard LED board lengths (705mm 27 3/4", 1128mm 44 7/16", 1408mm 55 7/16").

Opal and Microprism diffusers - The closest possible length will be provided based on the standard lengths (705mm 27 3/4", 1128mm 44 7/16", 1408mm 55 7/16", 2113mm 83 3/16", 2815mm 110 13/16" or per meter). Max length of a single run is 3000mm 118 1/8". Lengths are pre cut at the factory.

COMPONENTS	COVER BLACK	Length	qty
		A38892 - 1000mm 39 3/8" A38893 - 2000mm 78 3/4" A38894 - 3000mm 118 1/8"	

PROJECT	_____
TYPE	_____
NOTES	_____
QUANTITY	_____
DATE	_____

SYSTEM SUMMARY

System

Type

Surface
Rated for Dry Locations Ceiling and Wall Mounted

Approval Status

CSA Certified to CSA and UL Standards

Emission

Refer to emission icon beside each light insert and symbol legend for descriptions

Efficiency

Acrylic Opal Diffuser (snap-in) lens 43%
Micro-prismatic Diffuser (snap-in) lens 53%

Profile

Measurement

w 38mm (1 1/2") x ht. 76mm (3")

Housing

Anodized extruded aluminum profile available per meter and field-cuttable
Profiles have a maximum length of 3000mm (9' 10 1/4") and joined together with couplers to ensure uniform appearance and easy installation

Electrical

Connections

Luminaries are pre-wired with a factory installed branch circuit wiring and quick-release connectors.
Through wiring is used to connect the luminaries.

Power Feed

Located 2 inches from one end of the fixture, on top of the profile
If a different location is required, please specify
3 Wires - non-dimming or phase dimming
4 Wires - two circuits of non-dimming or phase dimming
5 Wires - 0-10V dimming or dali dimming

LED Driver

Integrated with inserts
Electronic Class 2 driver, Universal 120V/277V
Non-Dimming Driver, Phase Dimming Driver, and 0-10V Dimming Driver (10-100%)
Consult factory for driver cutsheet
If a different driver is required, please specify

Emergency Inverter Compatible

To be installed remotely, and provided by others
It can be located up to 250m away from the fixture

Emergency circuit wiring is available upon request (Isolated track with dedicated driver used for emergency circuit will connect to emergency battery pack - supplied by others)

General

Features

The multiple feed-ins at different points allow for lines of unlimited length. The optimized arrangement of the LED boards provides seamless connections without any dark spots.

In combination with a white base plate, the white internal reflector creates a perfect mixing chamber. This creates a homogeneous light pattern without individually visible LED dots.

All LED-Boards are protected from electrostatic discharge (ESD) and direct contact with the LED by a highly transparent acrylic glass.

End-caps, wall/ceiling, L, X, and T connectors can be specified with a different color option to the profile to create unique combinations

Custom Requests and Additional Options

Availability depends on insert, system, and configuration.
Must consult factory and allow up to 5 business days for an answer.

Color temperature, Special CRI, RGB-W, tunable, individual sizes, special diffuser, light inserts with different outputs, light inserts on different circuits.

Configuration

Consult factory for patterns or custom designs
Provide configuration drawings

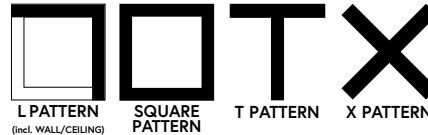

*Shop drawings provided upon receiving purchase order

Warranty

ZANEEN provides a limited warranty from date of purchase to original purchaser

LED Inserts: 5 year tested for 50,000 hours at 70% lumen output (L70)

LED Driver: 5 year

Non-Electrical Components: 1 year

*Check boxes to complete specification order and submit to quotes@zaneen.com to receive a formal BOM and a finalized model number

*In a constant effort to supply the best product, we reserve the right to change specifications or materials without notice. The most recent specification sheets are found at zaneen.com

PROJECT _____
 TYPE _____
 NOTES _____
 QUANTITY _____
 DATE _____

FINISH COLORS



Sparkling Silver - 01



Black Velvet - 02



Crystal White - 03

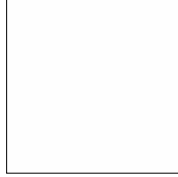

Creamy - 04



Hampton Bay - 05

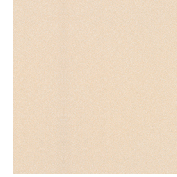

Urban Forest - 07



In the Army - 08

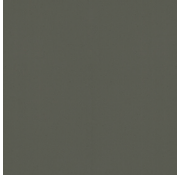

Rusty Angel - 09



Fade to Grey - 12



Mysterious Grey - 13



Lost Dream - 15



Purple Sky - 16



Fresh Oh - 17



Funky P - 18



Kissing Aphrodite - 19



Poseidon's Paradise - 20

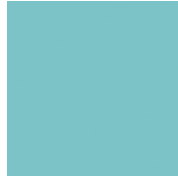

Blue Sky - 21



Spring Green - 22

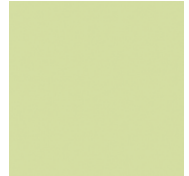

Mellow Yellow - 23



Golden Heart - 24



Gun Metal - 25



Champagne Cream - 26



Copper Mine - 27



Ancient Bronze - 28



Jazz Gold - 29



Olive Breeze - 30



Moonlight Silver - 31

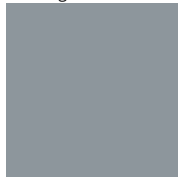

Rosewood Red - 32



Digital: Not all screens are calibrated the same, and therefore, colors will appear differently between screens.

Physical: When texture is involved, there will be variations in color, character and tone within a product series and between product families.





































































Gun Metal: No Gun Metal finish is alike. It combines a mixture of transparent and black color particles which ensures a highly individual effect and no luminaire being identical.

Champagne Cream, Copper Mine, Ancient Bronze + Jazz Gold: These finishes have slight fading from specific powder coating production. Each luminaire will slightly vary.









RAL Color Upon Request













LEGEND

	floor-mounted		pivotal		special LED (upon request) RGB, RGBW, tunable, gold+, meat+, art+, fashion+
	wall and ceiling: recessed and surface mounted		rotating		warm dim / natural dimming LED
	ceiling-mounted and wall-mounted		illuminate tilted		rechargeable battery powered
	wall-mounted		color of suspension cable		fixture with natural vivid LED (upon request)
	omni-directional light distribution		length of suspension cable		color rendering index
	direct light distribution		reflector degree selection		color temperature
	direct/indirect light distribution		super spot		lumen (luminous flux)
	indirect light distribution		lens		efficacy (lumens per watt)
	asymmetric light distribution		lens pack		Unified Glare Rating (UGR) range from 5-40
	aura light distribution		shine ring		marine grade (AISI 316 stainless steel)
	round wall or ceiling cut-out		integrated shine ring with diffuser		walk on
	square wall or ceiling cut-out		free individual colors 01-29		drive on
	the supplied jig specifies the cutout dimensions		individual colors: 00 (free of charge), 01-25 (extra charge)		Dark Sky Compliance
	minimum distance (meters) lamp - object		luminaire part to be colored (F1)		Americans with Disabilities Act (less than 4" off the wall located between 27"-84" from floor)
	recessed depth		luminaire part to be colored (F2)		lamp protected against explosion
	ceiling thickness in mm		luminaire part to be colored (F3)		blown glass using traditional methods by master glass blower
	ceiling thickness selection		luminaire part to be colored (F4)		acoustic material
	dimnable DP (phase), DV (0-10V), DD (dali), DS (step-dim)		luminaire part to be colored (F5)		protection class I, protection insulation
	included or excluded LED driver/transformer/control gear		color of 3-circuit adaptor		protection class II, protection insulation
	separately switchable		indirect diffuser		ETL Certified to UL and CSA Standards
	sensor		direct diffuser		UL Certified to UL and CSA Standards
	remote control		ball-proof (upon request)		CSA Certified to UL and CSA Standards
	available upon request		accessory		Certified for North American Standards

IP RATING

	protected against ingress of solid bodies greater than 12.5mm (finger)
	protected against ingress of solid bodies greater than 2.5mm protected against sprays of water up to 60 degrees from the vertical (rain)
	protected against ingress of solid bodies greater than 1mm (wire) no protection against the ingress of moisture
	protected against ingress of solid bodies greater than 1mm (wire) protected against water splashed from all directions
	protected against limited ingress of dust (wet rooms/covered outdoor areas) protected against water splashed from all directions
	protected against ingress of dust protected against jets of water
	protected against ingress of dust protected against powerful jets of water or heavy seas
	protected against ingress of dust protected against immersion of water between 15cm - 1m for 30 minutes
	protected against ingress of dust protected against immersion of water under pressure for long periods

IK RATING

	protected against 0.14 joules impact (equivalent to 0.25kg mass dropped from 56mm above the surface)
	protected against 0.2 joules impact (equivalent to 0.25kg mass dropped from 80mm above the surface)
	protected against 0.35 joules impact (equivalent to 0.25kg mass dropped from 140mm above the surface)
	protected against 0.5 joules impact (equivalent to 0.25kg mass dropped from 200mm above the surface)
	protected against 0.7 joules impact (equivalent to 0.25kg mass dropped from 280mm above the surface)
	protected against 1 joules impact (equivalent to 0.25kg mass dropped from 400mm above the surface)
	protected against 2 joules impact (equivalent to 0.5kg mass dropped from 400mm above the surface)
	protected against 5 joules impact (equivalent to 1.7kg mass dropped from 300mm above the surface)
	protected against 10 joules impact (equivalent to 5.0kg mass dropped from 200mm above the surface)
	protected against 20 joules impact (equivalent to 5.0kg mass dropped from 400mm above the surface)

PROJECT	_____
TYPE	_____
NOTES	_____
QUANTITY	_____
DATE	_____

WIRING DIAGRAMS

ALL ZANEEN FIXTURES ARE MANUFACTURED TO NORTH AMERICAN ELECTRICAL STANDARDS

Post Sales Support
HQ 1-800-388-3382 X 625 support@zaneen.com

IMPORTANT

- Do NOT connect directly to line voltage
- There is a minimum and maximum load per driver (See fixture and driver specifications).
- Fixture MUST be connected to LED driver, prior to turning power on

PHASE/NON-DIMMING WIRING DIAGRAM

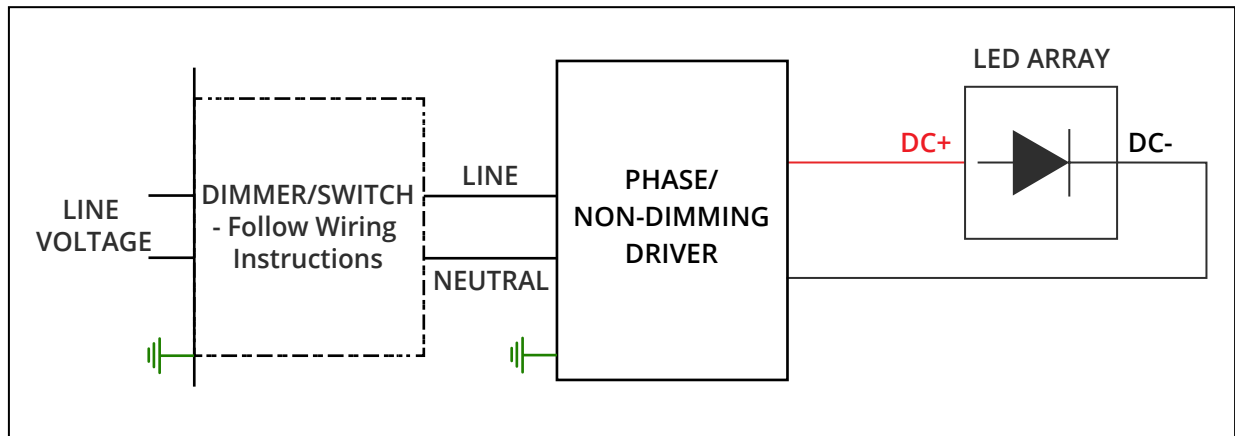

0-10V DIMMING WIRING DIAGRAM

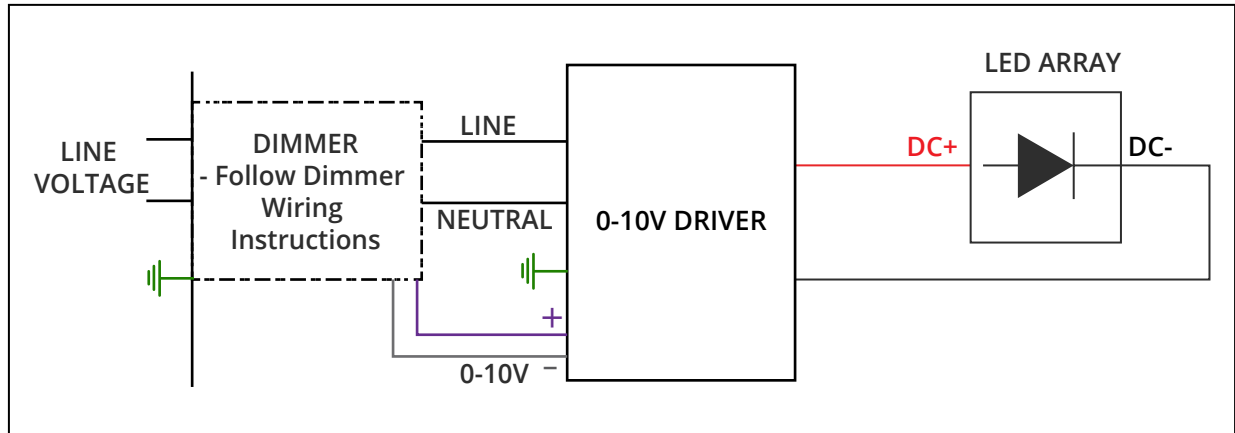

IDAHO 40 SURFACE SYSTEM SPECIFICATION SHEET

PROJECT	_____
TYPE	_____
NOTES	_____
QUANTITY	_____
DATE	_____

Insert custom drawing here or attach with additional pages

