

IDAHO 75 SURFACE SYSTEM SPECIFICATION SHEET

PROJECT	_____
TYPE	_____
NOTES	_____
QUANTITY	_____
DATE	_____

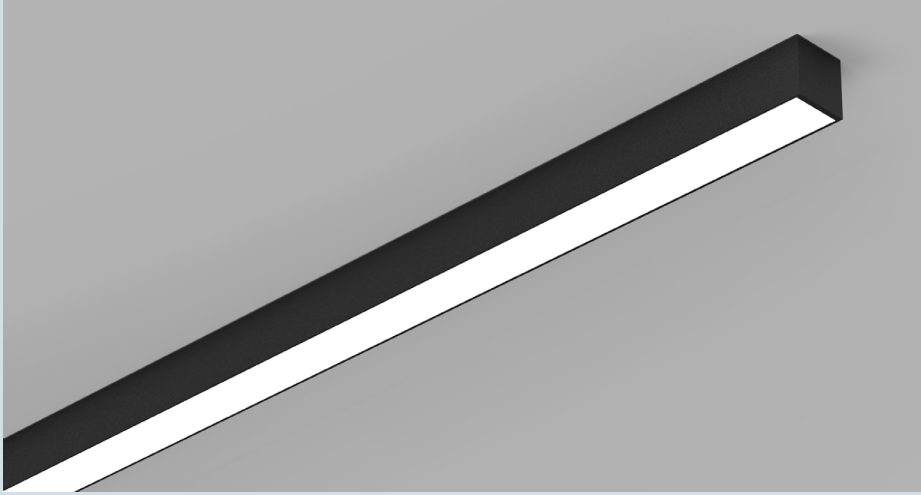

ARCHITECTURAL | IDAHO 75

The surface-mounted profile system of the IDAHO family shows rooms in a distinctive setting. The elegant lines of light of Idaho 75 can also run over corners. Painted in one of 28 colors options, each project can be individually designed - to set accents or to create a mood for the interior. The luminaire is available with an LED-optimized opal diffuser for an even light distribution or a microprism to reduce glare and for greater visual comfort.

In addition to the opal and prismatic diffusers, Invader downlights can be integrated into the profile. The single or double LED lighting modules offer a great visual comfort without altering the effect of the light if a colored cone is used. This enables zoning to be achieved without additional openings in the ceiling.

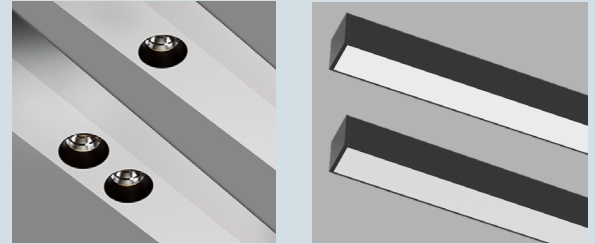

SYSTEM PROFILE

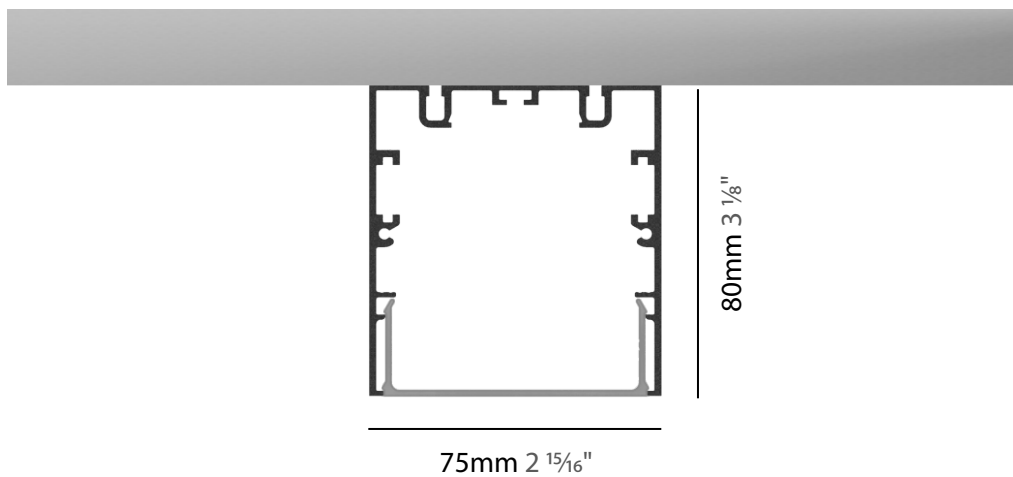

IDAHO 75 SURFACE SYSTEM SPECIFICATION SHEET

PROJECT _____
 TYPE _____
 NOTES _____
 QUANTITY _____
 DATE _____

SYSTEM GUIDE

To make your product selection and complete system specification, proceed with the following:
 review system options, create your system code in the field below and include your quantity.
 For the inserts/components, use the field beside each product name.
 Submit to quotes@zaneen.com to receive a formal BOM and finalized model numbers.

UPON REQUEST
 Additional Options _____
 _____ Color Temperature
 _____ RGB-W / Tunable
 _____ Lumen Output
 _____ Diffusers
 _____ CRI



EXAMPLE A3ID75-SUR-SYS-UNV-DN-30K-OP-S-01-01

SYSTEM BUILD CODE: A3ID75-SUR-SYS- qty

ELECTRICAL	Voltage	Dimming	Circuit		CCT - 90 CRI	
	UNV - 120/277V	DN - Non Dim	EMCIR - Emergency Circuit		30K - 3000K	
	120 - 120V	DP - Phase Dim (Triac/ELV)	MC - Multiple Circuits		35K - 3500K	
	347 - 347V	DV - 0-10V (100-1%)			40K - 4000K	
		DD - DALI (100-1%)				
		Wattage	Delivered Lumen (lm)			
		(W)	3000K	3500K	4000K	
Per meter		17.4	1551	1544	1576	
Per foot		5.3	473	471	481	

Approximate values

PHYSICAL	Distribution	Diffuser	Run Shapes*	Finish
	Direct	OP - Opal MP - Microprism	S _____' Straight L _____'x_____' U _____'x_____ 'x_____ ' R _____'x_____ ' Rectangle PAT - Custom Pattern 45°-180°Angle (Consult factory with drawings)	Profile <input type="checkbox"/> _____ End Cap <input type="checkbox"/> _____ (28 colors) See page 5 for color options and use 2 digit numbers to indicate your choices

*The closest possible length will be provided based on the standard LED board lengths (1140mm 44 7/8", 1420mm 55 7/8", 1700mm 66 15/16", 1980mm 77 15/16", 2270mm 89 3/8")

Opal and Microprism diffusers - Max length of a single run is 3000mm 118 1/8". Lengths are pre cut at the factory.

INSERTS	INSERT BUILD CODE EXAMPLE: A38627-DN-30K-01-20						
	INVADER	A38627-					qty
	Wattage: 9.8W	Dimming	CCT - 90 CRI	Finish	Reflector	Delivered Lumen (lm)	
		DN - Non Dim	30K - 3000K	<input type="checkbox"/> _____	20 - 20°	3000K 693	
		DP - Phase Dim	35K - 3500K	(28 colors)	40 - 40°	3500K 729	
	DV - 0-10V	40K - 4000K		60 - 60°	4000K 744		

IDAHO 75 SURFACE SYSTEM SPECIFICATION SHEET

PROJECT _____

TYPE _____

NOTES _____

QUANTITY _____

DATE _____

FINISHES OPTIONS:

See page 5 for color options and use 2 digit numbers to indicate your choices

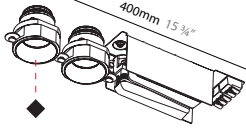
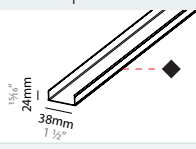
INSERTS	INVADER DOUBLE	A38630-					qty	
	Wattage: 19.6W	Dimming	CCT - 90 CRI	Finish	Reflector	Delivered Lumen (lm)		
	DN - Non Dim	30K - 3000K	◆ _____ (28 colors)	20 - 20°	3000K	1387		
	DP - Phase Dim	35K - 3500K		40 - 40°	3500K	1457		
	DV - 0-10V	40K - 4000K		60 - 60°	4000K	1487		
COMPONENTS	CAP PROFILE	A39458-					qty	
	per meter	Finish						
	◆ _____ (28 colors)							

Cap profile - Max length of a single run is 3000mm 118 1/8". Lengths are pre cut at the factory.

PROJECT	_____
TYPE	_____
NOTES	_____
QUANTITY	_____
DATE	_____

SYSTEM SUMMARY

System

Type

Surface
Rated for Dry Locations Ceiling and Wall Mounted

Approval Status

CSA Certified to CSA and UL Standards

Emission

Refer to emission icon beside each light insert and symbol legend for descriptions

Efficiency

Acrylic Opal Diffuser (snap-in) lens 43%
Micro-prismatic Diffuser (snap-in) lens 53%

Profile

Measurement

w 75mm (2 15/16") x ht. 80mm (3 1/8")

Housing

Anodized extruded aluminum profile available per meter and field-cuttable
Profiles have a maximum length of 3000mm (9' 10 15/16") and joined together with couplers to ensure uniform appearance and easy installation

Electrical

Connections

Luminaries are pre-wired with a factory installed branch circuit wiring and quick-release connectors.
Through wiring is used to connect the luminaries.

Power Feed

Located 2 inches from one end of the fixture, on top of the profile
If a different location is required, please specify
3 Wires - non-dimming or phase dimming
4 Wires - two circuits of non-dimming or phase dimming
5 Wires - 0-10V dimming or dali dimming

LED Driver

Integrated with inserts
Electronic Class 2 driver, Universal 120V/277V
Non-Dimming Driver, Phase Dimming Driver, and 0-10V Dimming Driver (10-100%)
Consult factory for driver cutsheet
If a different driver is required, please specify

Emergency Inverter Compatible

To be installed remotely, and provided by others
It can be located up to 250m away from the fixture

Emergency circuit wiring is available upon request (Isolated track with dedicated driver used for emergency circuit will connect to emergency battery pack - supplied by others)

General

Features

The multiple feed-ins at different points allow for lines of unlimited length. The optimized arrangement of the LED boards provides seamless connections without any dark spots.

In addition to the opal and prismatic diffusers, powerful downlights partially with KORONA CONE can be integrated into the profile. This enables zoning to be achieved without additional openings in the ceiling.

All LED-Boards are protected from electrostatic discharge (ESD) and direct contact with the LED by a highly transparent acrylic glass.

End-caps and cap profile can be specified with a different color option to the profile to create unique combinations.

Custom Requests and Additional Options

Availability depends on insert, system, and configuration
Must consult factory and allow up to 5 business days for an answer

Color temperature, Special CRI, RGB-W, tunable, individual sizes, special diffuser, light inserts with different outputs, light inserts on different circuits, miter cuts

Invader spot integrated into opal diffuser available; depending on size and length

Configuration

Consult factory for patterns or custom designs
Provide configuration drawings

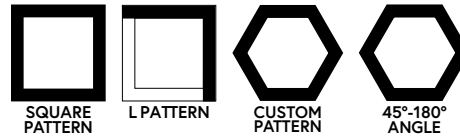

*Shop drawings provided upon receiving purchase order

Warranty

ZANEEN provides a limited warranty from date of purchase to original purchaser

LED Inserts: 5 year tested for 50,000 hours at 70% lumen output (L70)

LED Driver: 5 year

Non-Electrical Components: 1 year

*Check boxes to complete specification order and submit to quotes@zaneen.com to receive a formal BOM and a finalized model number

*In a constant effort to supply the best product, we reserve the right to change specifications or materials without notice. The most recent specification sheets are found at zaneen.com

PROJECT _____
 TYPE _____
 NOTES _____
 QUANTITY _____
 DATE _____

FINISH COLORS



Sparkling Silver - 01



Black Velvet - 02



Crystal White - 03

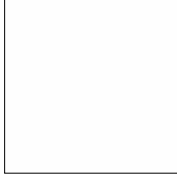

Creamy - 04



Hampton Bay - 05



Urban Forest - 07



In the Army - 08



Rusty Angel - 09



Fade to Grey - 12



Mysterious Grey - 13



Lost Dream - 15

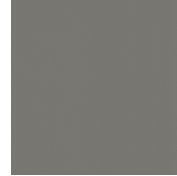

Purple Sky - 16



Fresh Oh - 17



Funky P - 18



Kissing Aphrodite - 19



Poseidon's Paradise - 20



Blue Sky - 21



Spring Green - 22



Mellow Yellow - 23

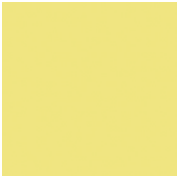

Golden Heart - 24



Gun Metal - 25



Champagne Cream - 26



Copper Mine - 27



Ancient Bronze - 28



Jazz Gold - 29



Olive Breeze - 30



Moonlight Silver - 31



Rosewood Red - 32



Digital: Not all screens are calibrated the same, and therefore, colors will appear differently between screens.

Physical: When texture is involved, there will be variations in color, character and tone within a product series and between product families.





































































Gun Metal: No Gun Metal finish is alike. It combines a mixture of transparent and black color particles which ensures a highly individual effect and no luminaire being identical.

Champagne Cream, Copper Mine, Ancient Bronze + Jazz Gold: These finishes have slight fading from specific powder coating production. Each luminaire will slightly vary.











RAL Color Upon Request













LEGEND

	floor-mounted		pivotal		special LED (upon request) RGB, RGBW, tunable, gold+, meat+, art+, fashion+
	wall and ceiling: recessed and surface mounted		rotating		warm dim / natural dimming LED
	ceiling-mounted and wall-mounted		illuminate tilted		rechargeable battery powered
	wall-mounted		color of suspension cable		fixture with natural vivid LED (upon request)
	omni-directional light distribution		length of suspension cable		color rendering index
	direct light distribution		reflector degree selection		color temperature
	direct/indirect light distribution		super spot		lumen (luminous flux)
	indirect light distribution		lens		efficacy (lumens per watt)
	asymmetric light distribution		lens pack		Unified Glare Rating (UGR) range from 5-40
	aura light distribution		shine ring		marine grade (AISI 316 stainless steel)
	round wall or ceiling cut-out		integrated shine ring with diffuser		walk on
	square wall or ceiling cut-out		free individual colors 01-29		drive on
	the supplied jig specifies the cutout dimensions		individual colors: 00 (free of charge), 01-25 (extra charge)		Dark Sky Compliance
	minimum distance (meters) lamp - object		luminaire part to be colored (F1)		Americans with Disabilities Act (less than 4" off the wall located between 27"-84" from floor)
	recessed depth		luminaire part to be colored (F2)		lamp protected against explosion
	ceiling thickness in mm		luminaire part to be colored (F3)		blown glass using traditional methods by master glass blower
	ceiling thickness selection		luminaire part to be colored (F4)		acoustic material
	dimnable DP (phase), DV (0-10V), DD (dali), DS (step-dim)		luminaire part to be colored (F5)		protection class I, protection insulation
	included or excluded LED driver/transformer/control gear		color of 3-circuit adaptor		protection class II, protection insulation
	separately switchable		indirect diffuser		ETL Certified to UL and CSA Standards
	sensor		direct diffuser		UL Certified to UL and CSA Standards
	remote control		ball-proof (upon request)		CSA Certified to UL and CSA Standards
	available upon request		accessory		Certified for North American Standards

IP RATING

	protected against ingress of solid bodies greater than 12.5mm (finger)
	protected against ingress of solid bodies greater than 2.5mm protected against sprays of water up to 60 degrees from the vertical (rain)
	protected against ingress of solid bodies greater than 1mm (wire) no protection against the ingress of moisture
	protected against ingress of solid bodies greater than 1mm (wire) protected against sprays of water up to 60 degrees from the vertical (rain)
	protected against ingress of solid bodies greater than 1mm (wire) protected against water splashed from all directions
	protected against limited ingress of dust (wet rooms/covered outdoor areas) protected against water splashed from all directions
	protected against ingress of dust protected against jets of water
	protected against ingress of dust protected against powerful jets of water or heavy seas
	protected against ingress of dust protected against immersion of water between 15cm - 1m for 30 minutes
	protected against ingress of dust protected against immersion of water under pressure for long periods

IK RATING

	protected against 0.14 joules impact (equivalent to 0.25kg mass dropped from 56mm above the surface)
	protected against 0.2 joules impact (equivalent to 0.25kg mass dropped from 80mm above the surface)
	protected against 0.35 joules impact (equivalent to 0.25kg mass dropped from 140mm above the surface)
	protected against 0.5 joules impact (equivalent to 0.25kg mass dropped from 200mm above the surface)
	protected against 0.7 joules impact (equivalent to 0.25kg mass dropped from 280mm above the surface)
	protected against 1 joules impact (equivalent to 0.25kg mass dropped from 400mm above the surface)
	protected against 2 joules impact (equivalent to 0.5kg mass dropped from 400mm above the surface)
	protected against 5 joules impact (equivalent to 1.7kg mass dropped from 300mm above the surface)
	protected against 10 joules impact (equivalent to 5.0kg mass dropped from 200mm above the surface)
	protected against 20 joules impact (equivalent to 5.0kg mass dropped from 400mm above the surface)

PROJECT	_____
TYPE	_____
NOTES	_____
QUANTITY	_____
DATE	_____

WIRING DIAGRAMS

ALL ZANEEN FIXTURES ARE MANUFACTURED TO NORTH AMERICAN ELECTRICAL STANDARDS

Post Sales Support
HQ 1-800-388-3382 X 625 support@zaneen.com

IMPORTANT

- Do NOT connect directly to line voltage
- There is a minimum and maximum load per driver (See fixture and driver specifications).
- Fixture MUST be connected to LED driver, prior to turning power on

PHASE/NON-DIMMING WIRING DIAGRAM

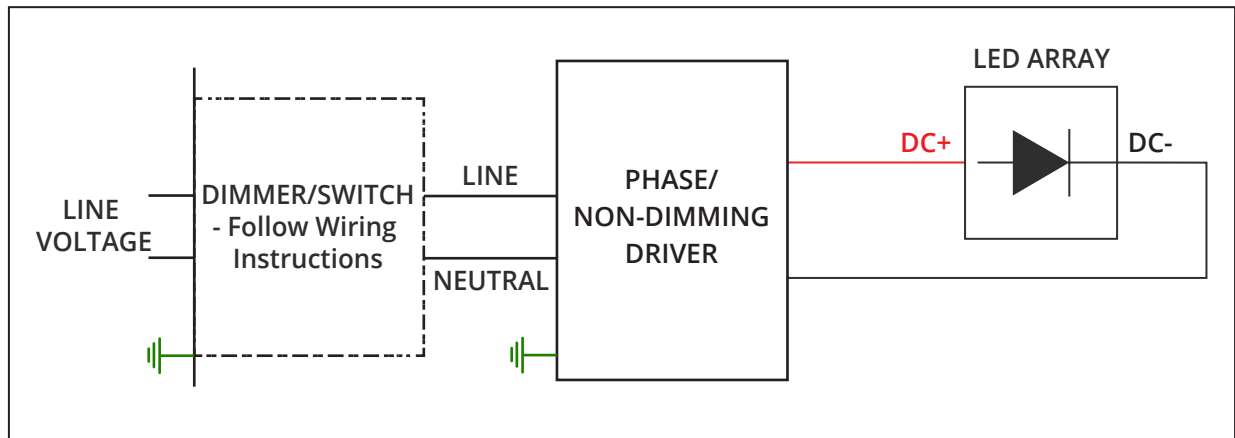

0-10V DIMMING WIRING DIAGRAM

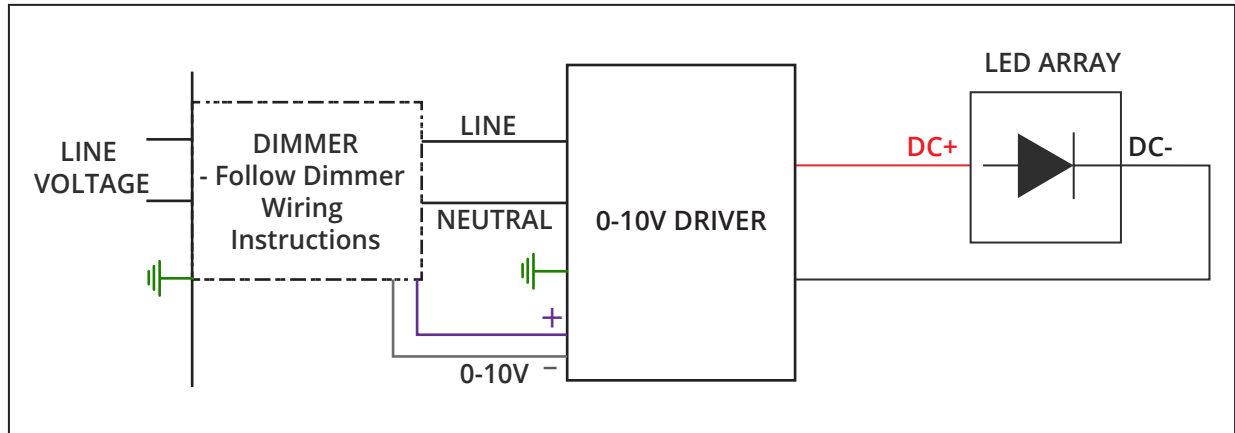

IDAHO 75 SURFACE SYSTEM SPECIFICATION SHEET

PROJECT	_____
TYPE	_____
NOTES	_____
QUANTITY	_____
DATE	_____

Insert custom drawing here or attach with additional pages

