

## INFINITE HORIZON RECESSED/SURFACE SYSTEM SPECIFICATION SHEET

PROJECT	_____
TYPE	_____
NOTES	_____
QUANTITY	_____
DATE	_____



### ARCHITECTURAL | INFINITE HORIZON

INFINITE HORIZON makes light shine through. Suitable for back-lighting of transparent or translucent materials: glass, marble, onyx, surfaces with graphics etc... The absence of the opal diffuser maximizes the output light, keeping in sight the characteristic "dotted" effect of the laser marking. Elegance and simplicity make the backlit a timeless product, the protagonist of the scene and unforgettable.



### SYSTEM PROFILE

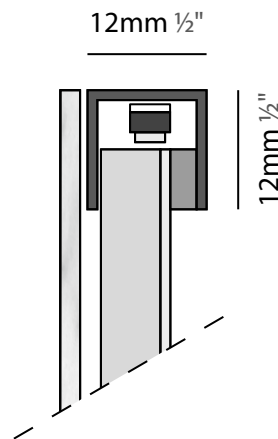

## INFINITE HORIZON RECESSED/SURFACE SYSTEM SPECIFICATION SHEET

PROJECT \_\_\_\_\_  
 TYPE \_\_\_\_\_  
 NOTES \_\_\_\_\_  
 QUANTITY \_\_\_\_\_  
 DATE \_\_\_\_\_

### SYSTEM GUIDE

To make your product selection and complete system specification, proceed with the following: review system options, create your system code in the field below and include your quantity. Submit to quotes@zaneen.com to receive a formal BOM and finalized model numbers.

UPON REQUEST  
 Additional Options \_\_\_\_\_  
 Color Temperature \_\_\_\_\_  
 Tunable White \_\_\_\_\_  
 LED Colors \_\_\_\_\_  
 Wattage per foot/meter \_\_\_\_\_  
 RGB \_\_\_\_\_



EXAMPLE A5INHO-MOD-SYS-UNV-DN-27K-REC-mm-1S-ALU

**SYSTEM BUILD CODE: A5INHO-MOD-SYS-** **qty**

<b>ELECTRICAL</b>	Voltage	Dimming	Circuit	CCT - 90 CRI	
	<b>UNV</b> - 120/277V	<b>DN</b> - Non Dim	<b>EMCIR</b> - Emergency Circuit	<b>27K</b> - 2700K	<b>57K</b> - 5700K
	<b>120</b> - 120V	<b>DV</b> - 0-10V (100-1%)		<b>30K</b> - 3000K	
<b>347</b> - 347V	<b>DD</b> - DALI (100-1%)	<b>35K</b> - 3500K			
		<b>DP</b> - Phase Dim (Triac/ELV) (Upon Request)		<b>40K</b> - 4000K	
	Wattage	Delivered Lumen (lm)			
<b>Per meter</b>	20	to be confirmed at time of quotation			
<b>Per foot</b>	6				

<b>PHYSICAL</b>	Mounting Type	Dimensions	Led Positioning	Finishes
	<b>REC</b> - Recessed	Specify in mm (A) _____ X (B) _____	<b>1S</b> - 1 Led Side**  Long side (A) **(B) max 300mm	Panel frame  (4 colors)
	<b>SUR</b> - Surface	Specify in X'-X" (A) _____ X (B) _____	<b>2S</b> - 2 Led Sides  Long sides (A)	See page 4 for color options and use 3 digit letters to indicate your choices
	See Minimum and Maximum Dimensions below.	<b>4S</b> - 4 Led Sides  Equivalent sides (A=B)		

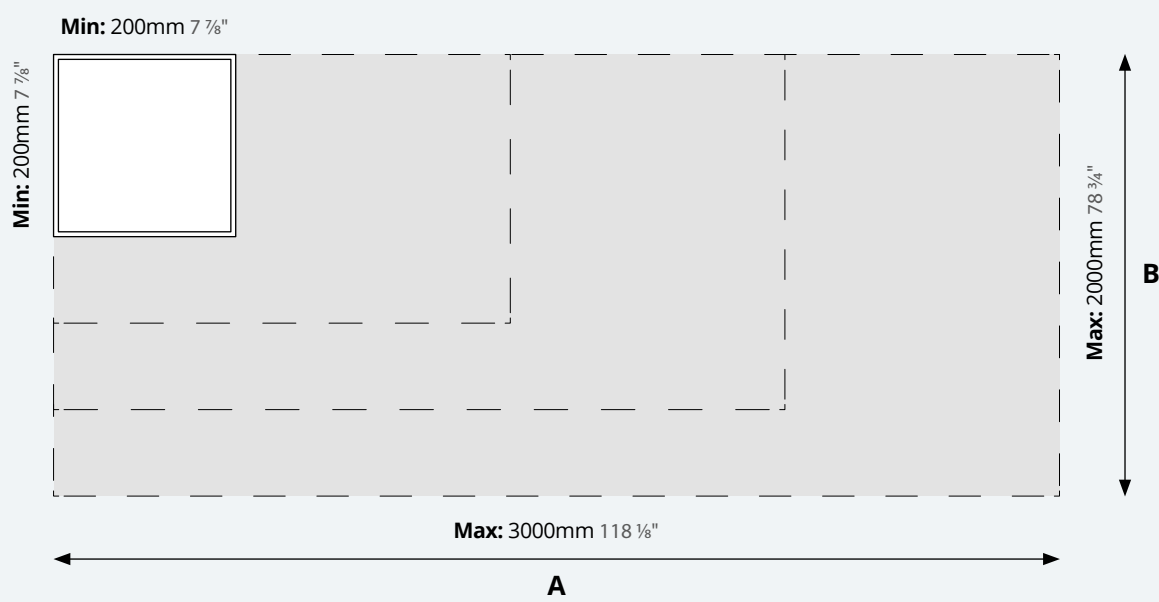

PROJECT	_____
TYPE	_____
NOTES	_____
QUANTITY	_____
DATE	_____

### SYSTEM SUMMARY

#### System

**Type**  
Surface  
Rated for Dry Locations Ceiling and Wall Mounted

**Approval Status**  
CSA Certified to CSA and UL Standards

**Emission**  
Refer to emission icon beside each light insert and symbol legend for descriptions

#### Profile

**Measurement**  
max. 3000mm (118 1/8") x max. 2000mm (78 3/4") x w 12mm (1/2")

**Housing**  
Aluminum profile built to desired size with laser cut diffuser. Approximate increments of 200mm (7 7/8")  
Profiles have a maximum length of 3000mm (9' 10 15/16")

#### Electrical

**Connections**  
Luminaries are pre-wired by factory and provided with quick release connectors to join multiple profiles

**Power Feed**  
The exit cable's hole standard position, unless otherwise specified, is located on the Panel's left low back.  
The power cable's section may change according to the panel's dimension, mounting system and customer request (our technical department will check the absence of voltage drops). The power cables' number may change according to the panel's dimension.

All the LED Panels with >2000 mm size are powered on both ends (end to end) or, upon request close proximity to the profile center, in order to guarantee proper light uniformity.

**LED Driver**  
Driver must be remote with supplied enclosure. Maximum distance between the power supply and the last fixture on the circuit is 30' using a 18-gauge wire. For more than 30', the gauge of the wire must be determined by a certified professional.

Electronic Class 2 driver, Universal 120V/277V Non Dimming Driver, Dimming Driver 0-10V (10-100%) Consult factory for driver cutsheet If a different driver is required, please specify.

**Emergency Inverter Compatible**  
To be installed remotely, and provided by others  
It can be located up to 250m away from the fixture

Emergency circuit wiring is available upon request (Isolated track with dedicated driver used for emergency circuit will connect to emergency battery pack - supplied by others)

#### General

**Features**  
Infinite Horizon makes light shine through. Suitable for back-lighting of transparent or translucent materials: glass, marble, onyx, surfaces with graphics etc... The absence of the opal diffuser maximizes the output light, keeping in sight the characteristic "dotted" effect of the laser marking. Elegance and simplicity make the backlit a timeless product, the protagonist of the scene and unforgettable.

**Custom Requests and Additional Options**  
Color temperature, tunable white, LED colors, Wattage per foot/meter, RGB.

Must consult factory and allow up to 5 business days for an answer.

**Configuration**  
Consult factory for patterns or custom designs  
Provide configuration drawings

\*Shop drawings provided upon receiving purchase order

#### Warranty

ZANEEN provides a limited warranty from date of purchase to original purchaser

**LED Inserts:** 5 year tested for 50,000 hours at 70% lumen output (L70)  
**LED Driver:** 5 year  
**Non-Electrical Components:** 1 year

\*Check boxes to complete specification order and submit to quotes@zaneen.com to receive a formal BOM and a finalized model number

\*In a constant effort to supply the best product, we reserve the right to change specifications or materials without notice. The most recent specification sheets are found at zaneen.com

## INFINITE HORIZON RECESSED/SURFACE SYSTEM SPECIFICATION SHEET

PROJECT \_\_\_\_\_  
TYPE \_\_\_\_\_  
NOTES \_\_\_\_\_  
QUANTITY \_\_\_\_\_  
DATE \_\_\_\_\_

### FINISH COLORS



Aluminum - **ALU**

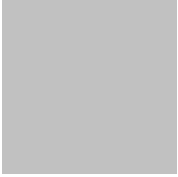

Black - **BLK**

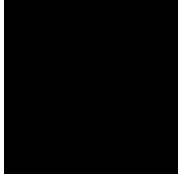

Gold - **GLD**







































































White - **WHI**













## INFINITE HORIZON RECESSED/SURFACE SYSTEM SPECIFICATION SHEET











### LEGEND

	floor-mounted		pivotal		special LED (upon request) RGB, RGBW, tunable, gold+, meat+, art+, fashion+
	wall and ceiling: recessed and surface mounted		rotating		warm dim / natural dimming LED
	ceiling-mounted and wall-mounted		illuminate tilted		rechargeable battery powered
	wall-mounted		color of suspension cable		fixture with natural vivid LED (upon request)
	omni-directional light distribution		length of suspension cable		color rendering index
	direct light distribution		reflector degree selection		color temperature
	direct/indirect light distribution		super spot		lumen (luminous flux)
	indirect light distribution		lens		efficacy (lumens per watt)
	asymmetric light distribution		lens pack		Unified Glare Rating (UGR) range from 5-40
	aura light distribution		shine ring		marine grade (AISI 316 stainless steel)
	round wall or ceiling cut-out		integrated shine ring with diffuser		walk on
	square wall or ceiling cut-out		free individual colors 01-29		drive on
	the supplied jig specifies the cutout dimensions		individual colors: 00 (free of charge), 01-25 (extra charge)		Dark Sky Compliance
	minimum distance (meters) lamp - object		luminaire part to be colored (F1)		Americans with Disabilities Act (less than 4" off the wall located between 27"-84" from floor)
	recessed depth		luminaire part to be colored (F2)		lamp protected against explosion
	ceiling thickness in mm		luminaire part to be colored (F3)		blown glass using traditional methods by master glass blower
	ceiling thickness selection		luminaire part to be colored (F4)		acoustic material
	dimmable DP (phase), DV (0-10V), DD (dali), DS (step-dim)		luminaire part to be colored (F5)		protection class I, protection insulation
	included or excluded LED driver/transformer/control gear		color of 3-circuit adaptor		protection class II, protection insulation
	separately switchable		indirect diffuser		ETL Certified to UL and CSA Standards
	sensor		direct diffuser		UL Certified to UL and CSA Standards
	remote control		ball-proof (upon request)		CSA Certified to UL and CSA Standards
	available upon request		accessory		Certified for North American Standards

### IP RATING

	protected against ingress of solid bodies greater than 12.5mm (finger)
	protected against ingress of solid bodies greater than 2.5mm protected against sprays of water up to 60 degrees from the vertical (rain)
	protected against ingress of solid bodies greater than 1mm (wire) no protection against the ingress of moisture
	protected against ingress of solid bodies greater than 1mm (wire) protected against sprays of water up to 60 degrees from the vertical (rain)
	protected against ingress of solid bodies greater than 1mm (wire) protected against water splashed from all directions
	protected against limited ingress of dust (wet rooms/covered outdoor areas) protected against water splashed from all directions
	protected against ingress of dust protected against jets of water
	protected against ingress of dust protected against powerful jets of water or heavy seas
	protected against ingress of dust protected against immersion of water between 15cm - 1m for 30 minutes
	protected against ingress of dust protected against immersion of water under pressure for long periods

### IK RATING

	protected against 0.14 joules impact (equivalent to 0.25kg mass dropped from 56mm above the surface)
	protected against 0.2 joules impact (equivalent to 0.25kg mass dropped from 80mm above the surface)
	protected against 0.35 joules impact (equivalent to 0.25kg mass dropped from 140mm above the surface)
	protected against 0.5 joules impact (equivalent to 0.25kg mass dropped from 200mm above the surface)
	protected against 0.7 joules impact (equivalent to 0.25kg mass dropped from 280mm above the surface)
	protected against 1 joules impact (equivalent to 0.25kg mass dropped from 400mm above the surface)
	protected against 2 joules impact (equivalent to 0.5kg mass dropped from 400mm above the surface)
	protected against 5 joules impact (equivalent to 1.7kg mass dropped from 300mm above the surface)
	protected against 10 joules impact (equivalent to 5.0kg mass dropped from 200mm above the surface)
	protected against 20 joules impact (equivalent to 5.0kg mass dropped from 400mm above the surface)

## INFINITE HORIZON RECESSED/SURFACE SYSTEM SPECIFICATION SHEET

### WIRING DIAGRAMS

ALL ZANEEN FIXTURES ARE MANUFACTURED TO NORTH AMERICAN ELECTRICAL STANDARDS

Post Sales Support  
 HQ 1-800-388-3382 X 625 support@zaneen.com

#### IMPORTANT

- Do NOT connect directly to line voltage
- There is a minimum and maximum load per driver (See fixture and driver specifications).
- Fixture MUST be connected to LED driver, prior to turning power on

#### PHASE/NON-DIMMING WIRING DIAGRAM

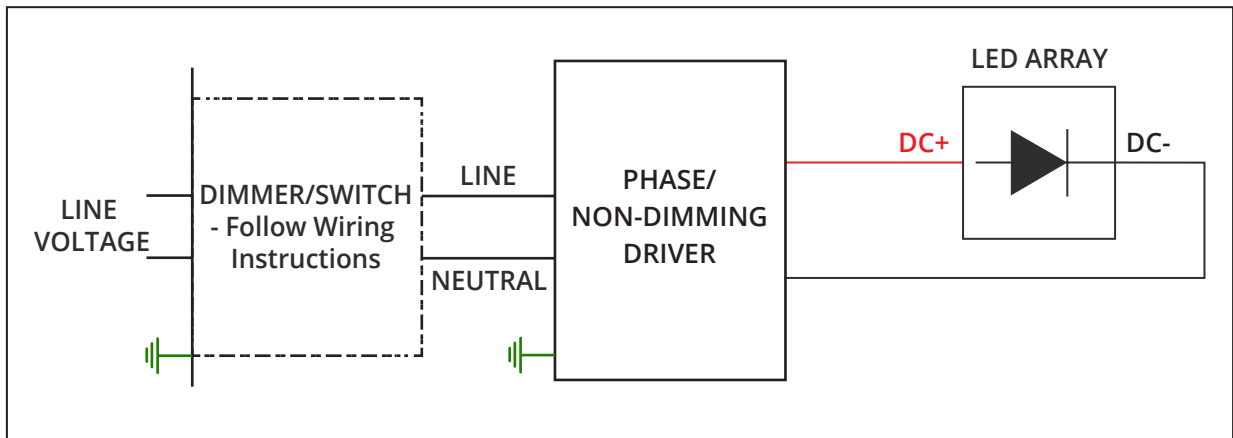

#### 0-10V DIMMING WIRING DIAGRAM

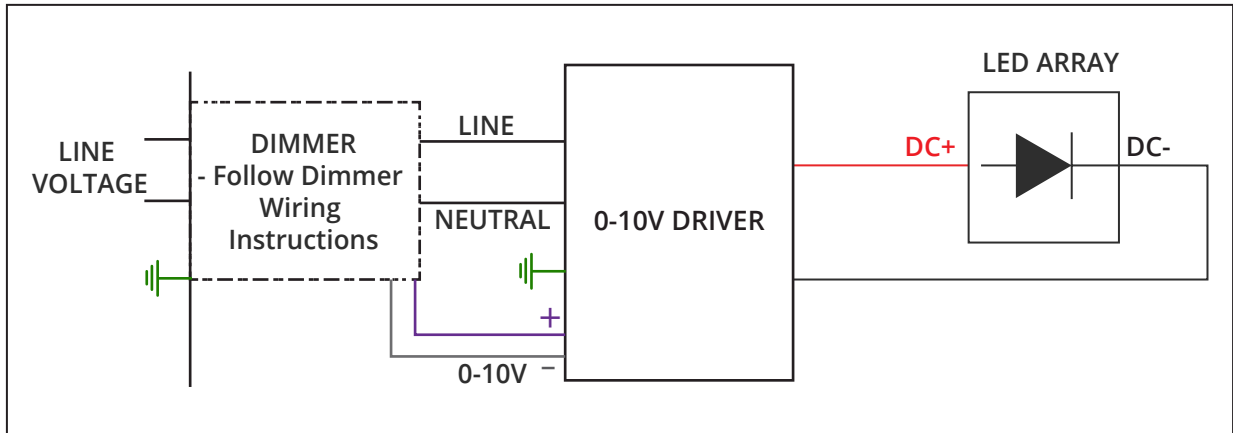

## INFINITE HORIZON RECESSED/SURFACE SYSTEM SPECIFICATION SHEET

PROJECT	_____
TYPE	_____
NOTES	_____
QUANTITY	_____
DATE	_____

Insert custom drawing here or attach with additional pages

