

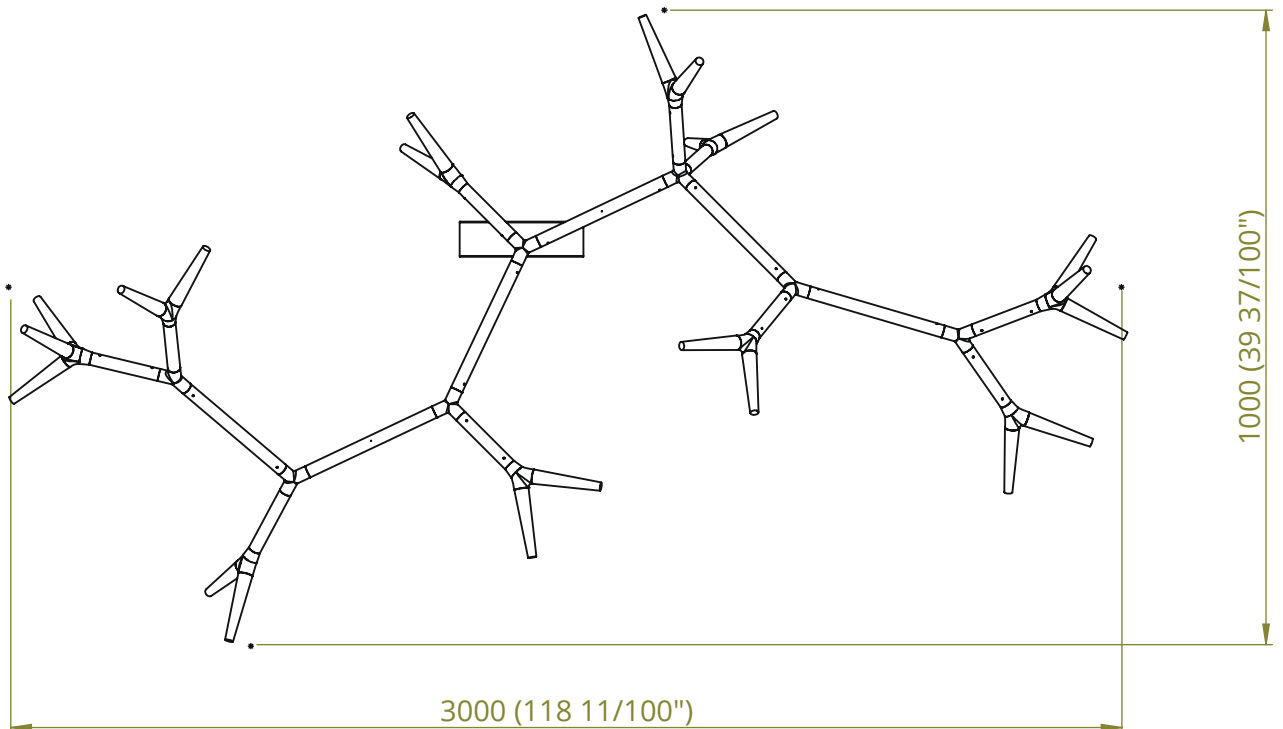

IP 20

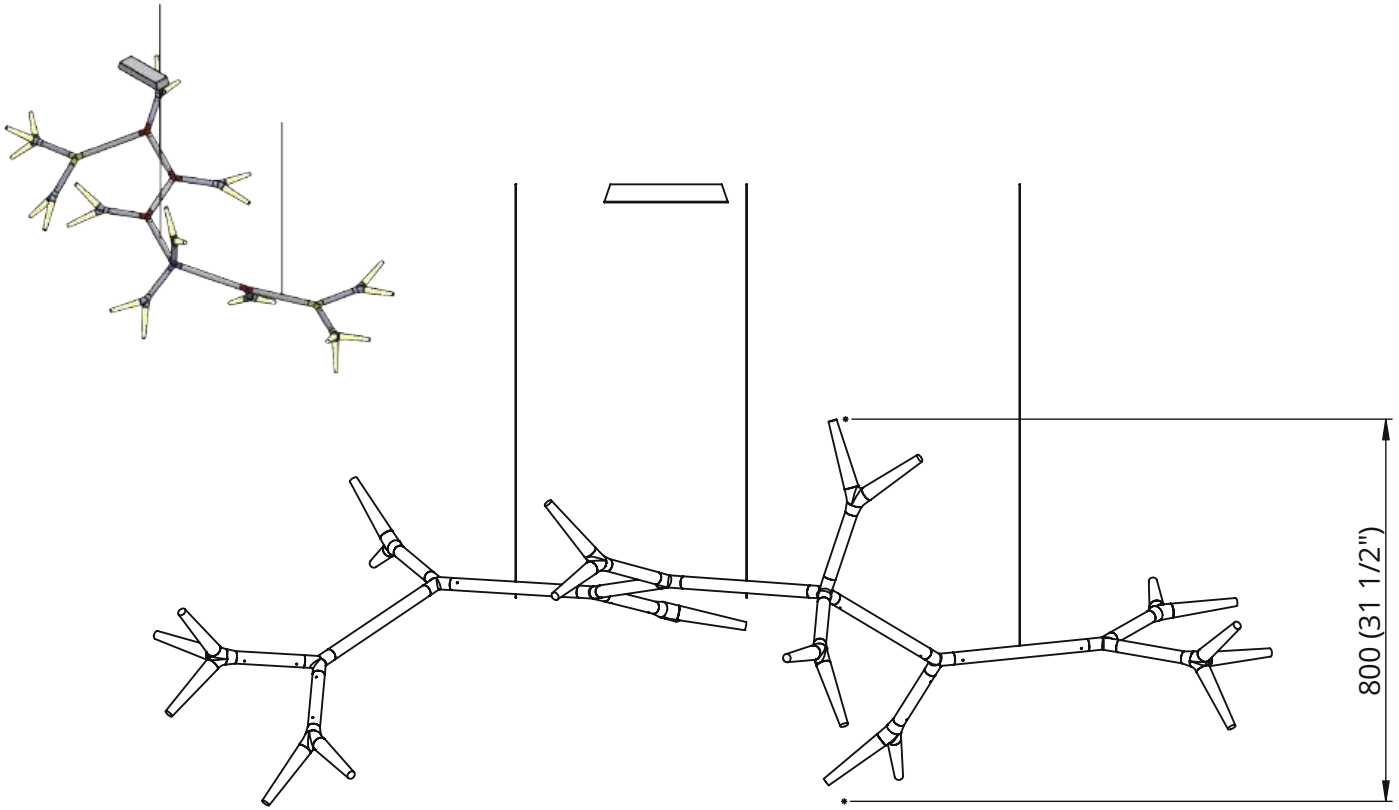



1

SAFETY INFORMATION

- During installation, maintenance work and change of illuminants, always interrupt the power supply by removing the respective circuit breaker.
- When switched on, the lamp may cause burns when touched.
- Luminaire must not be mounted on conductive materials supply when changing lamps.

TECHNICAL DATA

- Input Voltage 120VAC
- Output Voltage 24VDC
- Safety Class I
- Degree of protection IP20
- Lamp must not be used outdoors.
- Minimum distance from illuminated surface 0.5m

TOOLS



3.1

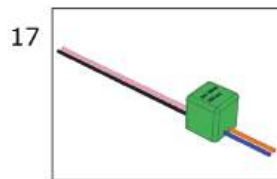
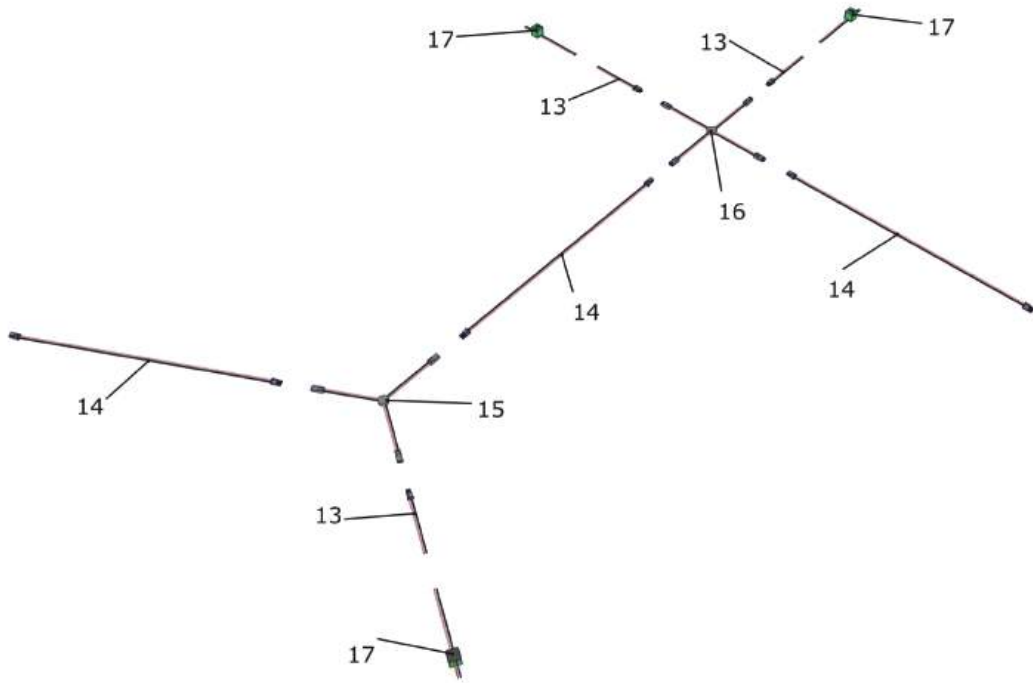

3.2

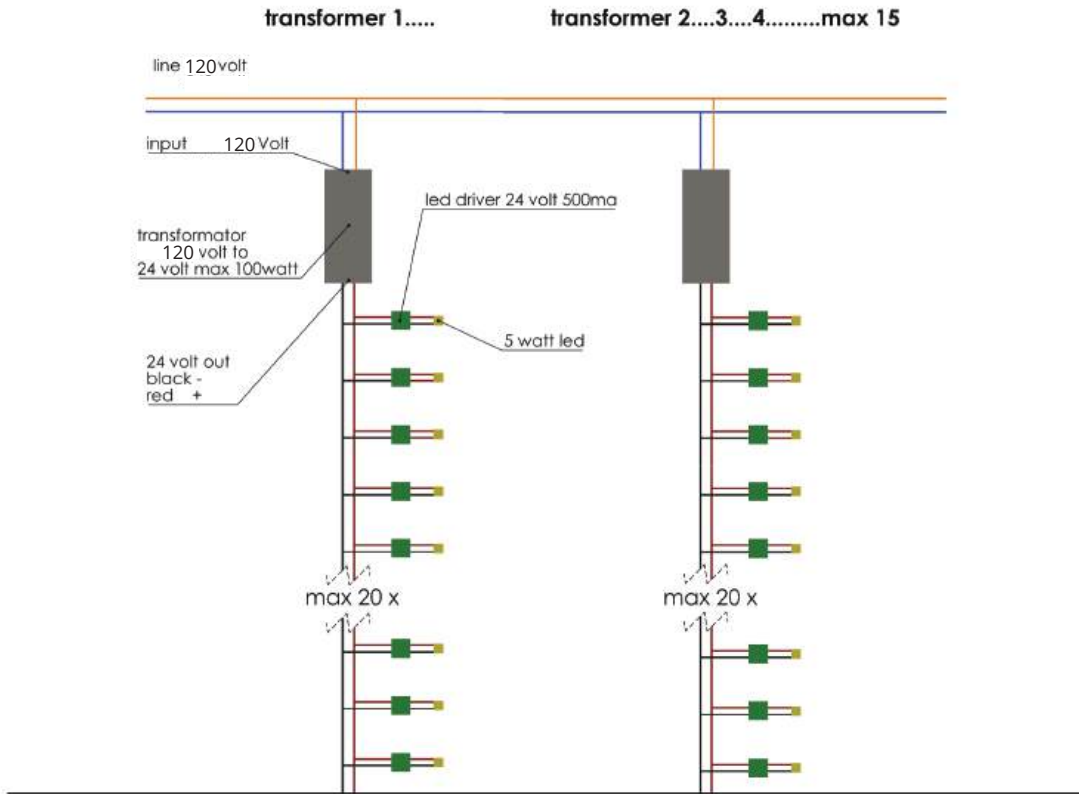

4.1

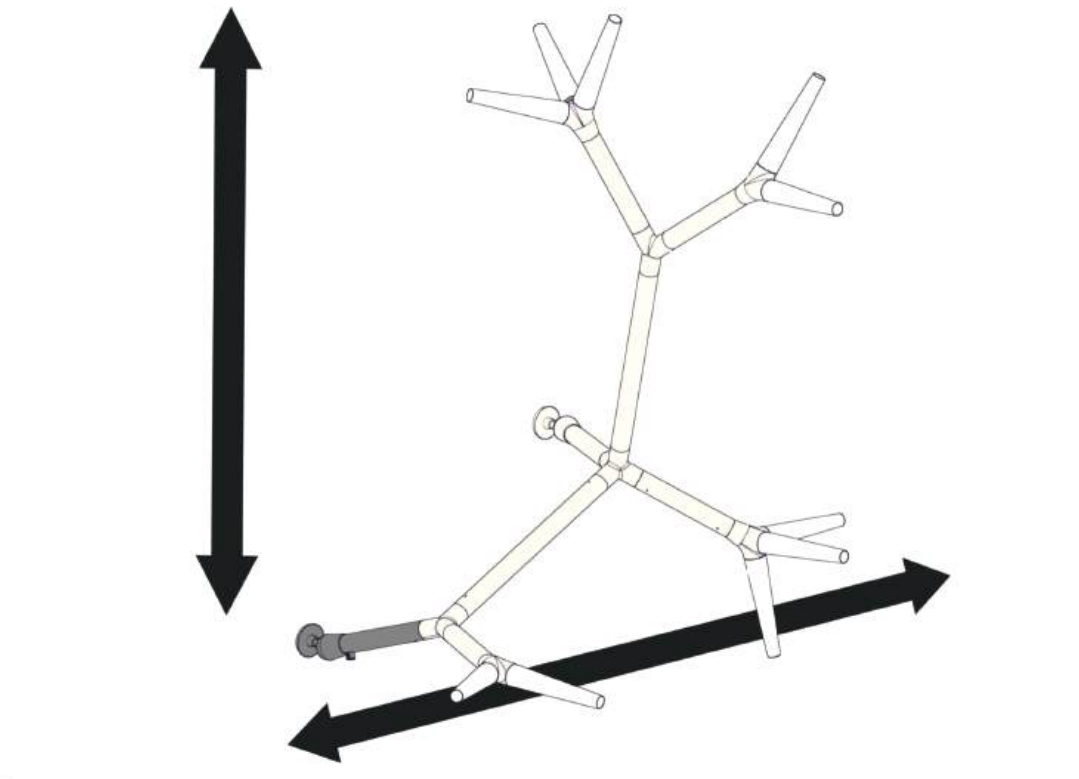

4.2

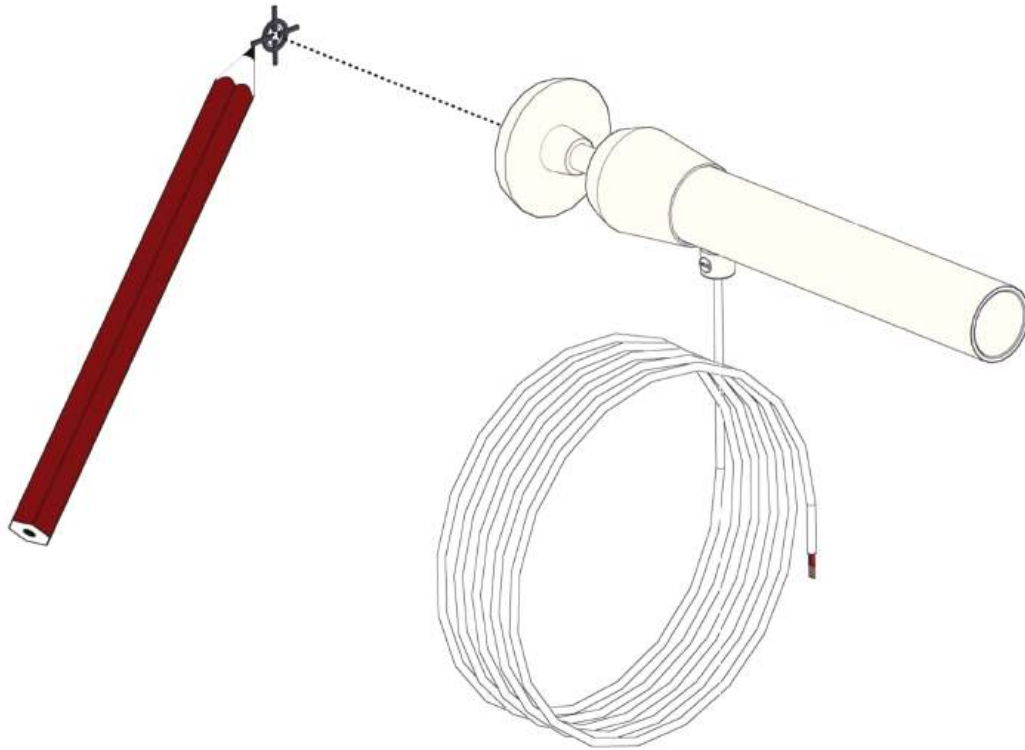

4.3

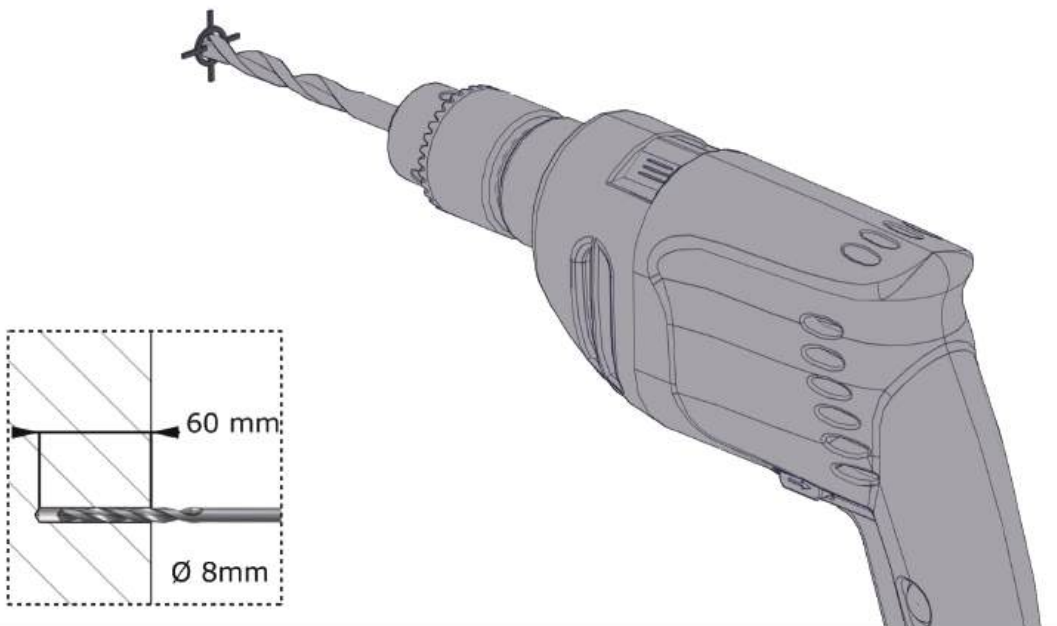

4.4



4.5

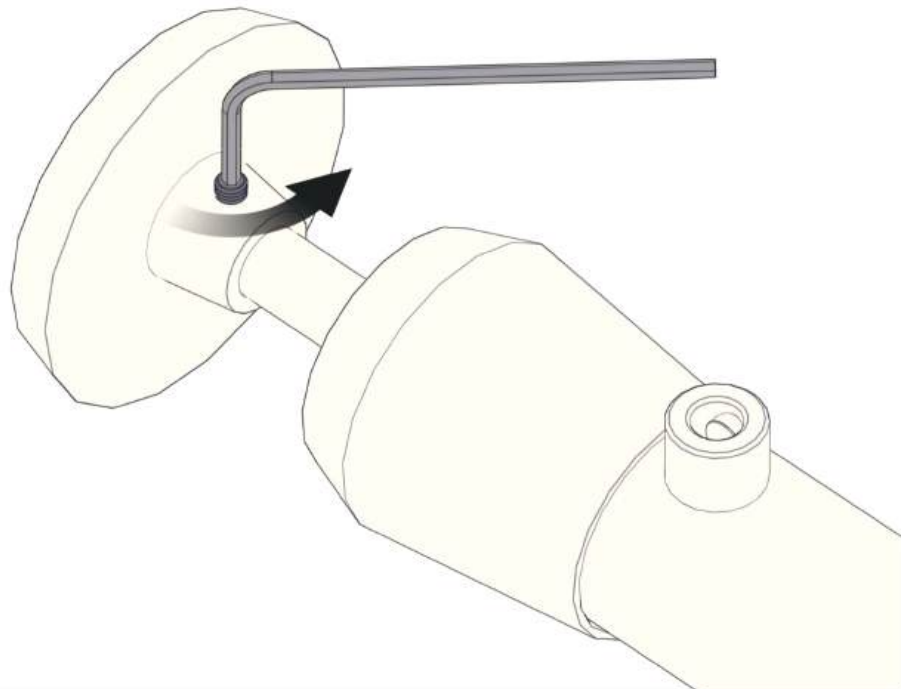

4.6

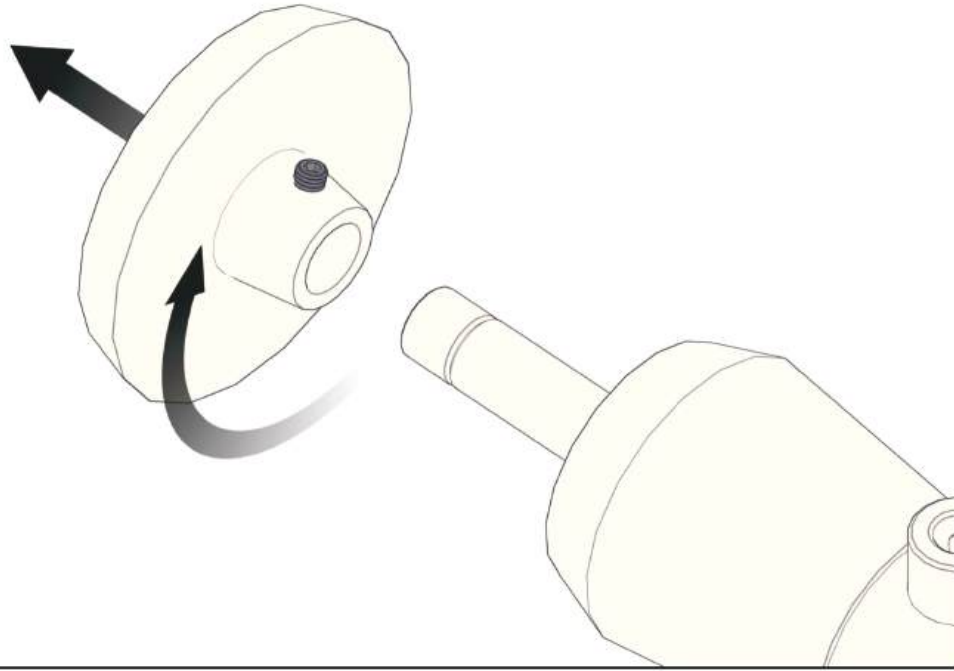

4.7

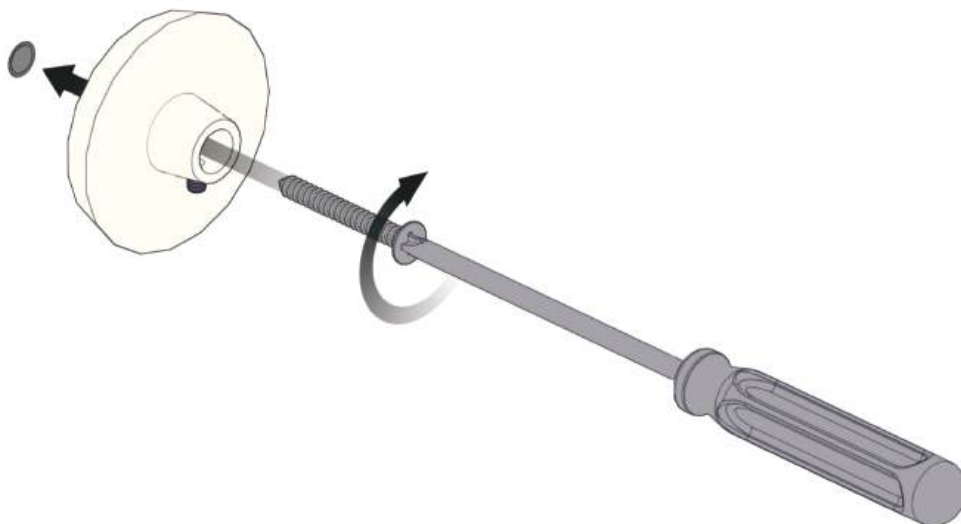

4.8

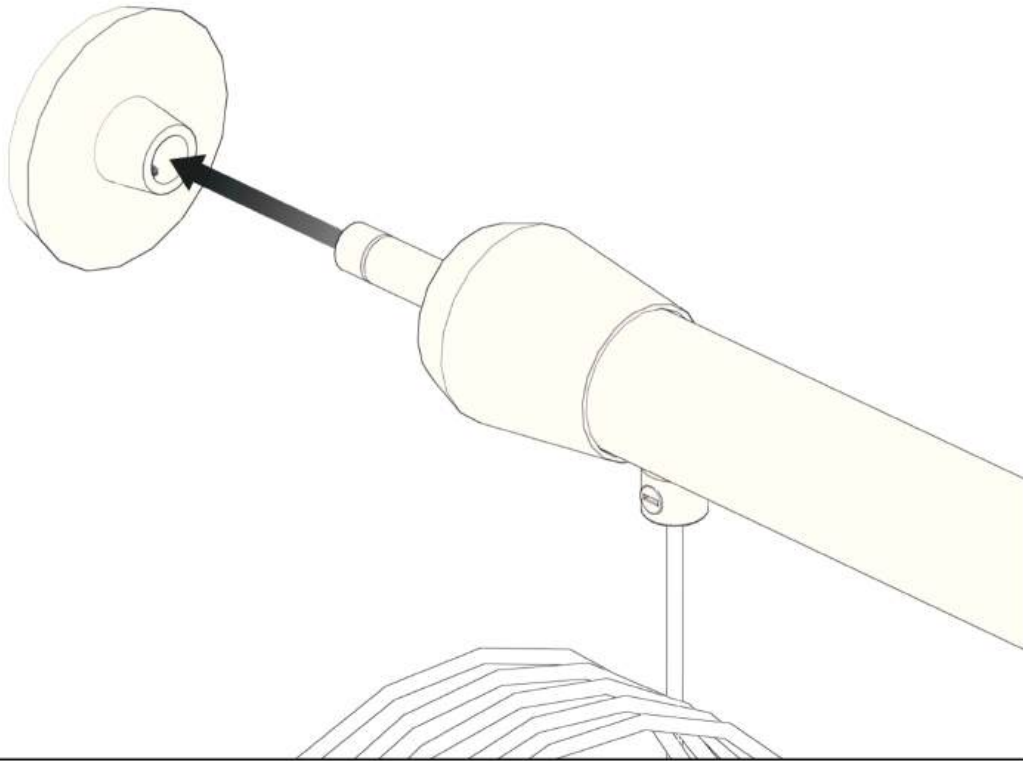

4.9

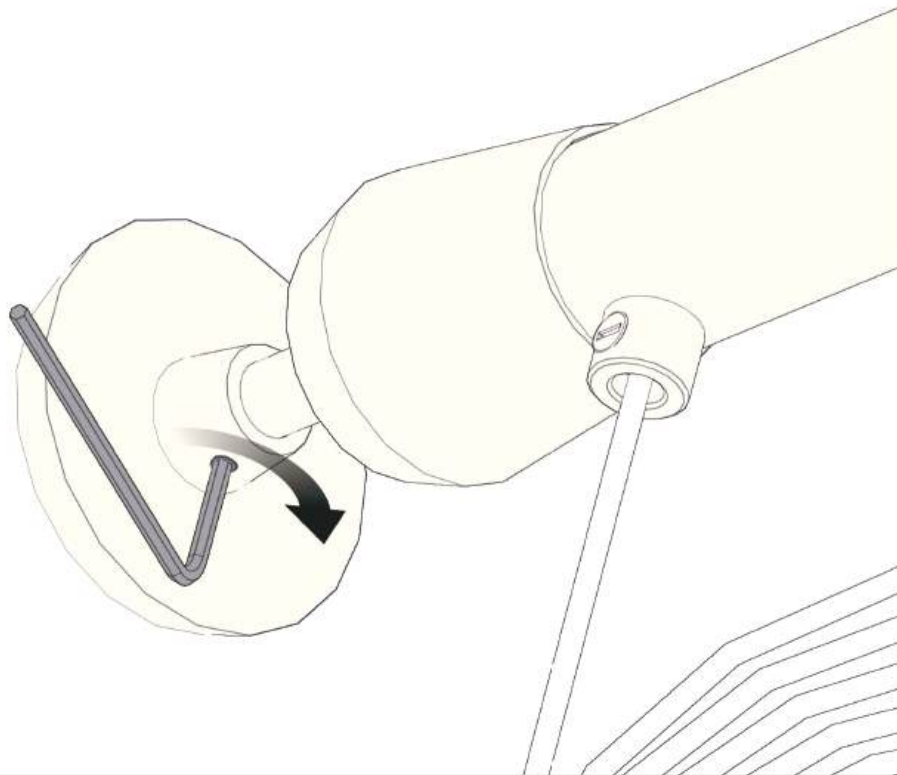

5.1

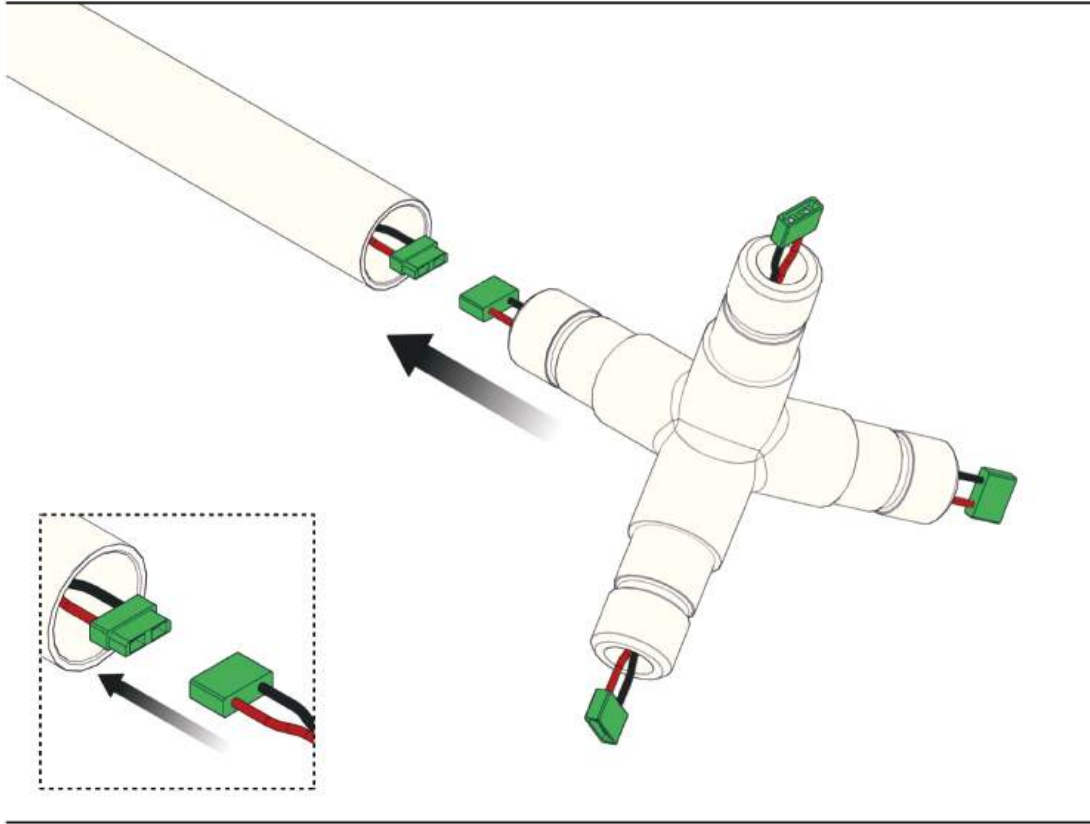

5.2

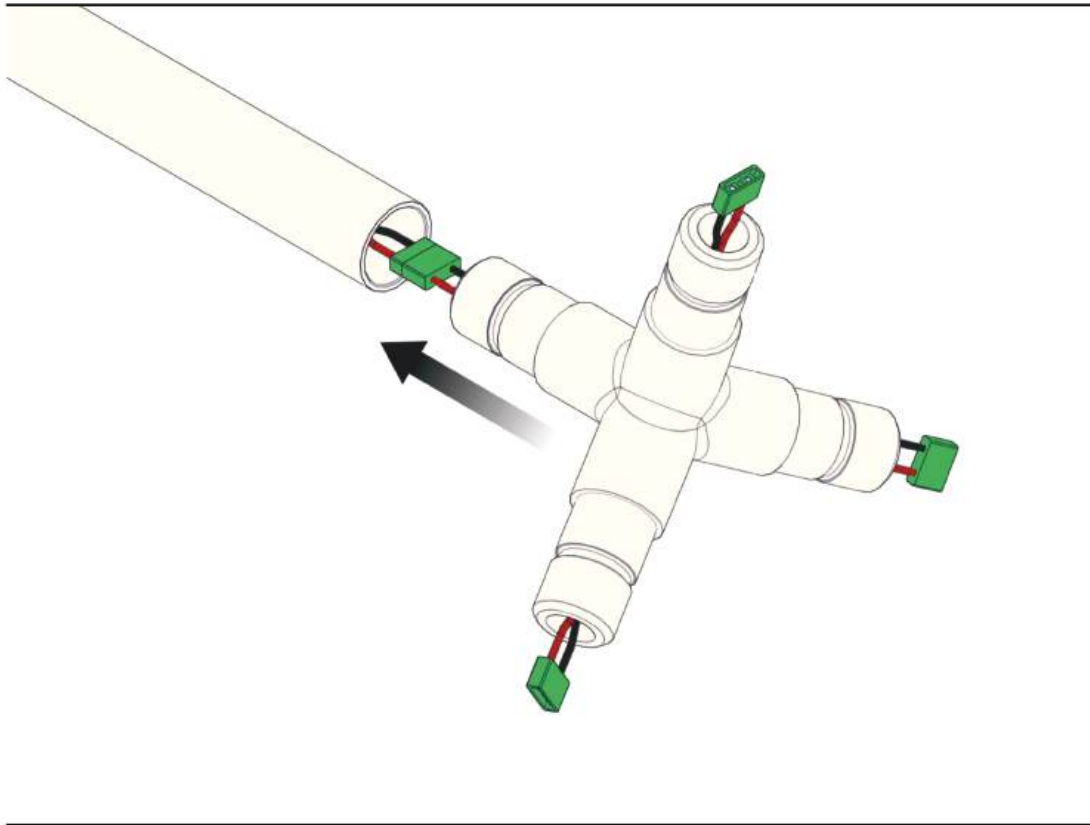

5.3

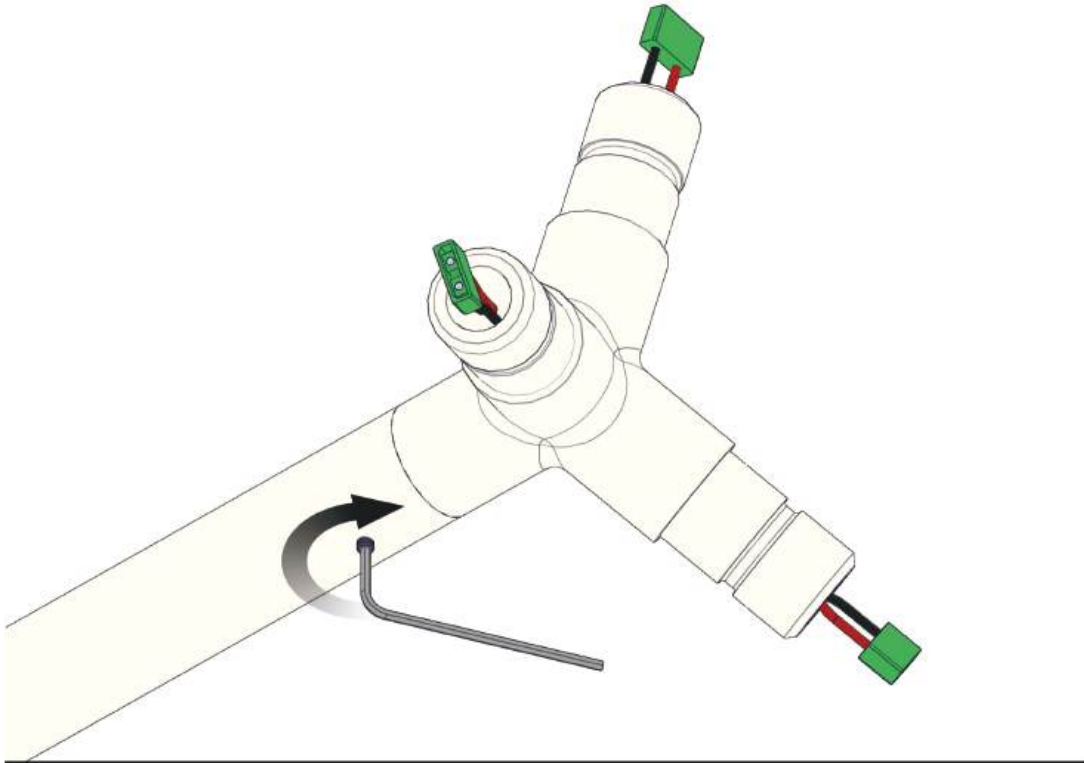

5.4

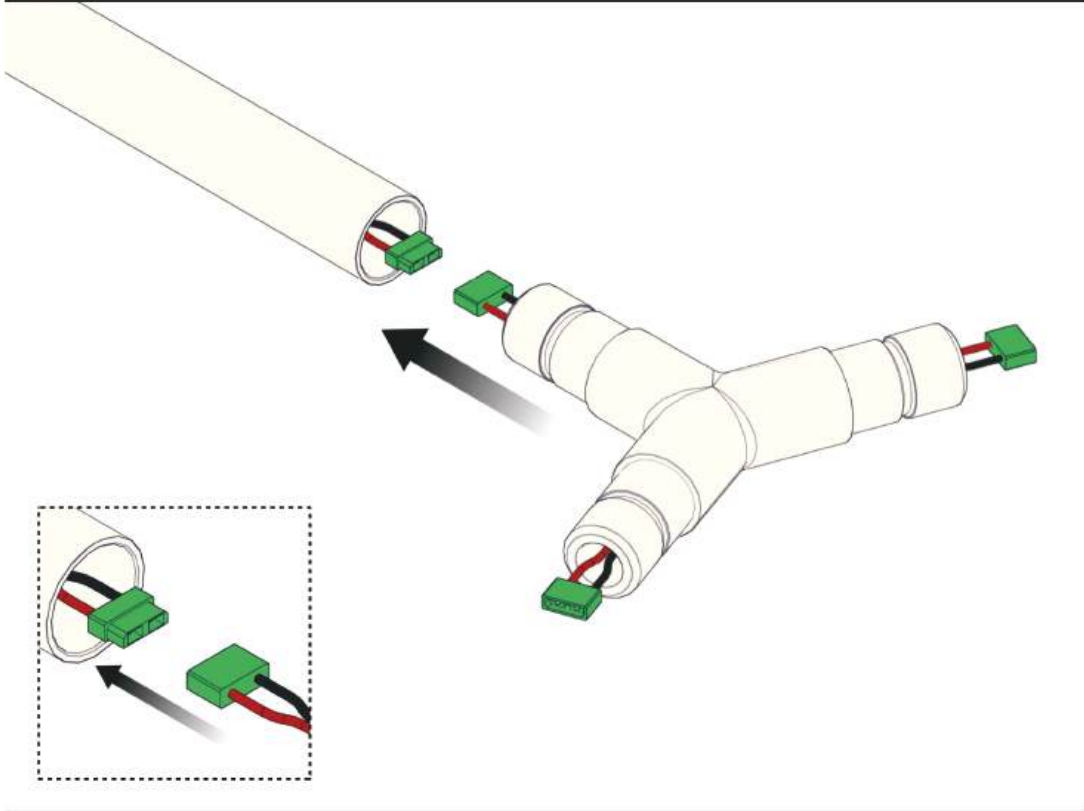

5.5

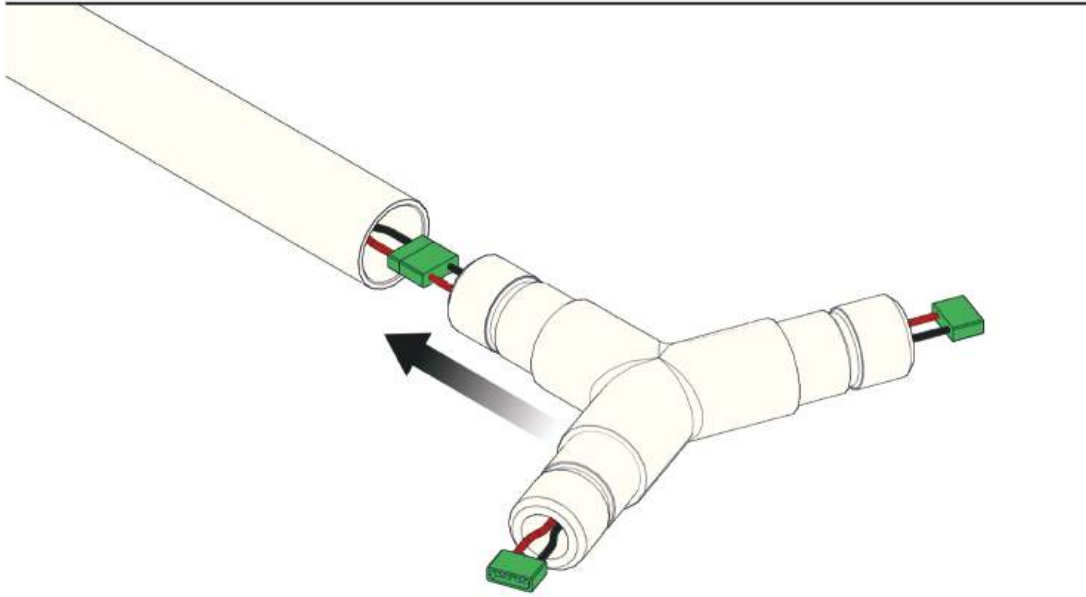

5.6

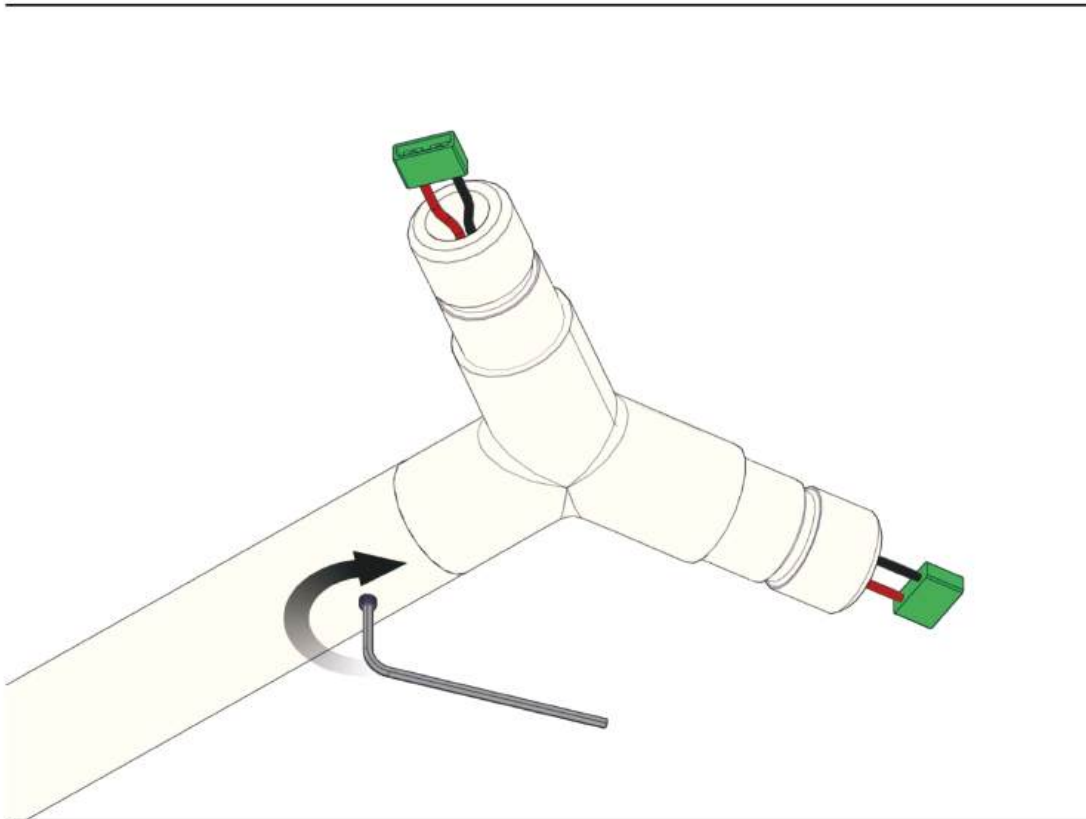

5.7

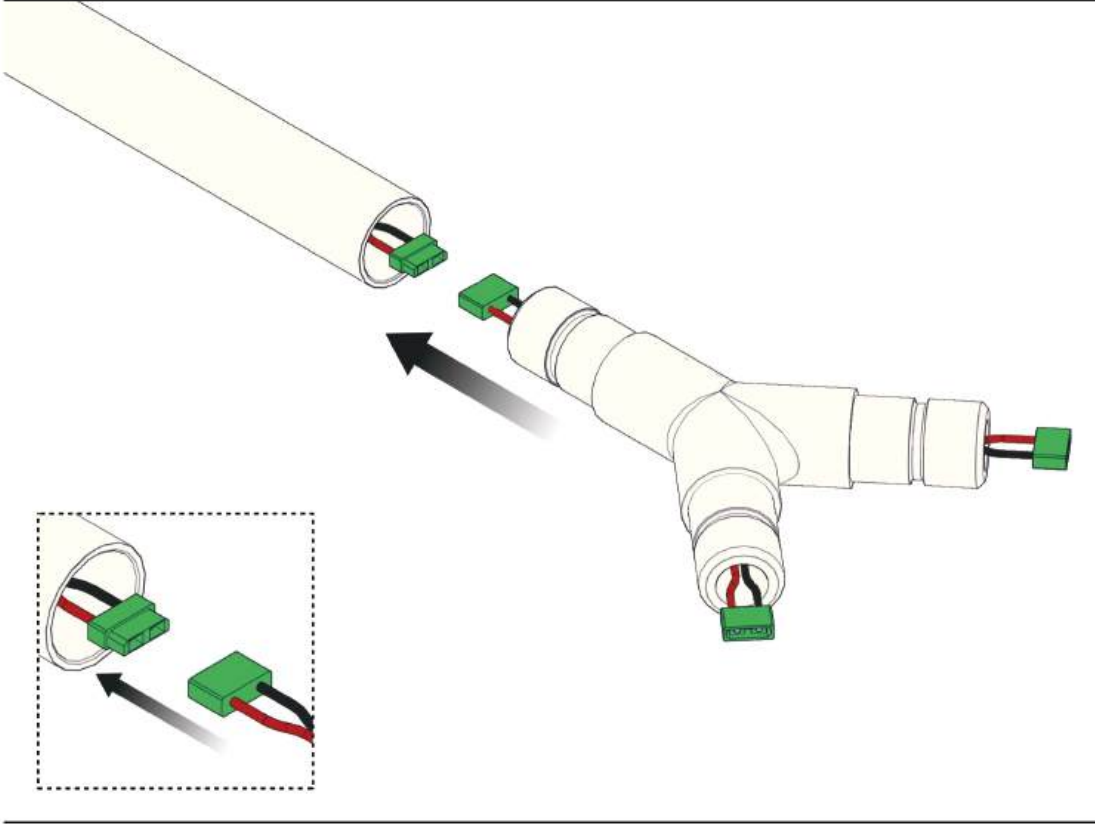

5.8

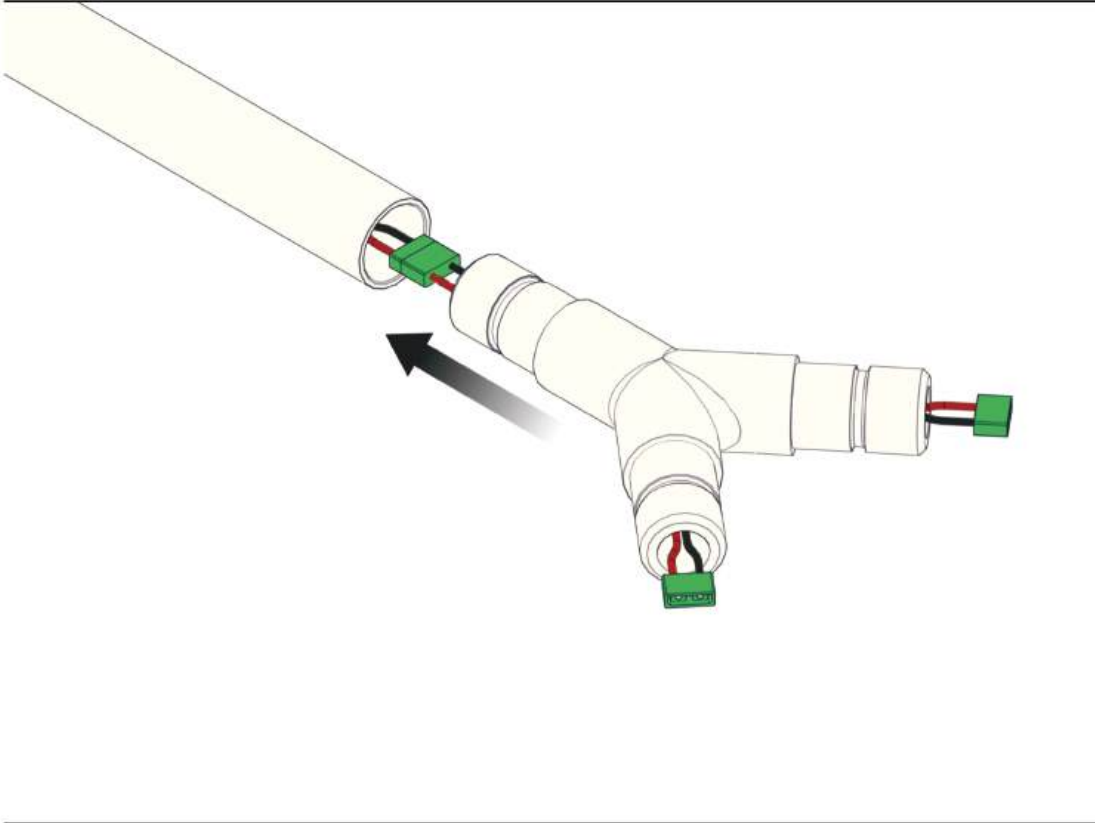

5.9

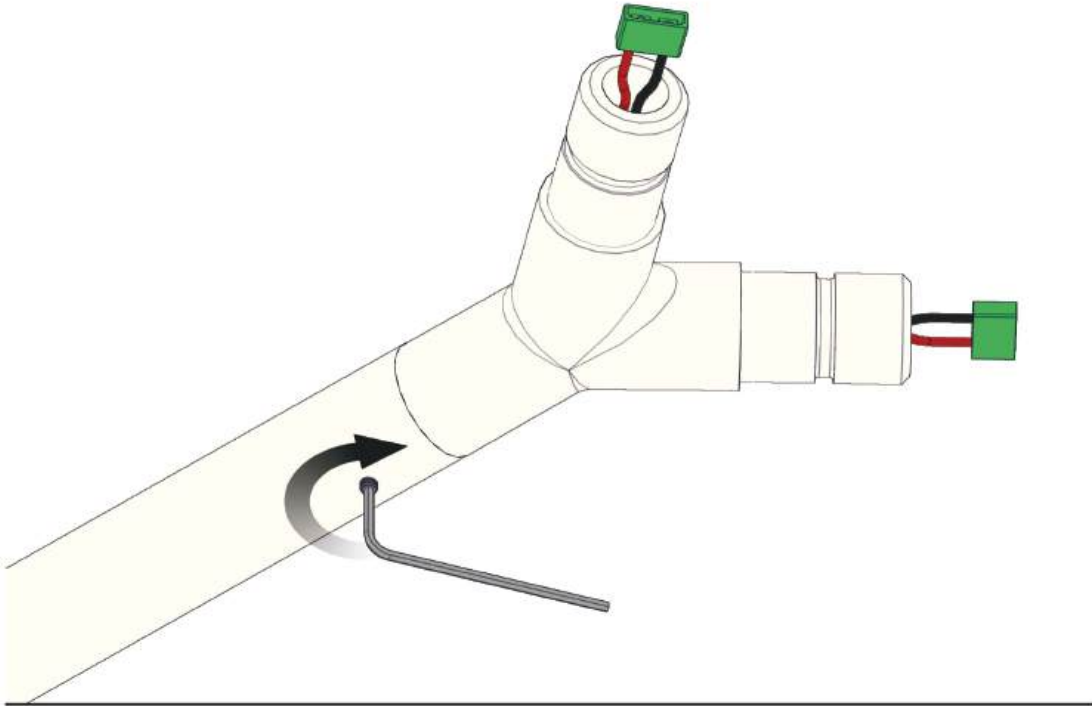

5.10

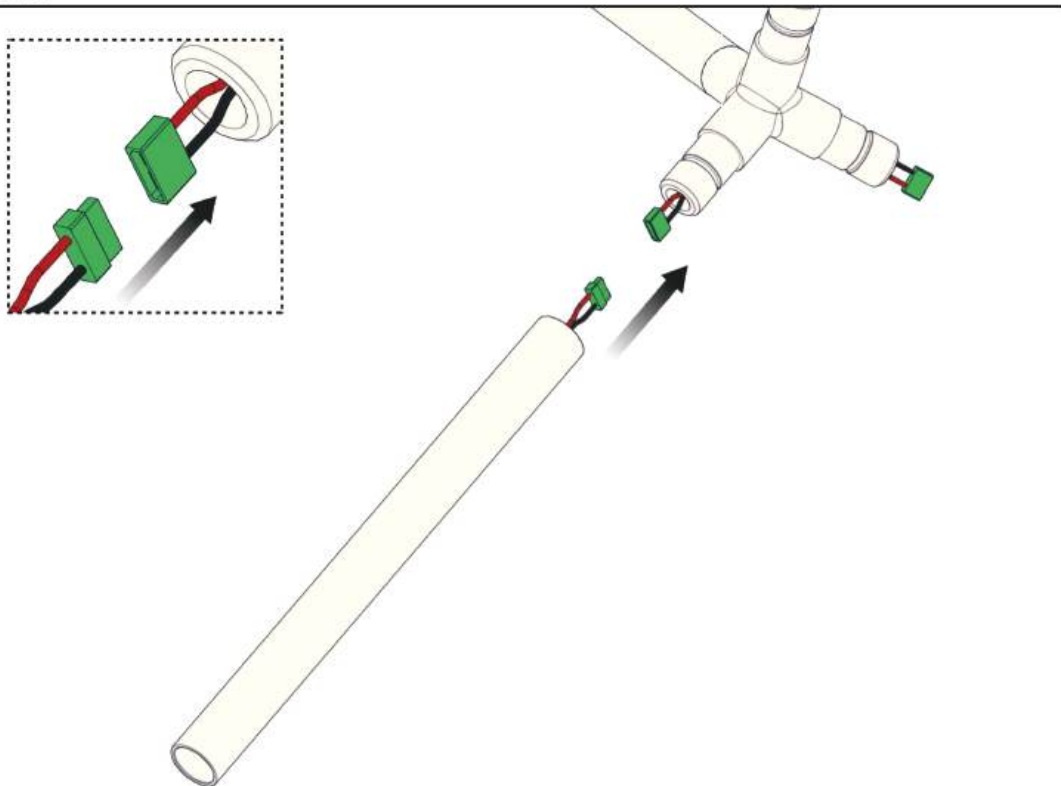

5.11

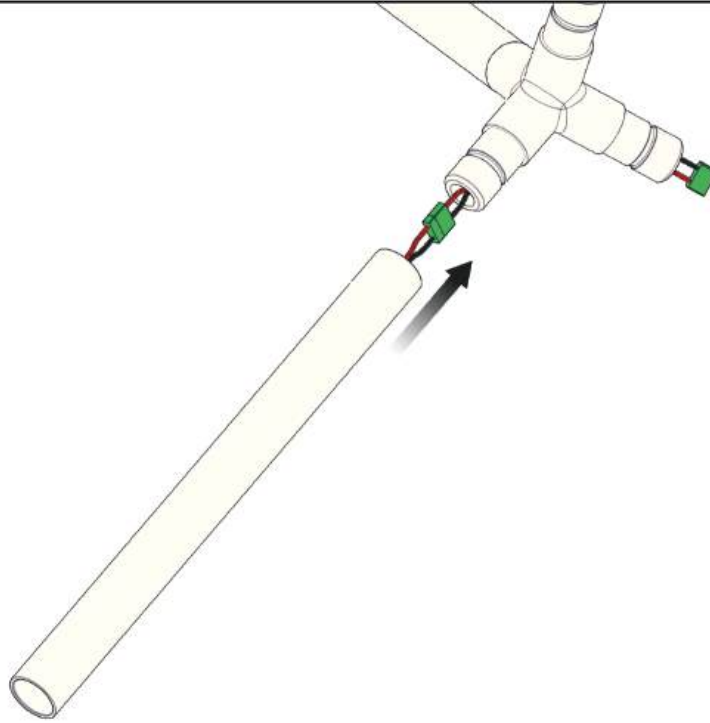

5.12

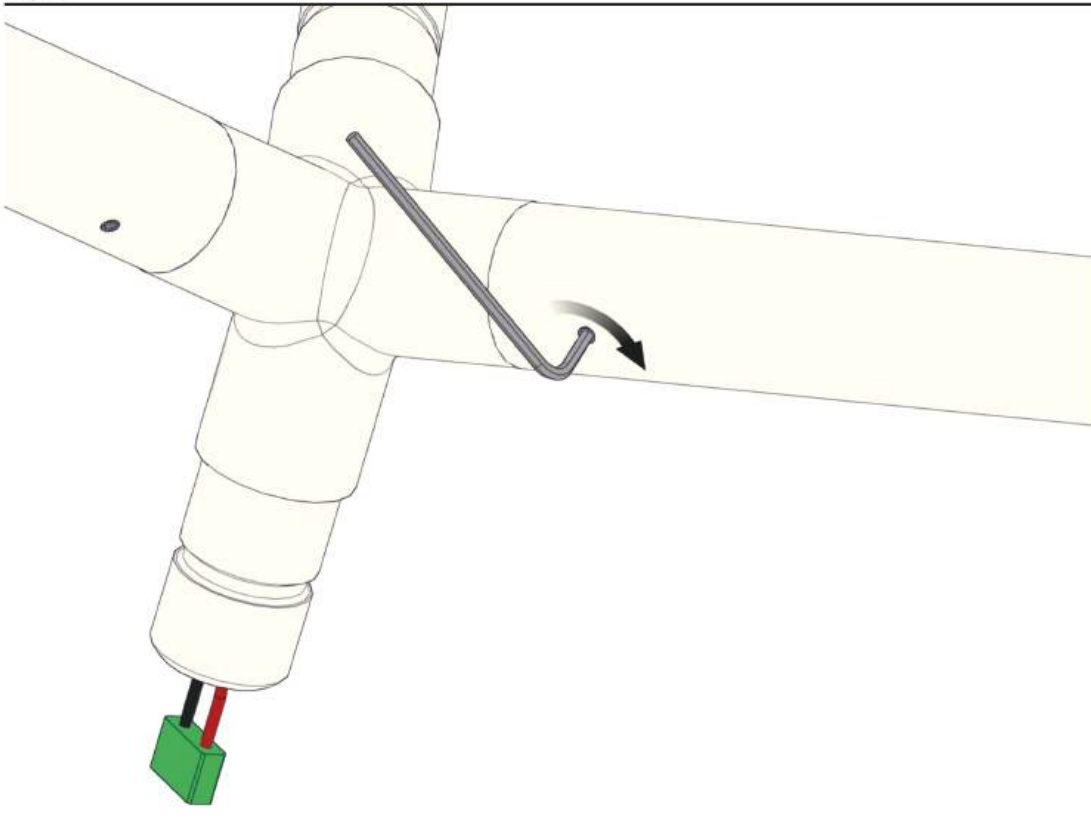

5.13

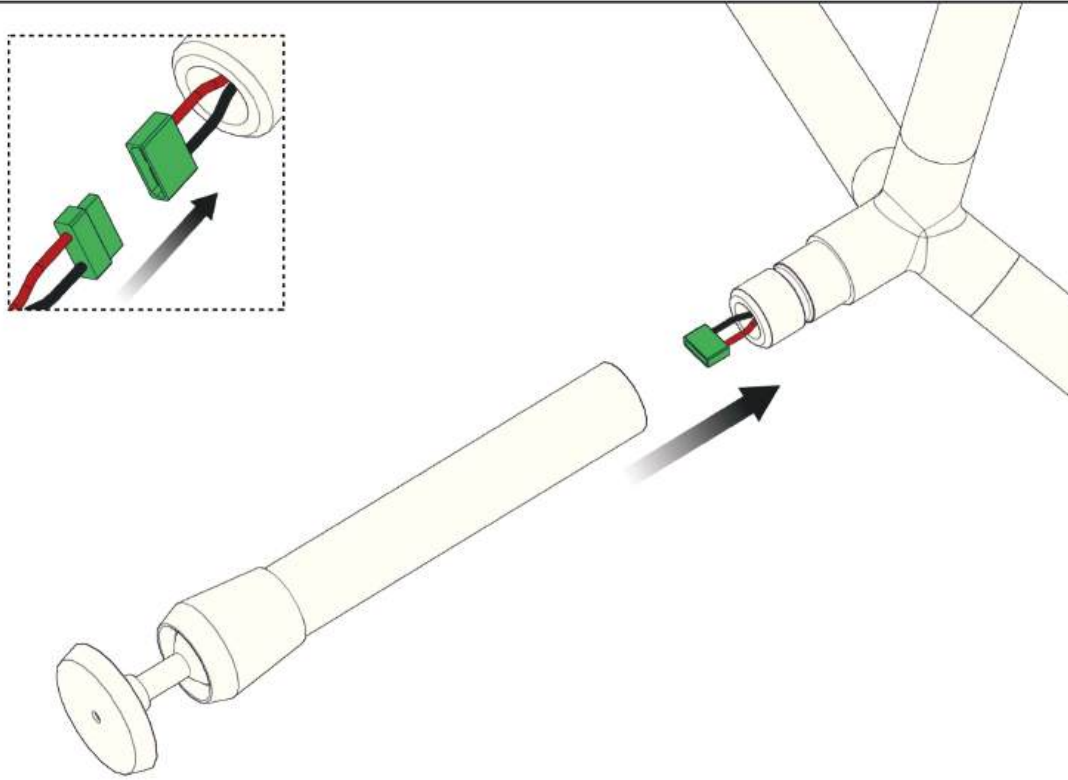

5.14

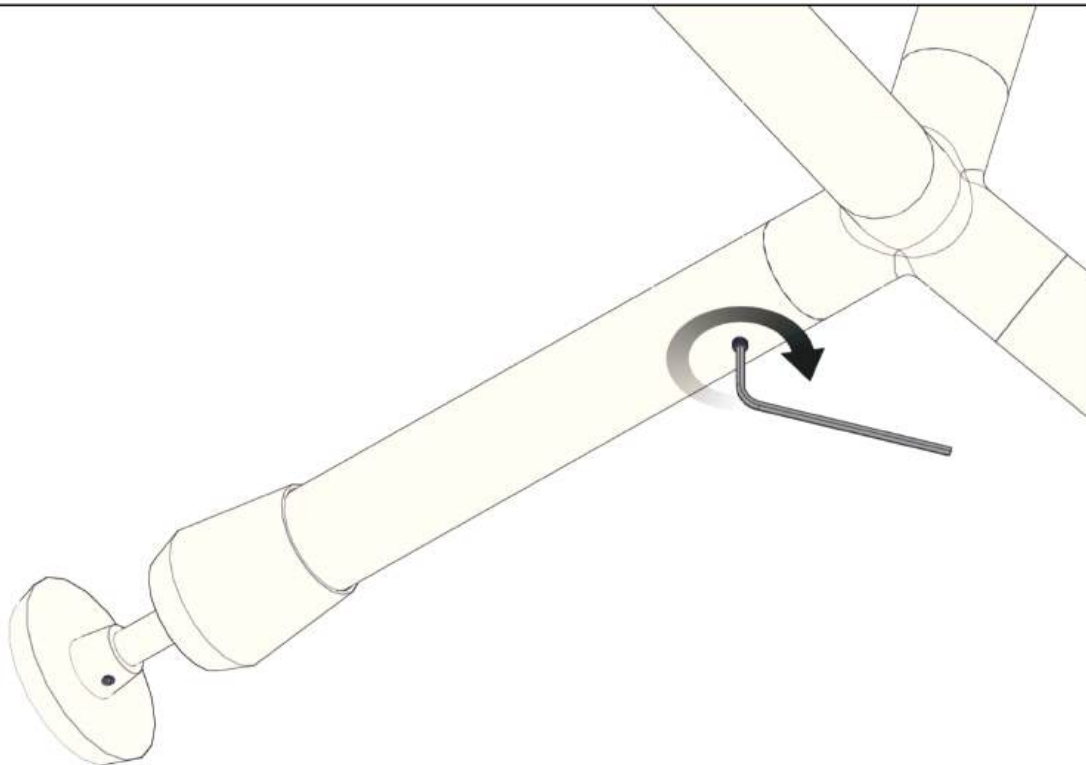

5.15

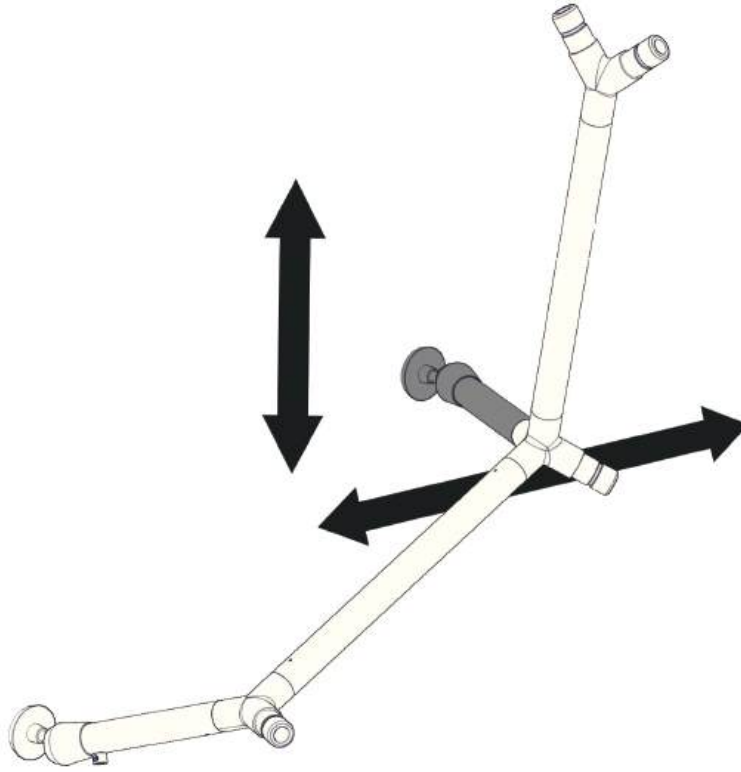

5.16

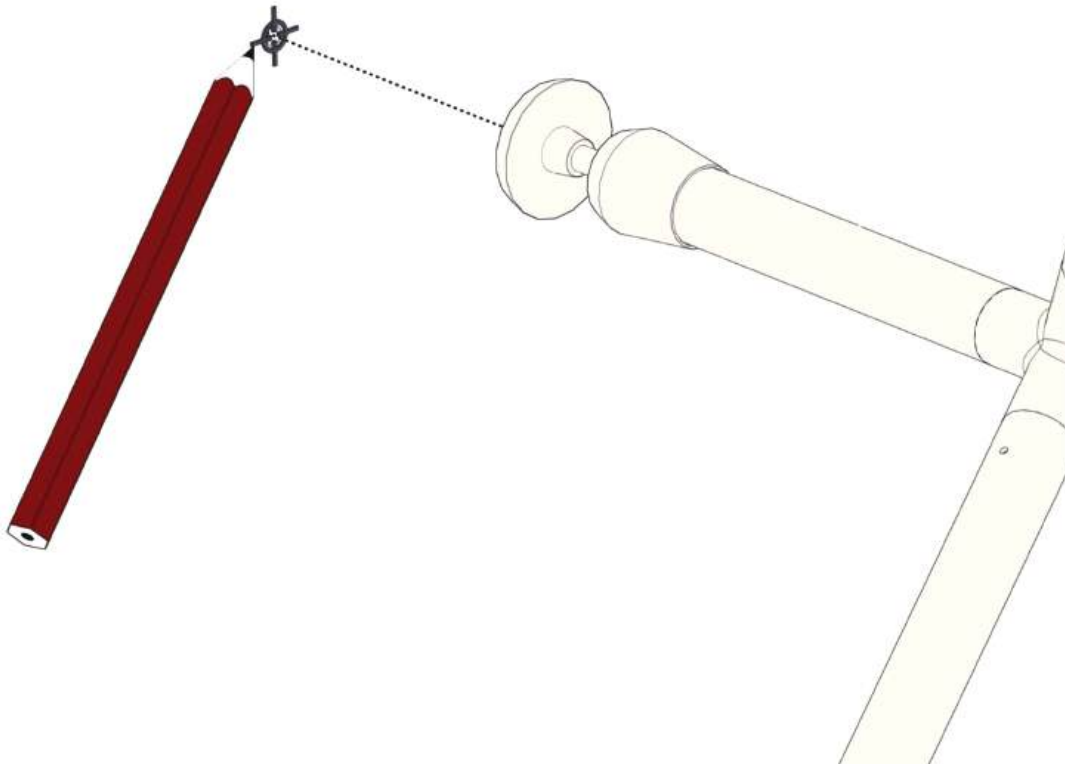

5.17

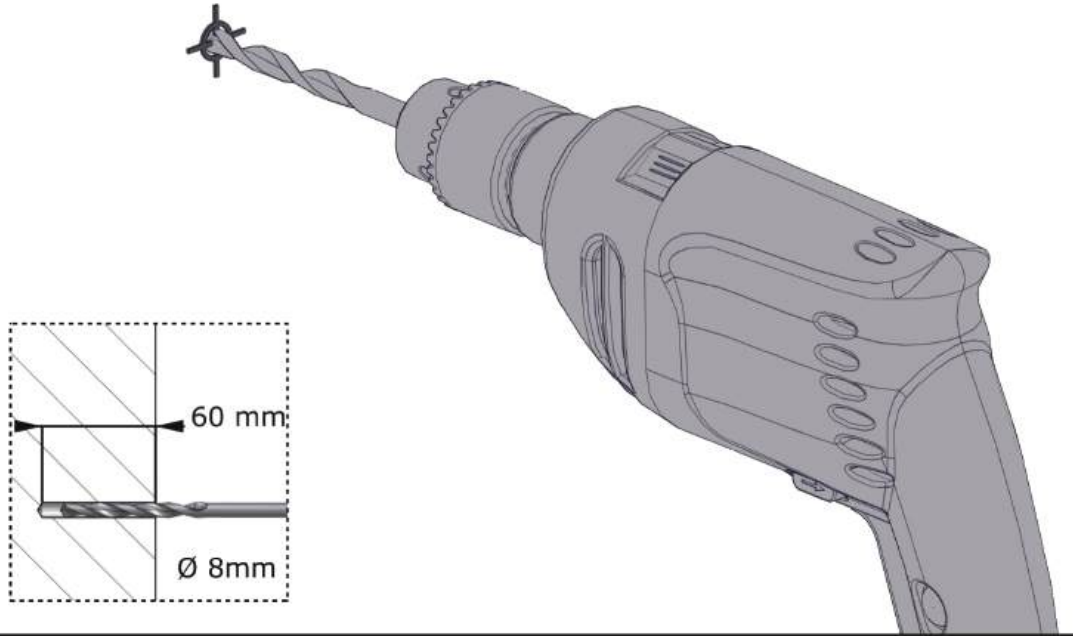

5.18



5.19

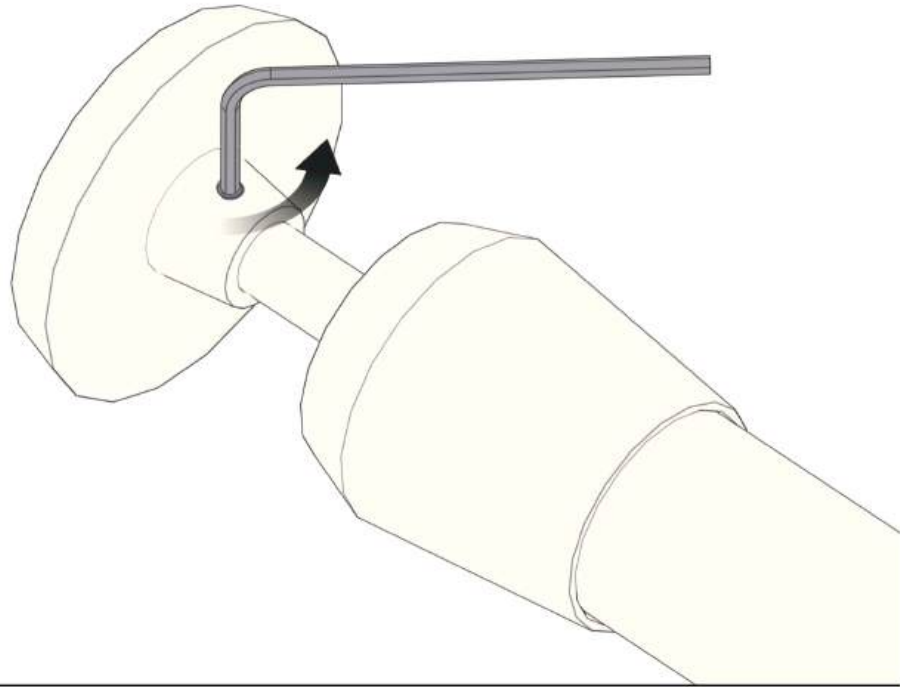

5.20

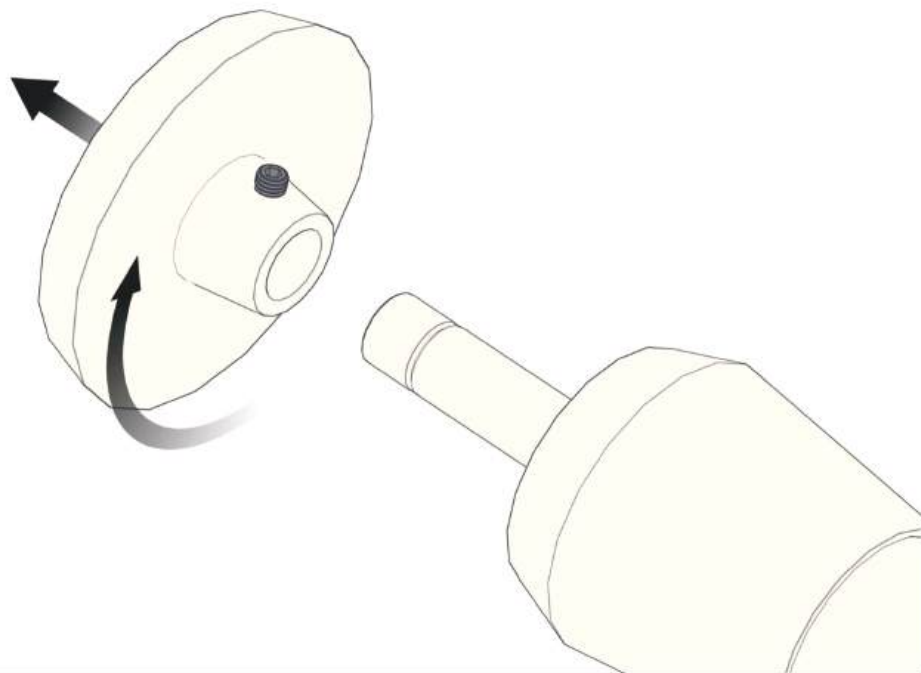

5.21

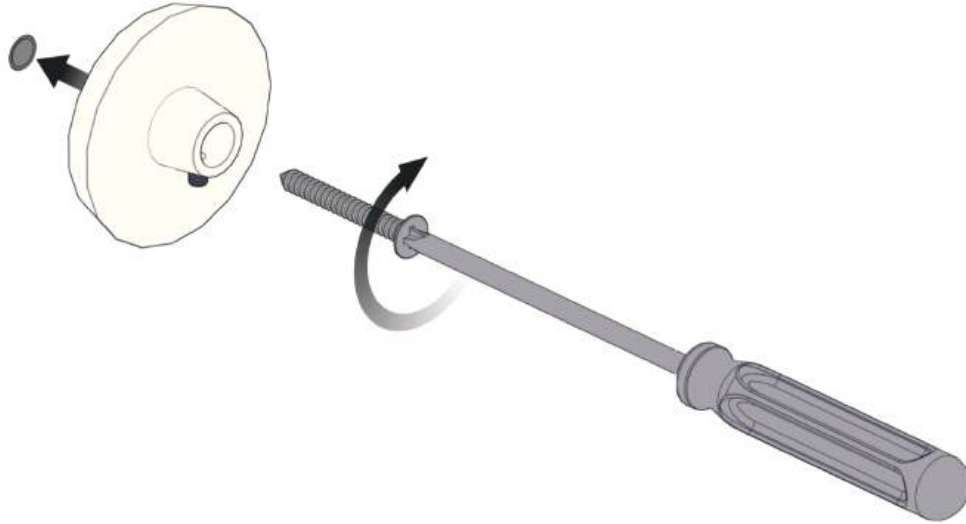

5.22

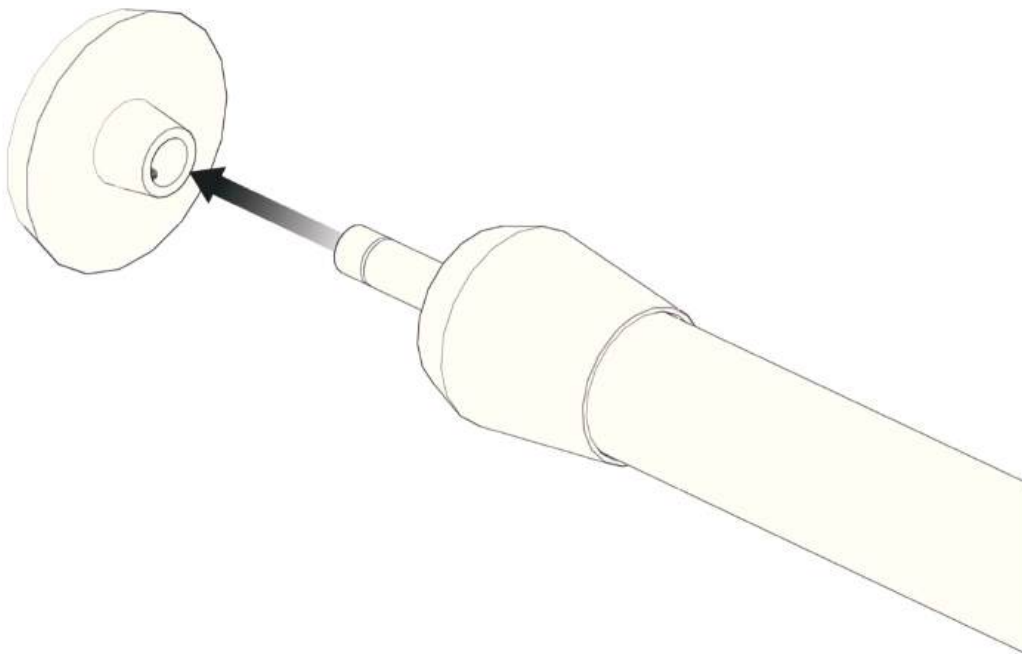

5.23

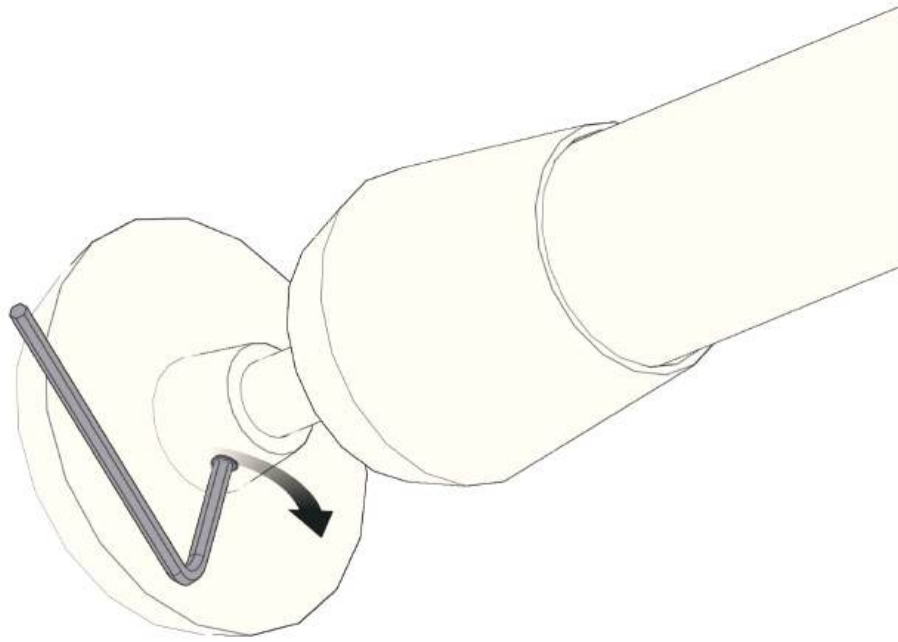

6.1

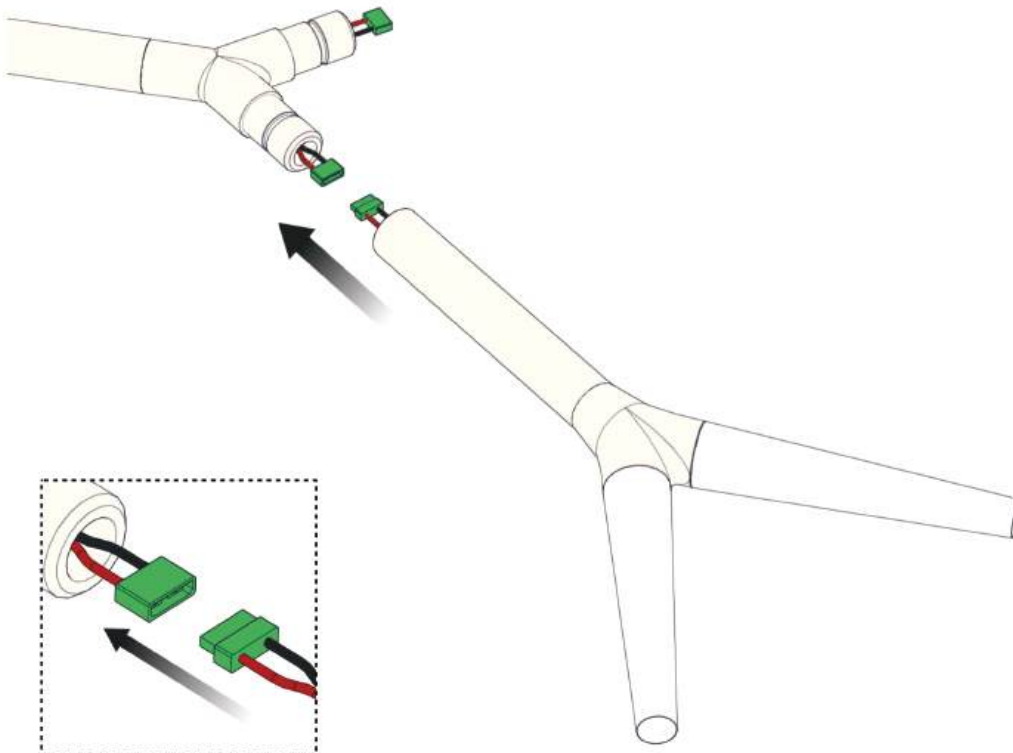

6.2

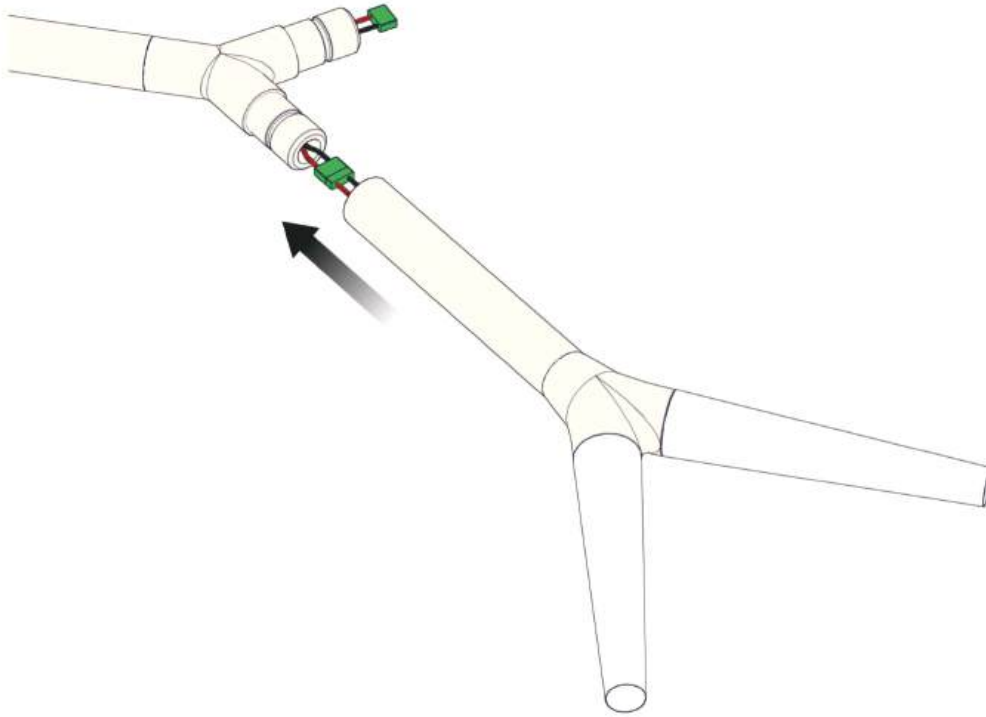

6.3

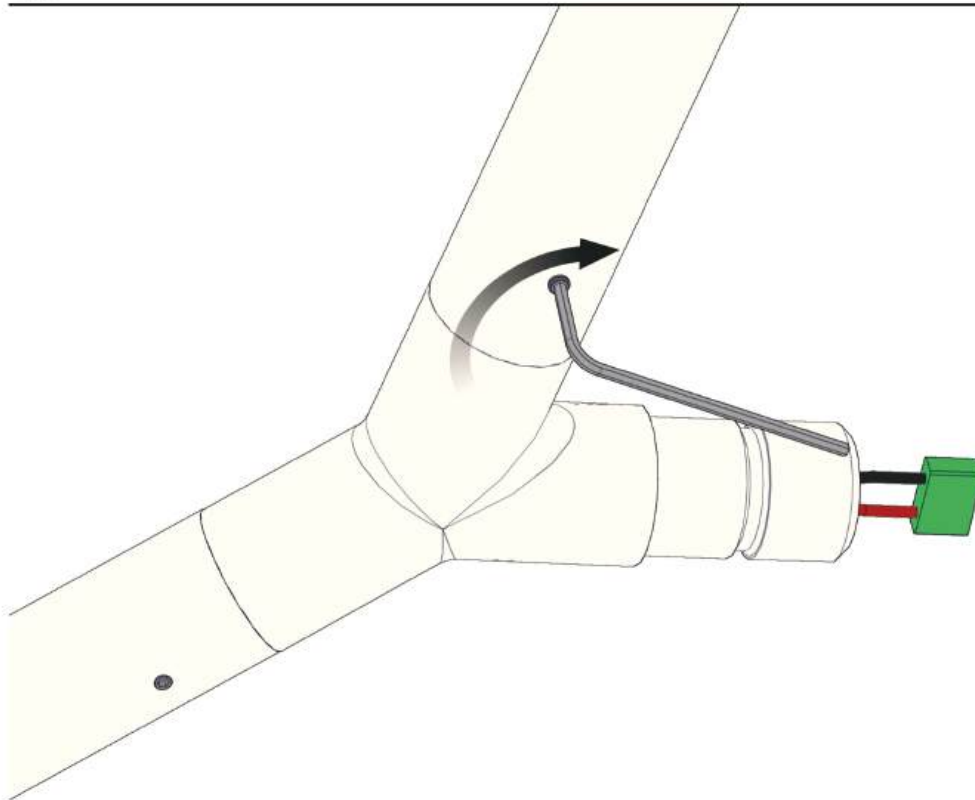

6.4

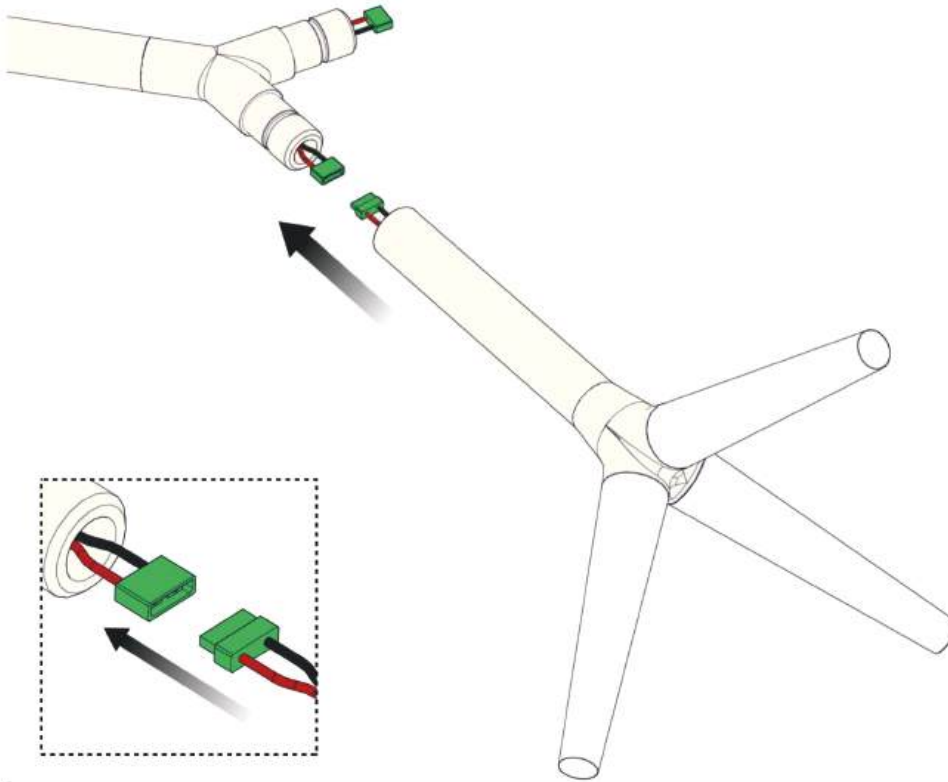

6.5

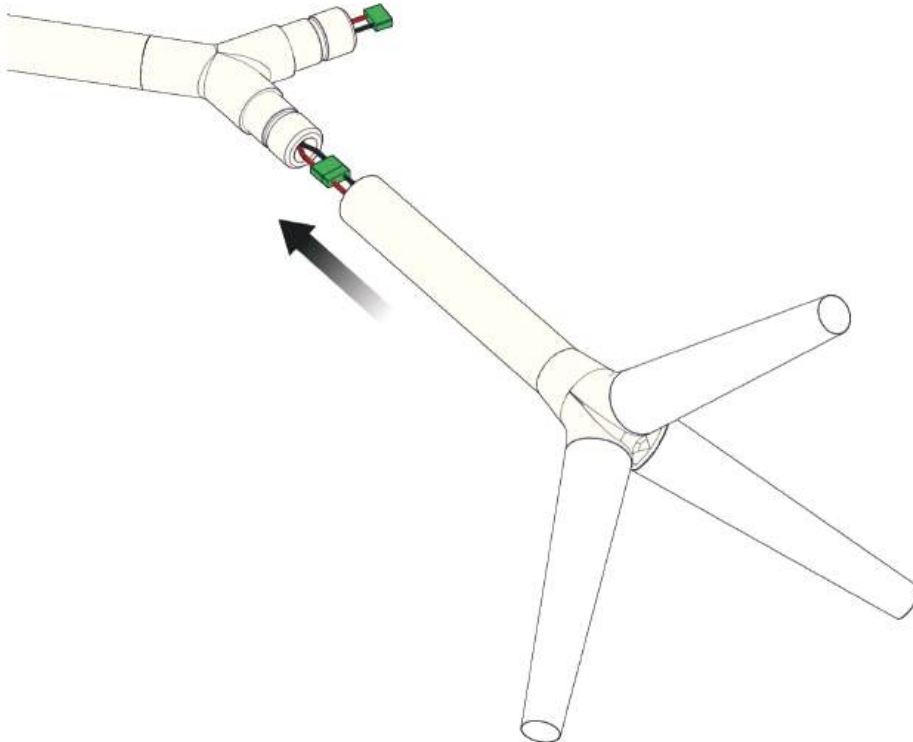

6.6

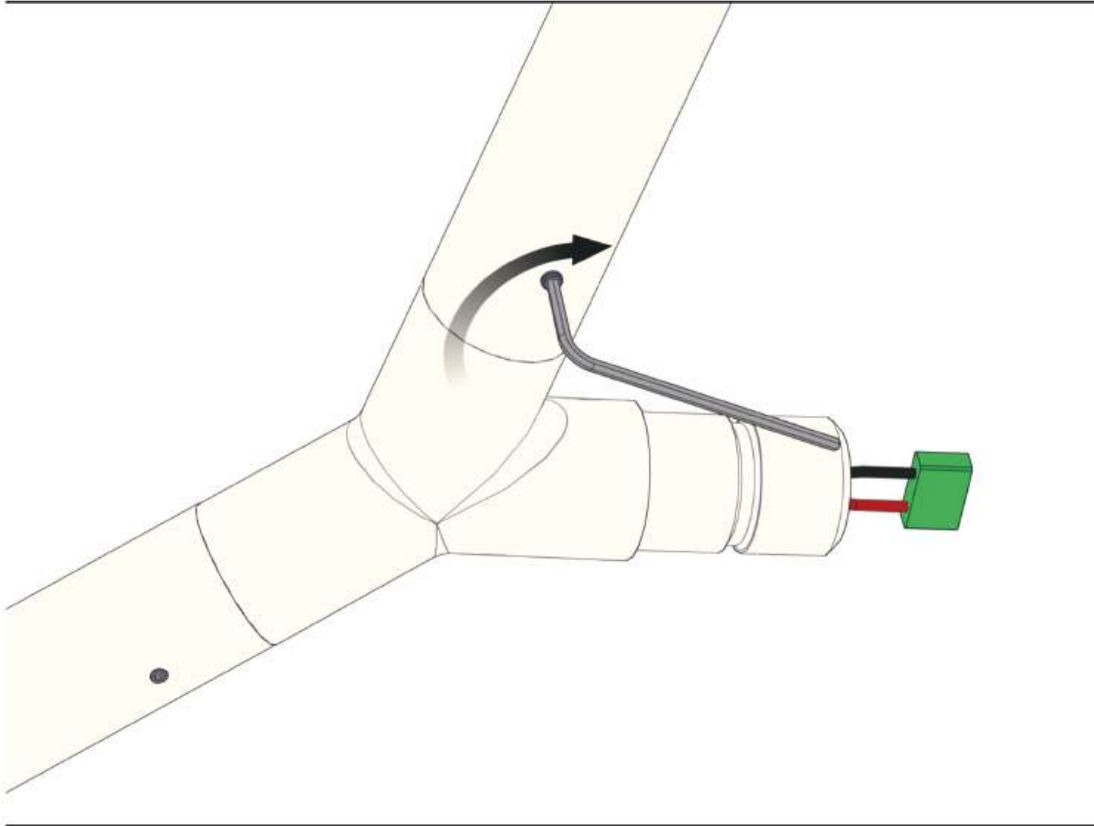

Post Sales Support

HQ 1-800-388-3382 support@zaneen.com



EN

- Installation and electrification must be carried out by a qualified electrician, only.
- Observe all relevant building codes and regulations.
- Prior to installation or repair: disconnect power; it is the installer's responsibility to ensure for all electrical, mechanical and thermal compatibility.
- The LED light source contained in this fixture shall only be replaced by Zaneen, or a person approved by Zaneen.
- Recommendations: Keep the instruction sheet(s) in the event of maintenance and/or disassembly.

Access detailed spec sheets from www.zaneen.com

FR

- L'installation et l'électrification doivent être effectuées uniquement par un électricien qualifié.
- Respectez tous les codes du bâtiment et réglementations en vigueur.
- Avant l'installation ou la réparation: débranchez l'alimentation électrique; Il incombe à l'installateur des'assurer de la compatibilité électrique, mécanique et thermique.
- La source de lumière LED contenue dans ce luminaire ne doit être remplacée que par Zaneen, ou une personne approuvée par Zaneen.
- Recommandations: Conservez la (les) fiche (s) d'instructions en cas de maintenance et / ou de démontage

Accéder aux fiches techniques détaillées sur www.zaneen.com

Disclaimer: Applicable only when Zaneen's lighting fixtures are properly installed on correct line voltage, and under normal conditions of use.

Zaneen Warranties are itemized below:

- All products to be free from defect in materials and workmanship: 1 Year (12 months) Limited Warranty from the invoice date (excluding lamps)
- LED engines and Power Supplies: 5 Years Limited Warranty from the invoice date.
- Transformers and Ballast Warranty: 3 years Limited Warranty from the invoice date.
- Purchaser's sole recourse after the warranty period, for defective power supplies, ballasts or other components manufactured by a third party, is against such third-party manufacturer.

Warranty claims regarding the product(s) must be submitted in writing within 30 days, of discovery of the defect.

Zaneen uses only electrical components, which are produced by responsible manufacturers. Components that may fail in service within the warranty period, under normal use, will be replaced at no charge.

Zaneen will not assume labour or transportation charges in connection with replacement of such parts, nor for removal or re-installation of equipment or parts, nor for consequential damages or losses.

The warranty extended to Zaneen by the manufacturers of the electrical components is passed on to our customers.

At its option, Zaneen will repair or replace, any fixture defective as provided herein if such fixture is returned by the purchaser within the warranty period, provided Zaneen has issued a written "Return Goods Authorization". Such repair or replacement is the exclusive remedy against Zaneen and Zaneen is not responsible for damage of any sort whatsoever, including incidental and consequential damages or losses.

This warranty extends only to replacement defective fixtures or components and no allowance will be made for labour or transportation charges in connection with replacement of such parts, nor for removal or re-installation of equipment or parts unless specifically authorized in writing by Zaneen prior to any work being performed.

This warranty only applies when the products are installed in applications in which ambient temperatures are within normal temperatures and are operated within the electrical values shown on the LED driver label.

Zaneen Interior rated luminaries are not protected from environmental conditions, such as salt content from sea air. Therefore, any damages resulting from exposure to salt air, or other harmful environmental conditions, will not be covered under Zaneen Warranty.

Zaneen will not be responsible under warranty for any failure of the product that results directly or indirectly from improper installation and/or external causes such as: acts of nature, physical damage, and exposure to adverse or hazardous chemicals or other substances, use of harsh cleaning agent or harsh chemicals.

Warranty for any substantial deterioration in the product finish caused by failure to clean, inspect or maintain the finish of the product. The end user is responsible for the structural integrity of existing foundations, anchorages, or structures and all consequences arising from their use.

Zaneen will not be responsible under warranty for any failure of the product that results directly or indirectly from improper installation and/or external causes such as: acts of nature, physical damage, and exposure to adverse or hazardous chemicals or other substances, use of harsh cleaning agent or harsh chemicals.

The end user is responsible for the structural integrity of existing foundations, anchorages, or structures and all consequences arising from their use.