

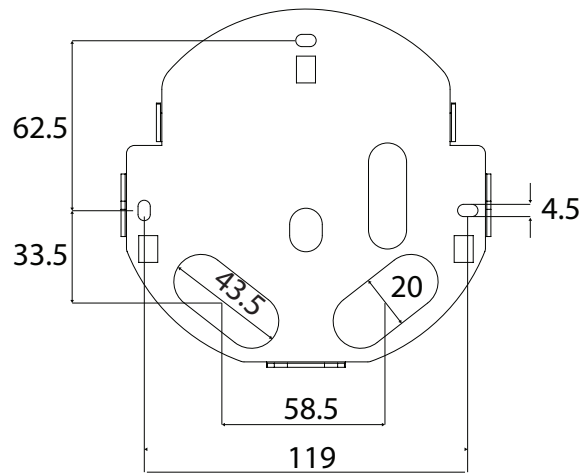

TECHNICAL DATA

TEAM Round -		IP 66 - IK 09
Category	Class	Power supply
ASTER Basic small		
8W LED White	⊕	120-277V 50/60Hz - 0-10V Dimming

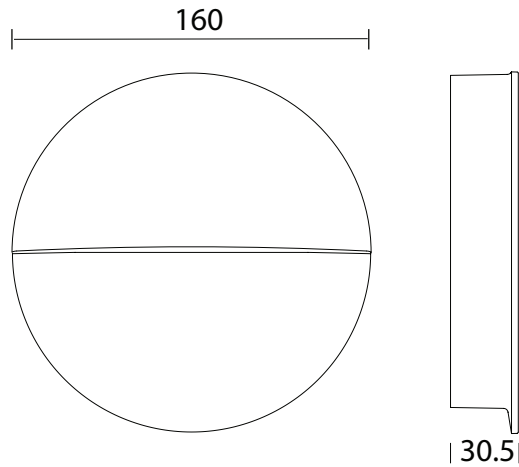

TECHNICAL DATA



LED MODULE

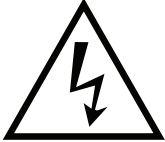

CAUTION: Make sure that the lines are protected from over-voltage.

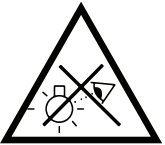

LED-Module risk group 1. Do not look into the beam.
In case of malfunctions with the LED module, please contact Zaneen.



We do not recommend switching on the fitting during the day with strong solar radiation.

TECHNICAL INFORMATION

Front frame and back body made in die-cast aluminium alloy, painted and resistant to corrosion. Protection by means of anodizing treatment, first layer of epoxy powder and polyester final painting. A4 stainless steel screws, wall fixing bracket made in painted stainless steel. No visible screws. Diffusing lens made in methacrylate with high lighting performances. That allows a big interdistance of installation between fittings, while having uniform lighting. Product operated by mains voltage.

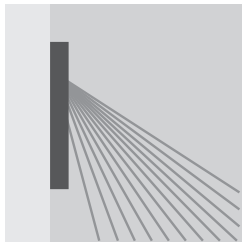

A high luminous efficiency diffusing methacrylate lens with a very broad beam both transversely and longitudinally.



The methacrylate diffuser lens makes it possible to have a greater distance from one installation to another.

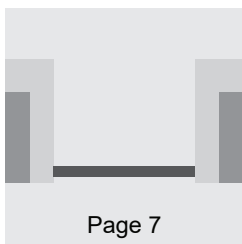

Page 7

The device is also engineered to be connected by means of the electrical plant system to rigid superficial tubes with input for standard 16 mm diameter tubes.

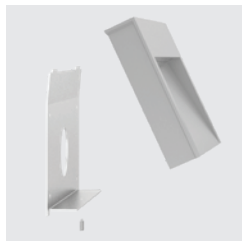

Installation without any wall masonry preparatory work.

WALL INTERNAL CABLE

1/A

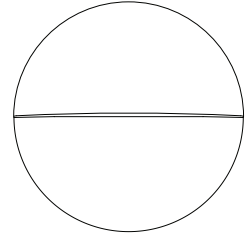

Remote Driver

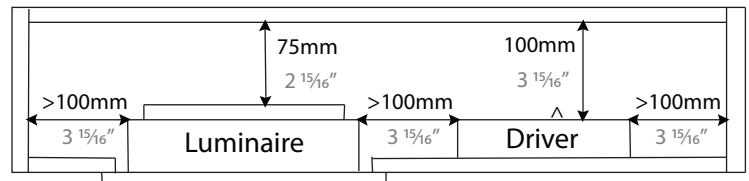

2/A

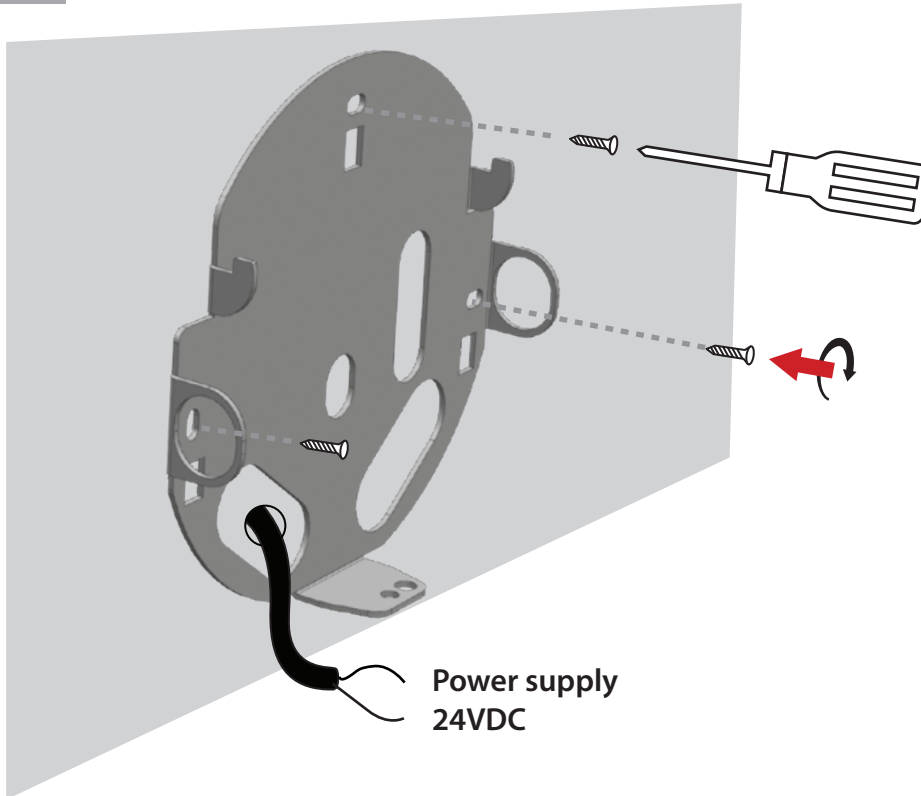

Power supply
24VDC

WALL INTERNAL CABLE

3/A

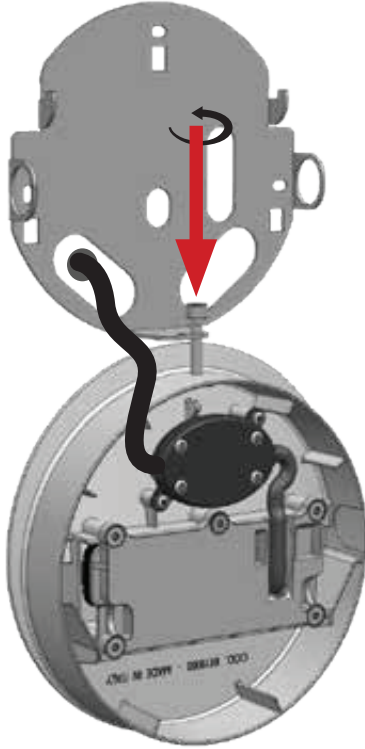

GEL Connector supplied by others



Power supply
24VDC

Remote Driver

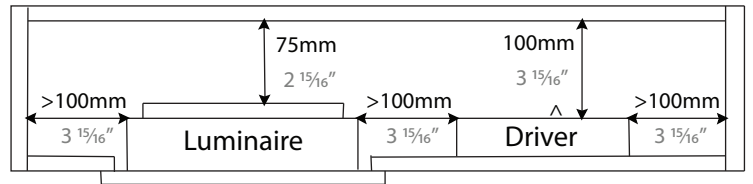

4/A

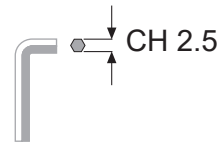

INSTALLATION

1/B

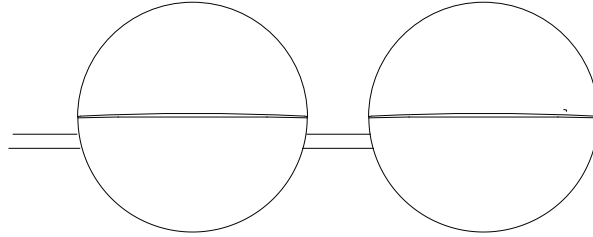

Remote Driver

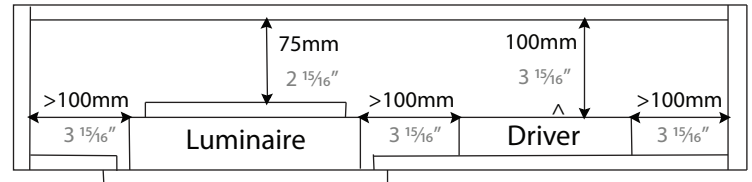

2/B

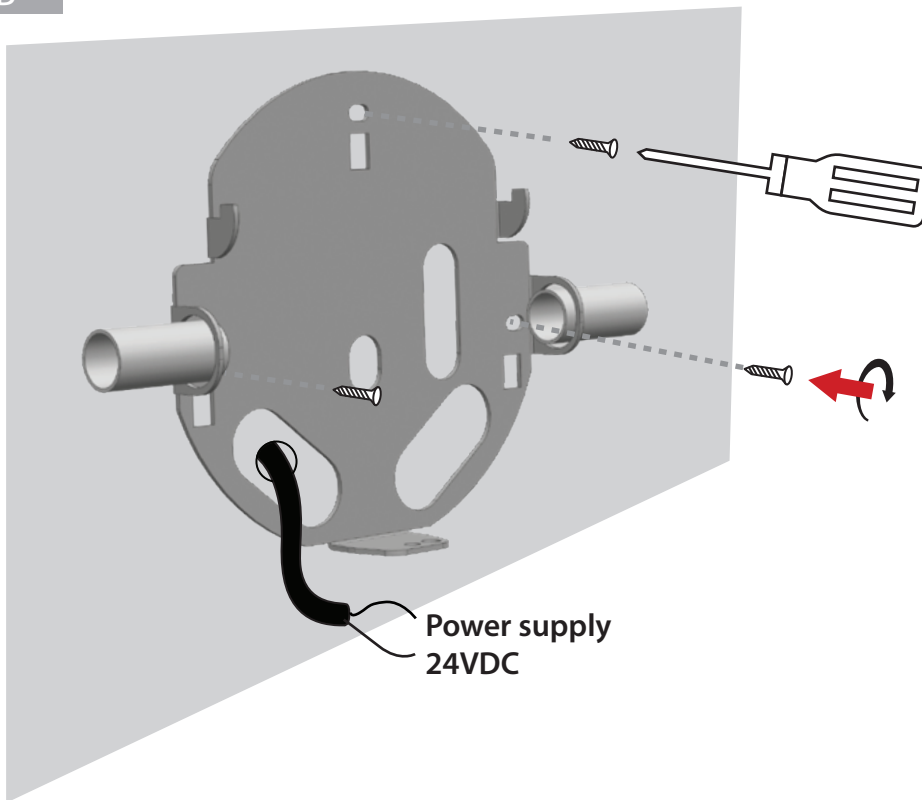

INSTALLATION

3/B

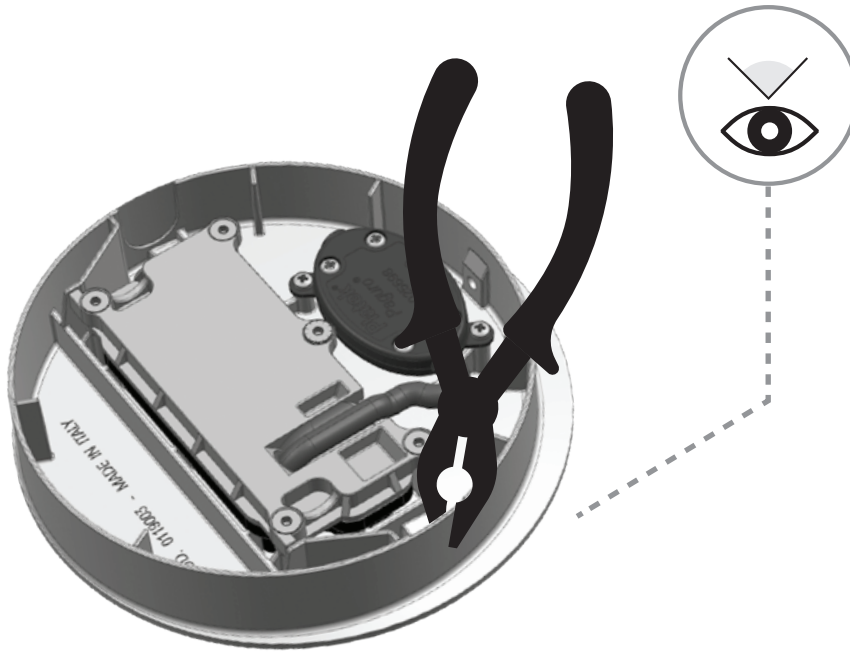

4/B

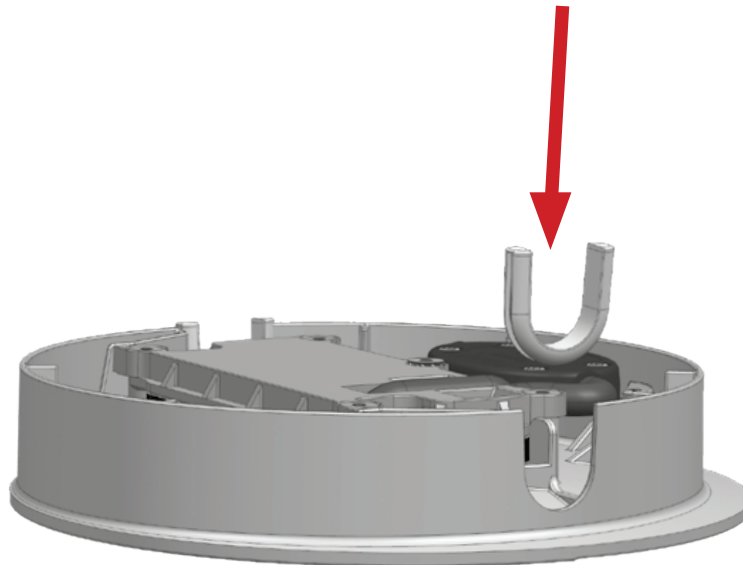

INSTALLATION

5/B

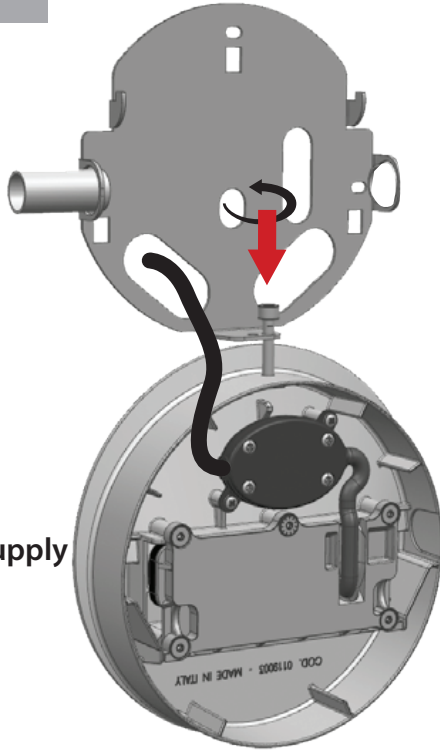

GEL Connector supplied by others



Power supply
24VDC

Remote Driver

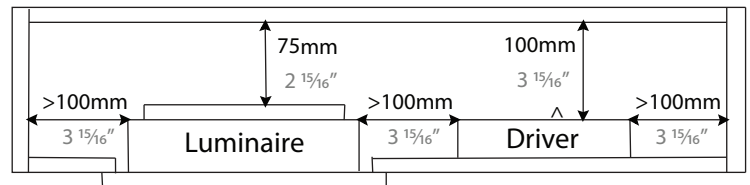

6/B

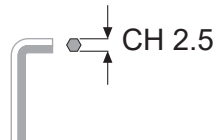
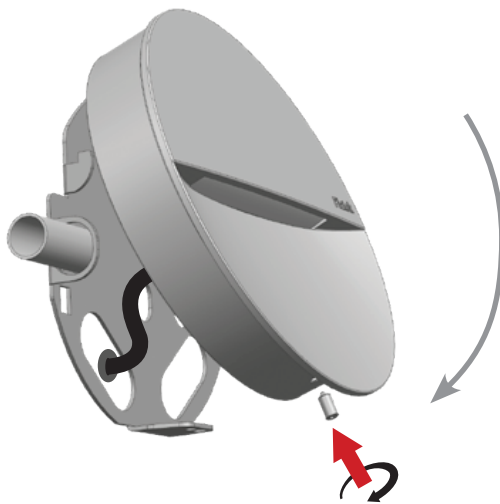

SAFETY AND INSTALLATION WARNINGS

INDOOR - OUTDOOR

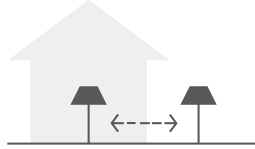

This fixture is suitable for indoor and outdoor use.

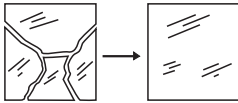

If diffuser is damaged, replace before powering on the fixture.

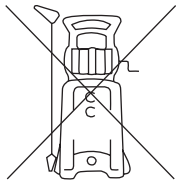

Do not use water high pressur cleaners.

IMPORTANT

Post Sales Support HQ 1-800-388-3382 support@zaneen.com



EN

- Installation and electrification must be carried out by a qualified electrician, only.
- Observe all relevant building codes and regulations.
- Prior to installation or repair: disconnect power; it is the installer's responsibility to ensure for all electrical, mechanical and thermal compatibility.
- The LED light source contained in this fixture shall only be replaced by Zaneen, or a person approved by Zaneen.
- Recommendations: Keep the instruction sheet(s) in the event of maintenance and/or disassembly.

Access detailed specification sheets and the warranty policy on the product page at zaneen.com.

FR

- L'installation et l'électrification doivent être effectuées uniquement par un électricien qualifié.
- Respectez tous les codes du bâtiment et réglementations en vigueur.
- Avant l'installation ou la réparation: débranchez l'alimentation électrique; Il incombe à l'installateur des'assurer de la compatibilité électrique, mécanique et thermique.
- La source de lumière LED contenue dans ce luminaire ne doit être remplacée que par Zaneen, ou une personne approuvée par Zaneen.
- Recommandations: Conservez la (les) fiche (s) d'instructions en cas de maintenance et / ou de démontage

Accéder aux fiches techniques détaillées et à la politique de garantie sur la page du produit sur zaneen.com