



## **DIVERSI 40**

Diversi 40 is an extremely efficient compact LED projector, designed for optical excellence and engineered for complete resilience. Diversi 40 offers a choice of four colour temperatures as standard (2200K, 2700K, 3000K and 4000K) and delivers 90 CRI for excellent colour rendering, and with binning-free LEDs carefully selected from two-step MacAdam's ellipses, colour consistency is assured throughout the portfolio. With a deep recess of the in-house designed PCB, Diversi 40 offers excellent glare control.

### **NOTE!**



This fixture is guaranteed only if installed with constant voltage Zaneen drivers.

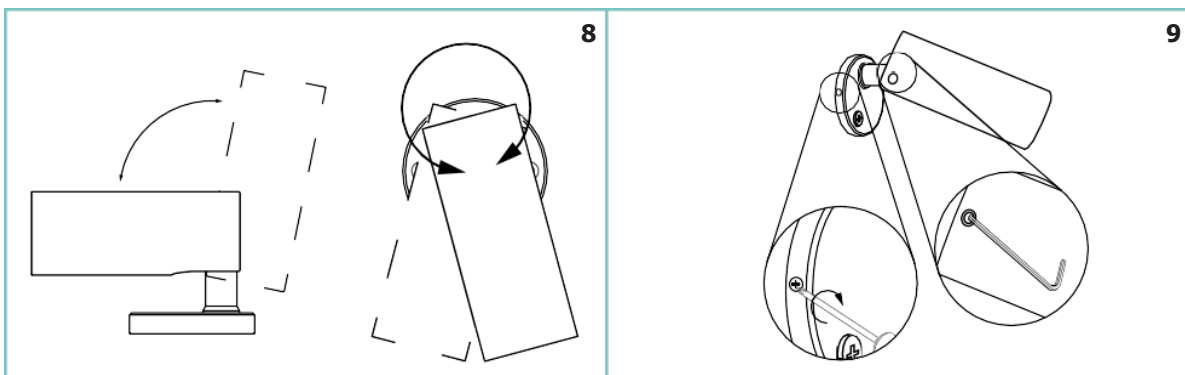
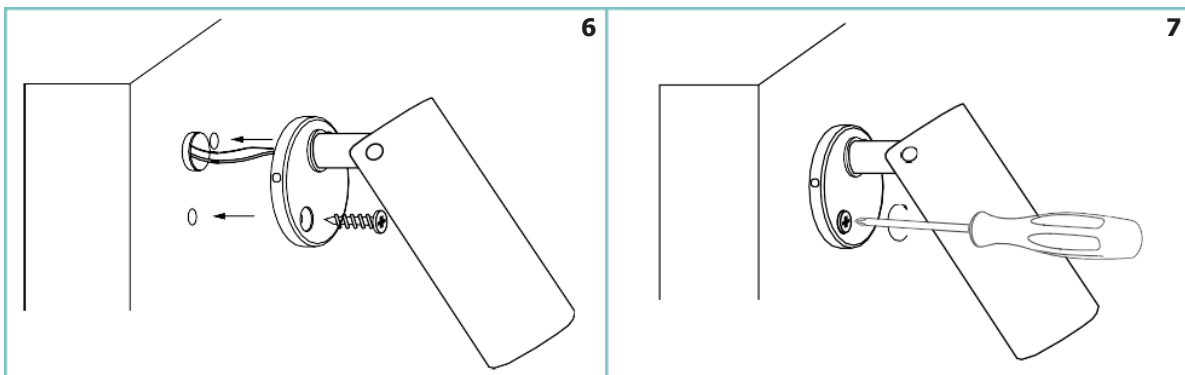
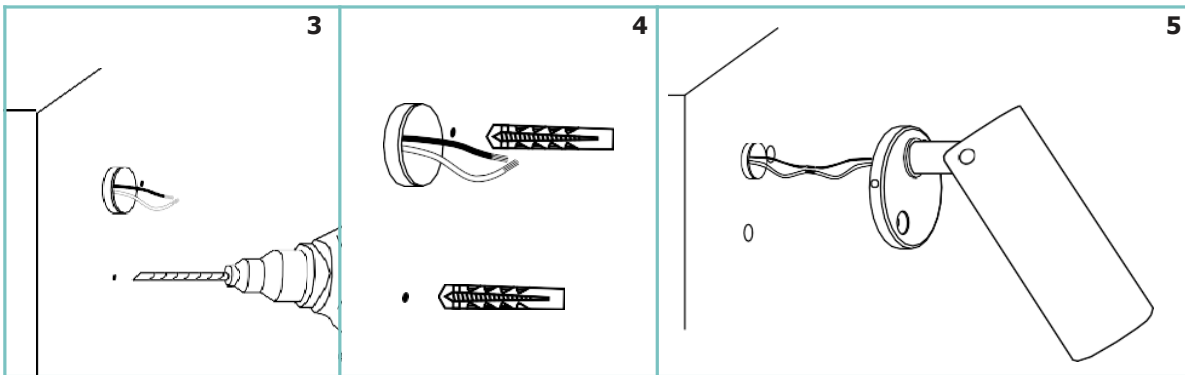
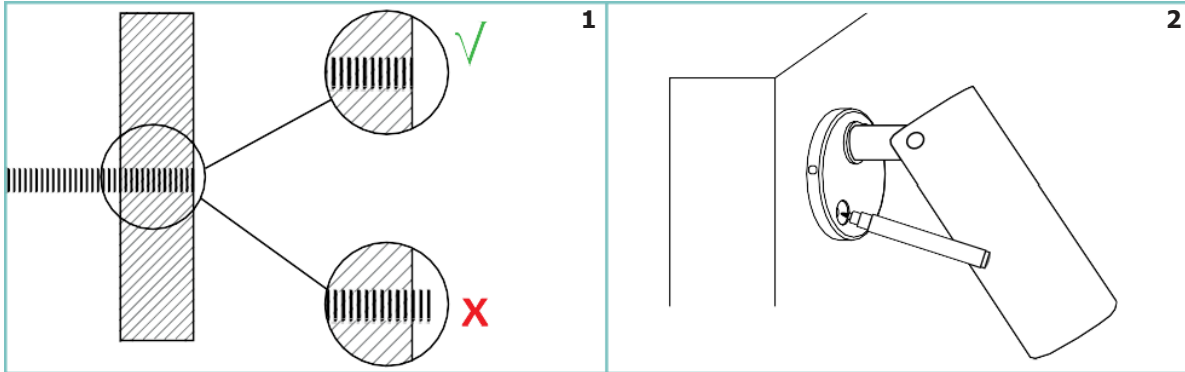

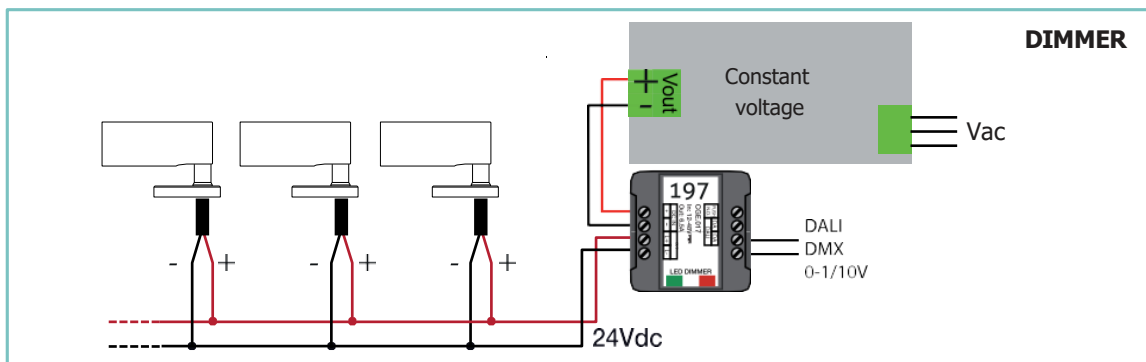
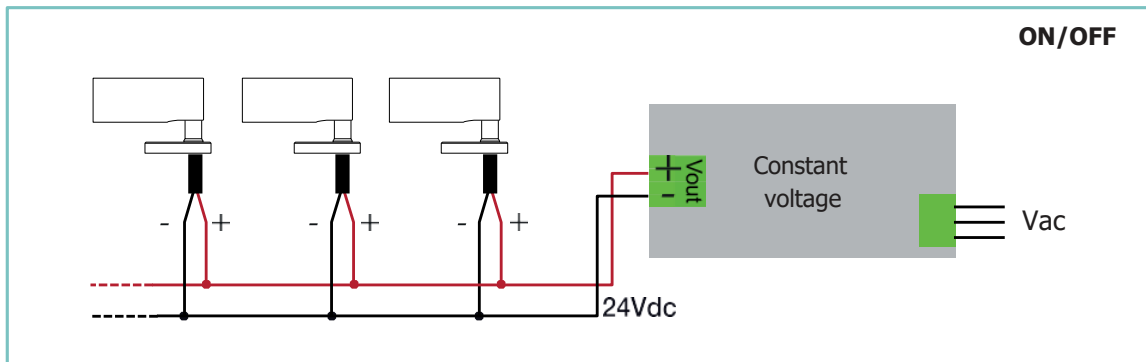
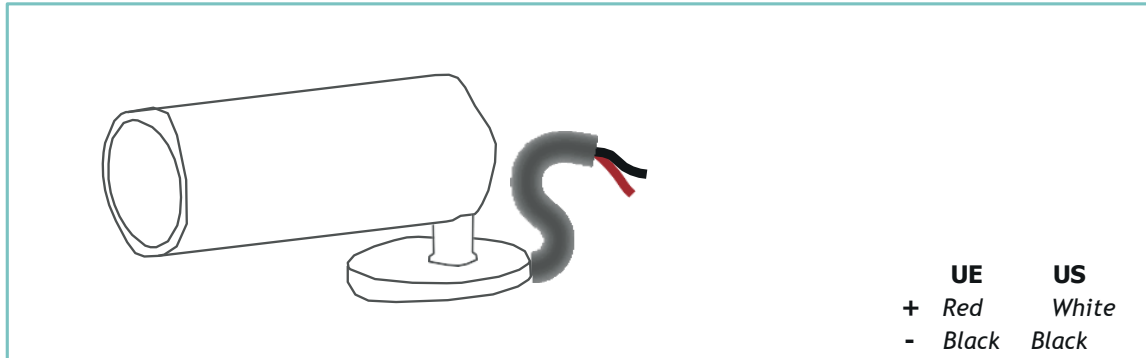

## TECHNICAL DATA

|                              |  |
|------------------------------|--|
| Body:                        | Anodized aluminium 6026 /<br>Machined aged brass           |
| Glass:                       | Extra clear tempered glass 3 mm                            |
| Finishes:                    | Natural anodized /<br>Black anodized /<br>Aged solid brass |
| Installation:                | Surface mounted / Spike / Tree                             |
| Power supply cables:         | 130 cm NS20N PCP 2x0,5 mm2                                 |
| Power supply:                | Constant voltage 24Vdc                                     |
| Power consumption:           | 2,6 Watt / 3,6 Watt  |
| CRI:                         | >90  |
| Bin selection:               | Binning free 2 step MacAdam's                              |
| Lumenoutput (source):        | 210 lm / 283 lm (3000K)                                    |
| Operating temperature:       | -20°C +50°C  |
| IP rating: Insulation class: | IP66<br>Class III  |
| Impact resistance:           | IK07   |
| Weight:                      | 270 g  |
| Optics:                      | 10° / 23° / 43° / 10°x 40° / 40°x10°                       |
| LED colour temperature:      | 2200K / 2700K / 3000K / 4000K                              |
| Lifetime LED:                | 100000 hrs   |

### WARNING!



Do not cover the light fixture, make sure it is guaranteed the cooling of the lamp.

Never connect or disconnect the fixture when the driver is powered.

The safety of the fitting is guaranteed by the correct use of the following instructions. It is therefore necessary to keep them.

When carrying out all assembly, maintenance and fixture replacement operations, make sure that the power is off.

The fitting should be installed by qualified installers to comply with the HD 384 standards.

**IMPORTANT**

Post Sales Support HQ 1-800-388-3382 support@zaneen.com



EN

- Installation and electrification must be carried out by a qualified electrician, only.
- Observe all relevant building codes and regulations.
- Prior to installation or repair: disconnect power; it is the installer's responsibility to ensure for all electrical, mechanical and thermal compatibility.
- The LED light source contained in this fixture shall only be replaced by Zaneen, or a person approved by Zaneen.
- Recommendations: Keep the instruction sheet(s) in the event of maintenance and/or disassembly.

Access detailed specification sheets and the warranty policy on the product page at [zaneen.com](http://zaneen.com).

FR

- L'installation et l'électrification doivent être effectuées uniquement par un électricien qualifié.
- Respectez tous les codes du bâtiment et réglementations en vigueur.
- Avant l'installation ou la réparation: débranchez l'alimentation électrique; Il incombe à l'installateur des'assurer de la compatibilité électrique, mécanique et thermique.
- La source de lumière LED contenue dans ce luminaire ne doit être remplacée que par Zaneen, ou une personne approuvée par Zaneen.
- Recommandations: Conservez la (les) fiche (s) d'instructions en cas de maintenance et / ou de démontage

Accéder aux fiches techniques détaillées et à la politique de garantie sur la page du produit sur [zaneen.com](http://zaneen.com)