

Architectural

# Systems

Lighting Without Limits



# ZANEEN

Overview .....	3
Line Voltage Systems .....	4
2Look4 Collection	
Forties	
Hypro	
Nodo	
Low Voltage Systems .....	20
35 Track	
Clicktrack	
Code System	
G-50 Channel	
Just Black System	
Level	
Minimal track	
Viavai	
Track Lights .....	41
Centriq	
Imagine	
Magiq Wallwash	
Oiko Pro In	
Expert Collaboration .....	51

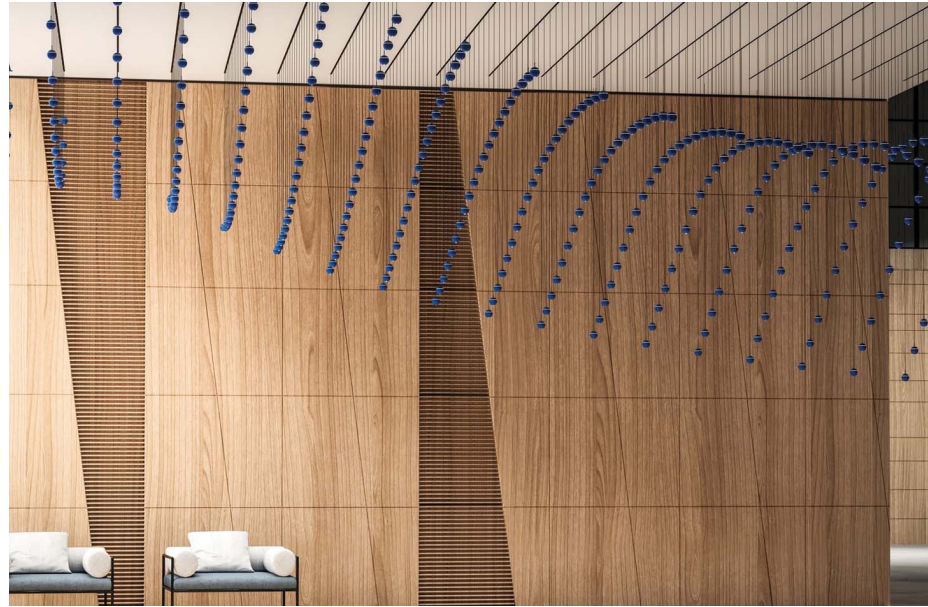
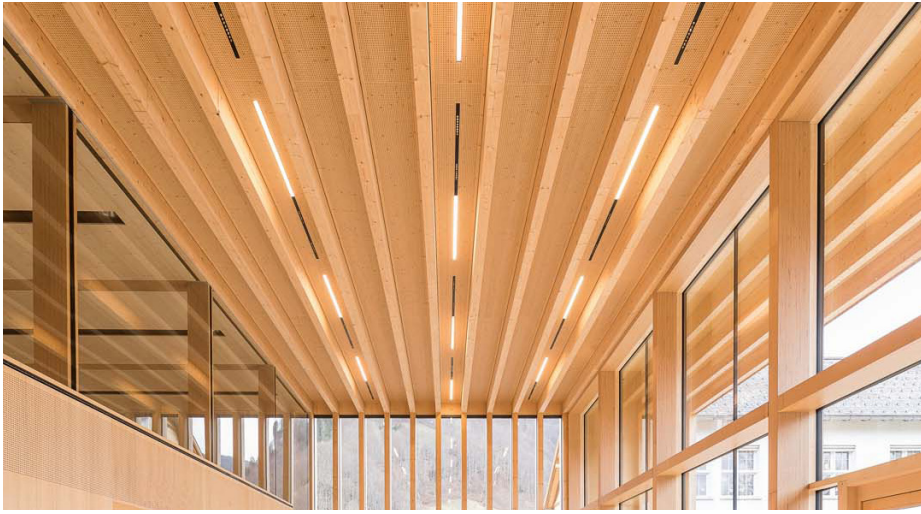

Our architectural track systems merge advanced lighting technology with minimalist design to deliver powerful illumination and flexibility. The range spans from discreet, ultra-low-profile options to bold modular systems, meeting the needs of offices, retail, hospitality, academic environments, and beyond.

These systems allow intuitive installation and seamless integration across walls and ceilings. With a wide variety of inserts, connectors, and controls, designers gain the freedom to shape light with precision, purpose, and beauty.

# Line Voltage Systems

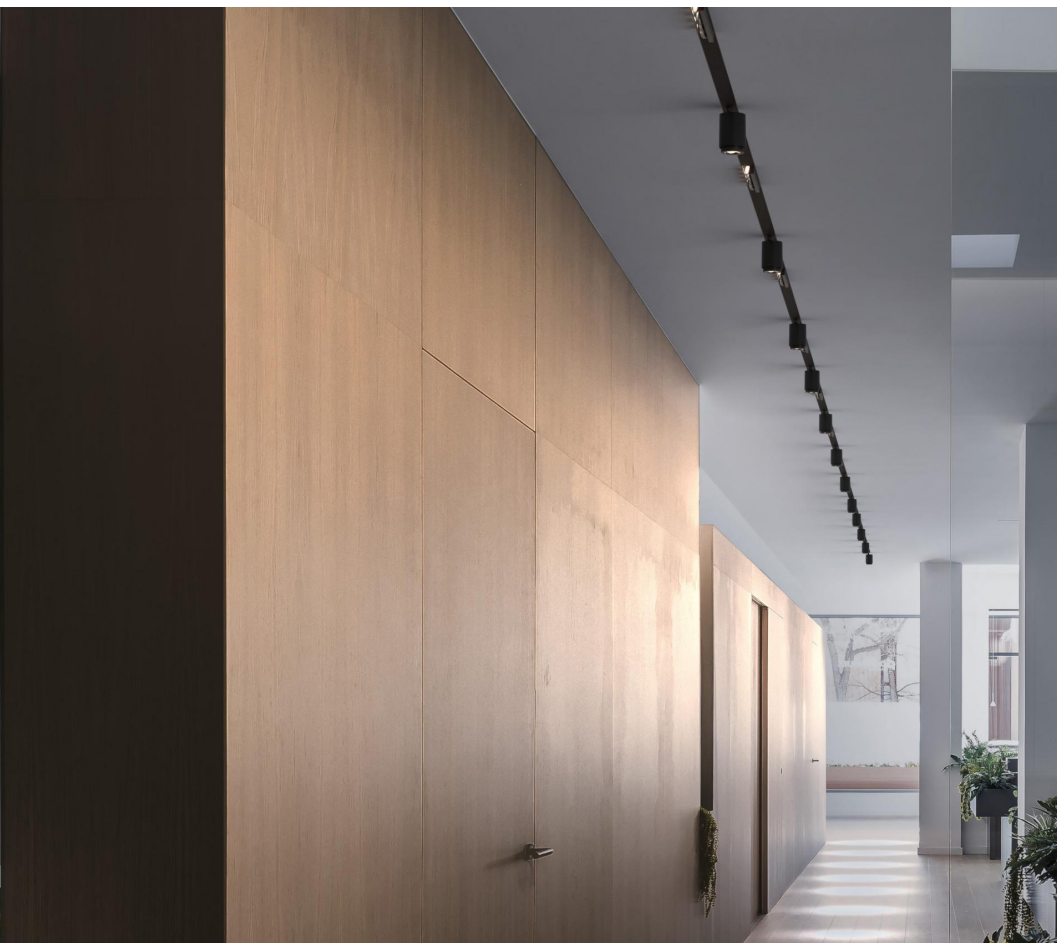

# Line Voltage Systems

Line Voltage provides a straightforward, cost-effective lighting solution for North American projects. Designed for reliability and ease of use, they eliminate unnecessary components while supporting powerful, architectural-grade illumination.

- Operates directly on 120V infrastructure for seamless compatibility
- Integrated drivers and plug-and-play wiring reduce installation complexity
- Supports brighter, higher-output fixtures for general illumination needs
- Low-maintenance design ensures long-term performance and efficiency



## 2Look4

A trimless system that integrates seamlessly into walls and ceilings, delivering architectural-grade lighting with a refined, linear aesthetic. Built for continuous integration, it adapts easily as design needs evolve.

- Tool-free installation for fast setup
- Plug-and-play wiring for easy reconfiguration



# 2Look4 20 Track



Discreet, high-performance lighting through a minimal 20mm opening, ideal for emphasizing architectural lines with outputs up to 2440 lumens.

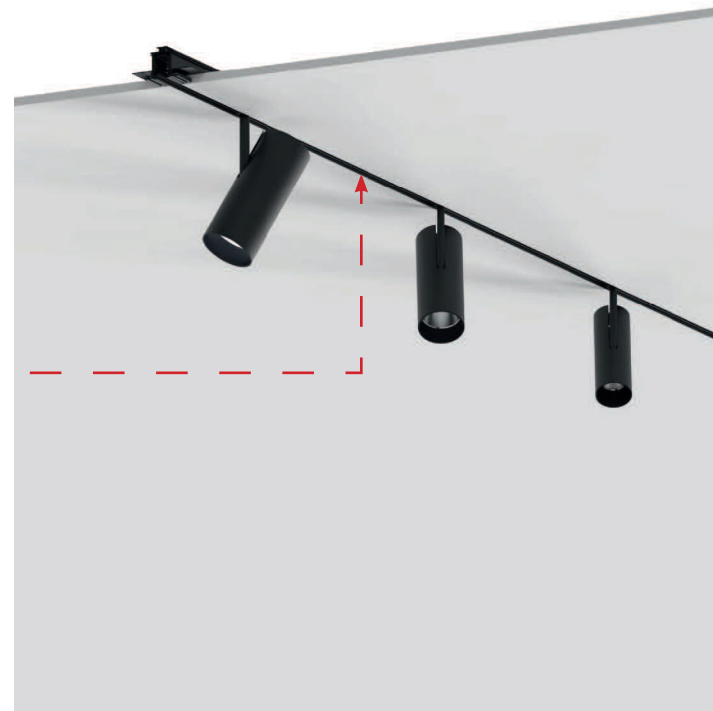
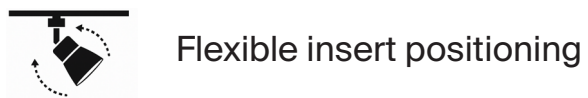
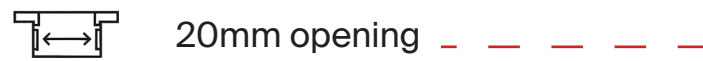

## Inserts



## Imagine



Special 120 V Slim Adapter



# 2Look4 50 Plug



## Inserts



Centriq



Magiq



Magiq Hollow Wallwash



Magiq Micro-Dot



Magiq Wallwash

Provides a 50 mm opening with pivoting modules (2° x 25°) for glare-free light inserts, while high-output wallwash optics make it a versatile system.



2° - 25°

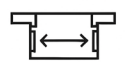

50mm opening



# 2Look4 50 Track

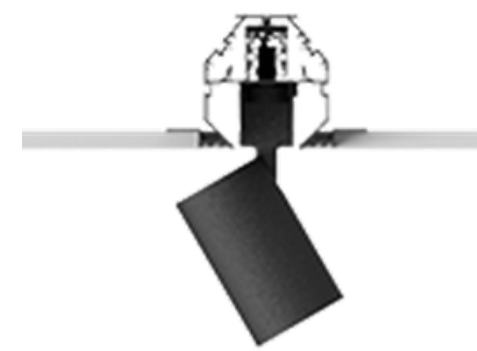

**Flush Housing**

All three spotlight sizes are flush-mounted into the ceiling, creating a sleek, uninterrupted integration with architectural surfaces, ideal for minimalist interiors.

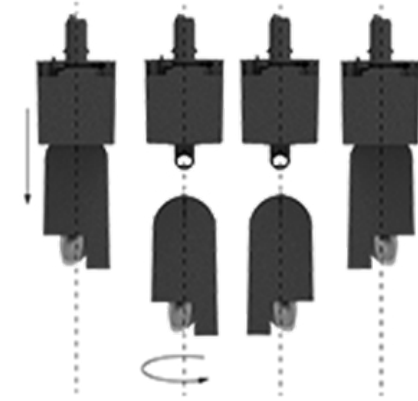

**Wallwasher Dual Adjustment**

The Magiq Plus Wallwasher adjusts vertically in 5° steps up to 15°, ensuring precise alignment and optimal wall illumination even with ceiling irregularities.

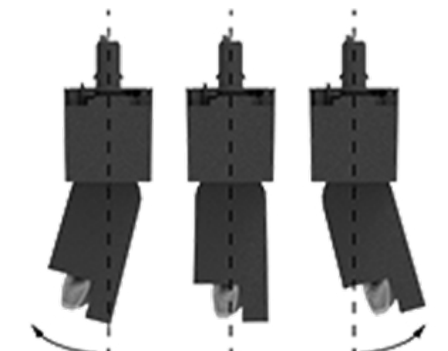

**Wallwasher 180° Rotation System**

A built-in unlocking system enables 180° rotation and secure locking, giving installers flexibility to position the spotlight on either side of a 3-phase track.

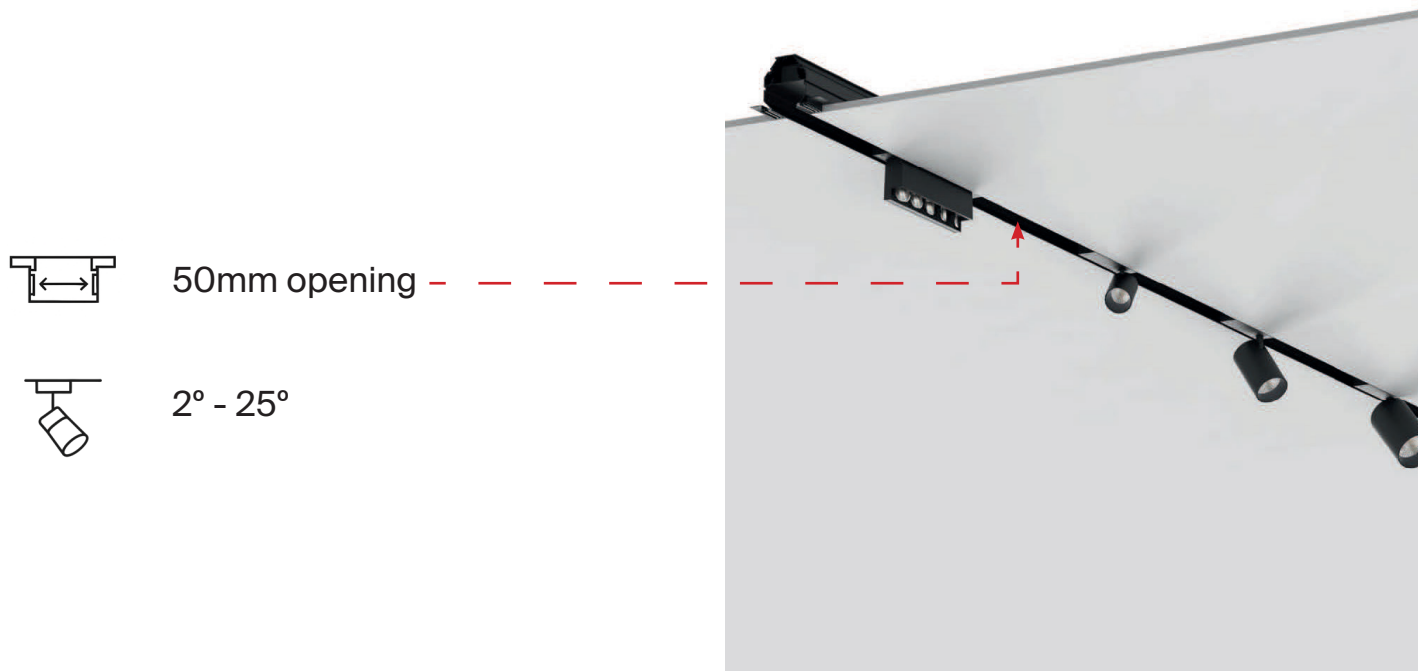

 50mm opening

 2° - 25°

## Inserts



Centriq In



Magic Plus Wallwash



Oiko Pro In

# 2Look4 80



The custom options include a recessed version of the 130 and 80, which has now become possible. In addition, the ability to incorporate Centriq, Oiko, and Imagine Spots into the system offers greater flexibility

Whether used for ambient, task, or feature lighting, 2Look4 delivers a unified, design-forward system that supports creativity without compromise.

## Inserts

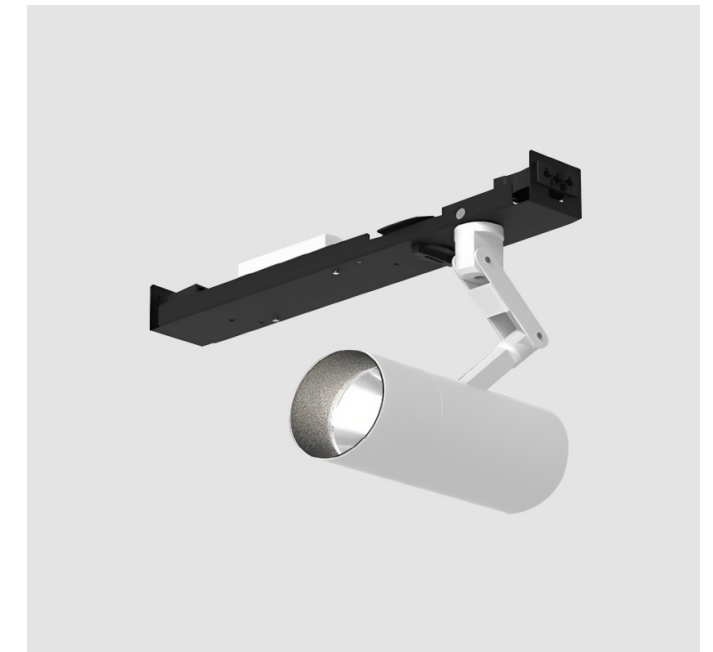

Imagine

Balances form and flexibility with adjustable spots, wallwash options, and optional cove channels—mirroring the modularity of the 130 series but in a compact 80mm profile.

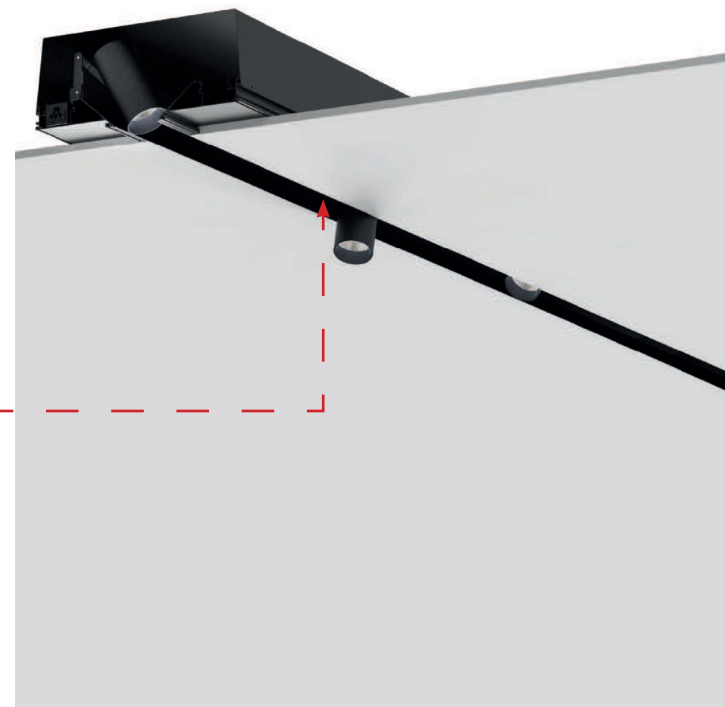

 80mm opening

 Flexible insert positioning

 Cove light option

# 2Look4 130



## Inserts

Offers a 130mm opening with flexible insert positioning, adjustable optics, and the option for cove lighting, available with or without a framed housing.

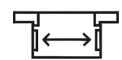

130mm opening



Flexible insert positioning

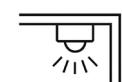

Cove light option



Optional Backlight



Imagine

# 2Look4 160



Delivers total design freedom by integrating Bioniq adjustable downlights within a sleek 160 mm profile. This allows precise placement of luminaires exactly where needed, supporting both focused task lighting and ambient effects with architectural elegance.

Its ability to host custom spot modules like Invader, Oiko, and Magiq Pro enables a seamless mix of general, accent, and wallwash lighting within a continuous system.

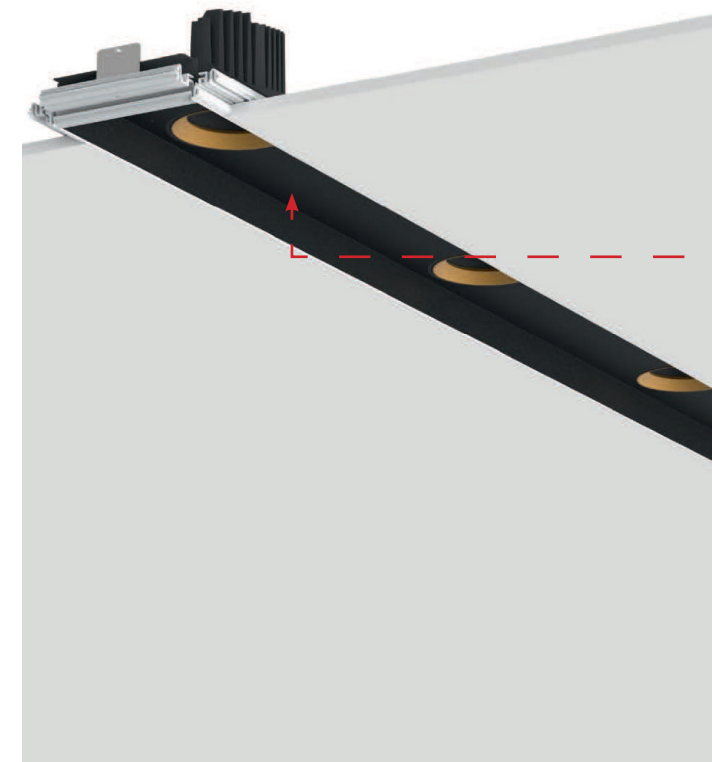

Features seamless integration of Bioniq adjustable downlights within a 160mm profile, allowing total freedom in luminaire placement.

- 160mm opening



Bioniq

# Forties

A 45mm modular system that brings innovation and exceptional flexibility to high-performance lighting. With curves, linear profiles, and custom inserts, it empowers designers to create unique solutions that adapt effortlessly to any space, while remaining sleek, versatile, and cost-efficient.

- Optics options: opal, microprism, or glare-reducing
- Wallwash and high-lumen spotlights with tunable white
- Surface-mounted or suspended versions



# Forties

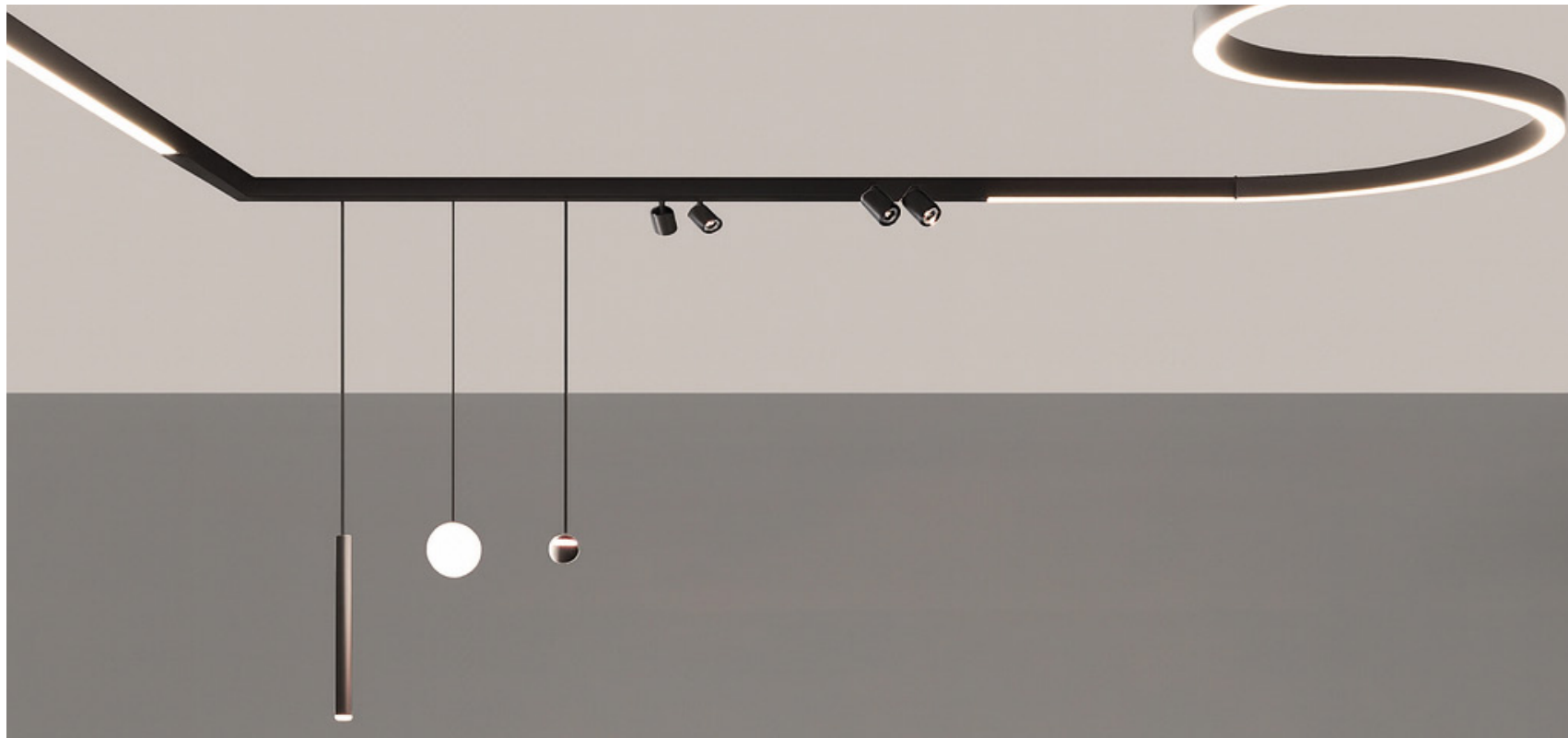

## Configurations

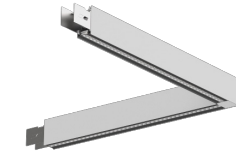

L - Connector

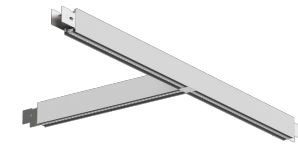

T - Connector

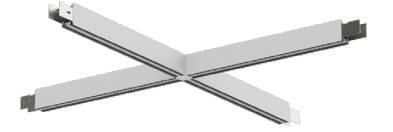

X - Connector

## Inserts

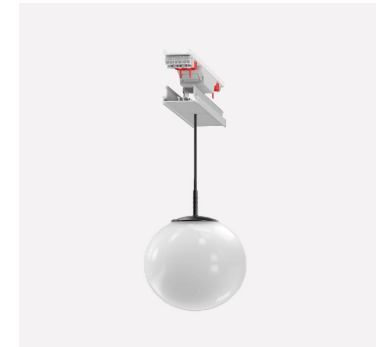

Bilo

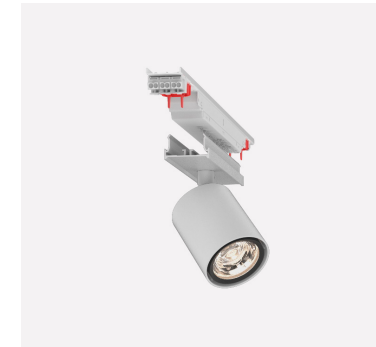

Centriq



Hangover



Imagine Micro

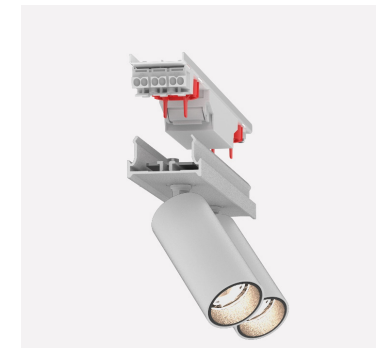

Imagine Micro Double

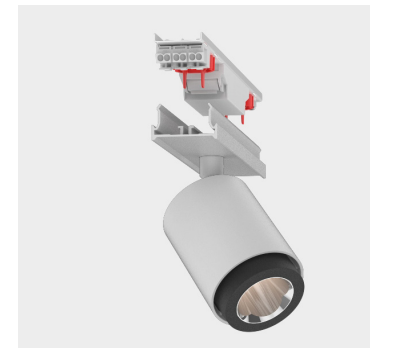

Oiko Pro



Oiko Pro Double

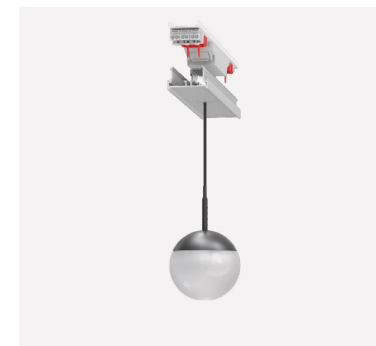

Snooker Glass

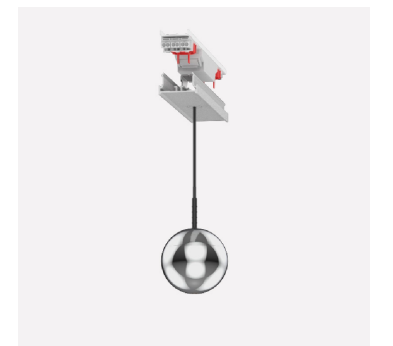

Snooker Metal

# Hypro

A sleek 40mm track system that redefines spatial lighting, enabling continuous lines of light across ceilings, walls, and transitions. With versatile connectors and a clean architectural aesthetic, it offers unmatched design freedom.

- High-output, low-glare illumination for both ambient and task lighting
- Option to integrate acoustic panels for combined light and sound control



# Hypro

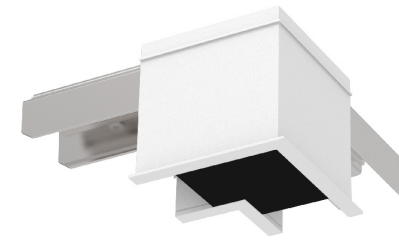

L - Connector

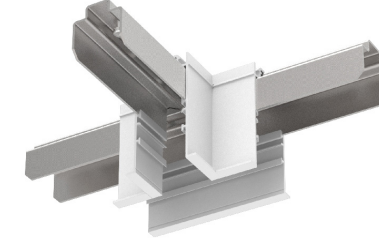

T - Connector

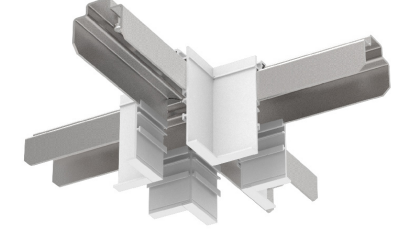

X - Connector

## Configurations



Recessed



Surface



Suspension



The Rico reflector is a standout feature of the Hypro system, an advanced linear LED insert that delivers efficient task lighting with reduced glare, improving visual comfort and overall performance.

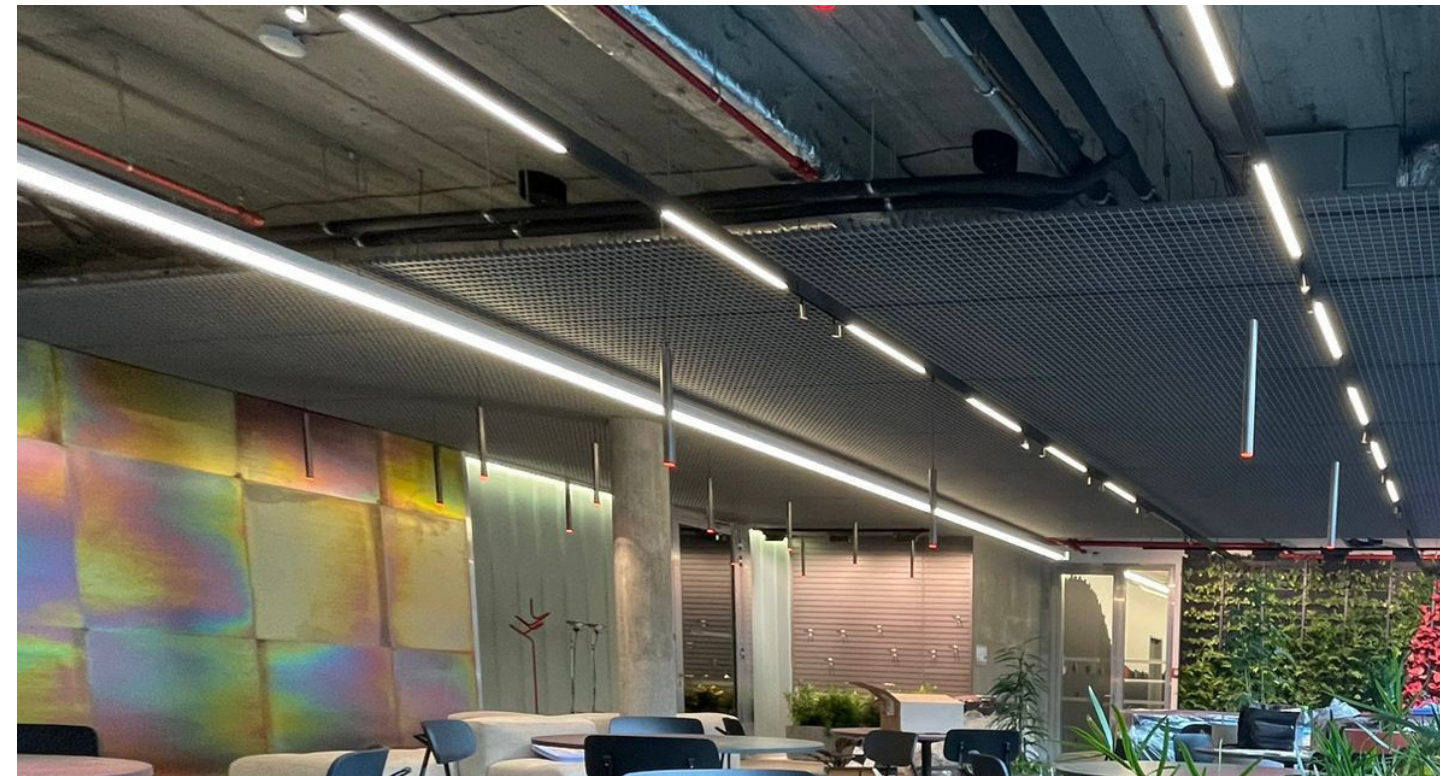

# Hypro



## Inserts



Centriq in Flex

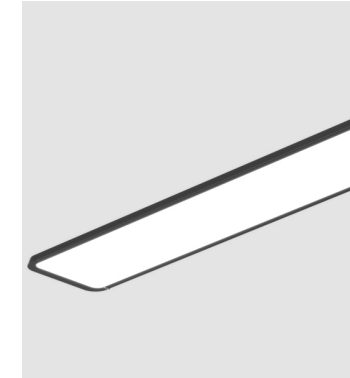

Hadi Surface

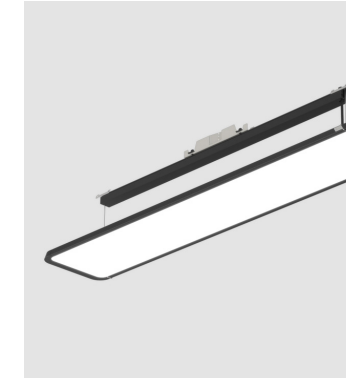

Hadi Suspension

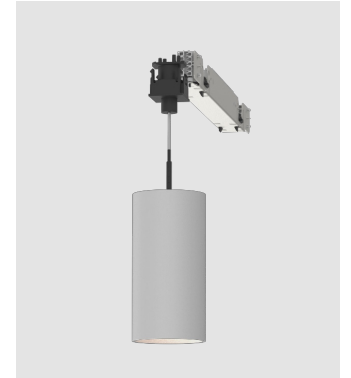

Hangover



Magiq



Magiq Hollow  
Wallwash



Magiq Wallwash



Oiko Pro In



Sign Diva Tube



Snooker Glass

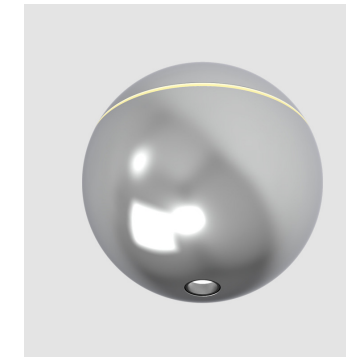

Snooker Metal

# Nodo

A flexible track system designed for spaces with limited power access or architectural constraints, such as exposed brick. Perfect for retrofit projects, it eliminates invasive electrical work, reduces installation costs, and enhances long-term design flexibility.

- Slim profile with movable sockets, USB ports, and spotlights
- Three-circuit back-lit track supports powered and non-electrified elements
- Smart connectors and 90° joints enable versatile configurations



# Nodo

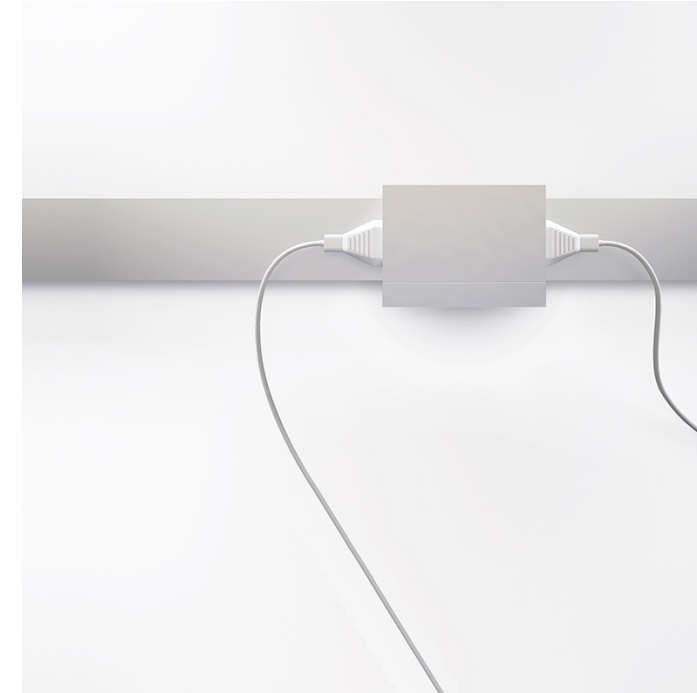

Nodo Box

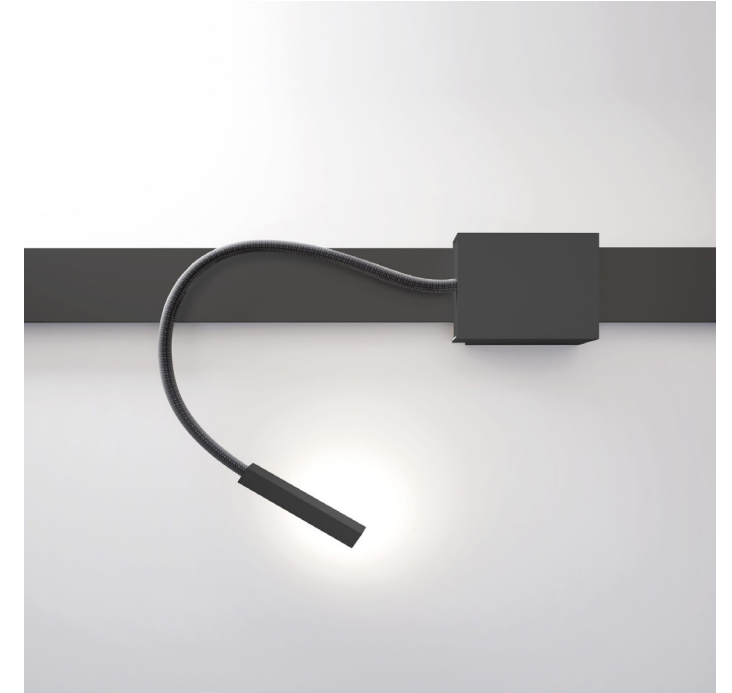

Nodo Lights - Nuo



Nodo - Zoom Adjustable Spot



Nodo - Bob - Track Spotlight



Nodo - Shelf Accessory



Nodo - Paper Towel Holder Accessory

# Low Voltage Systems

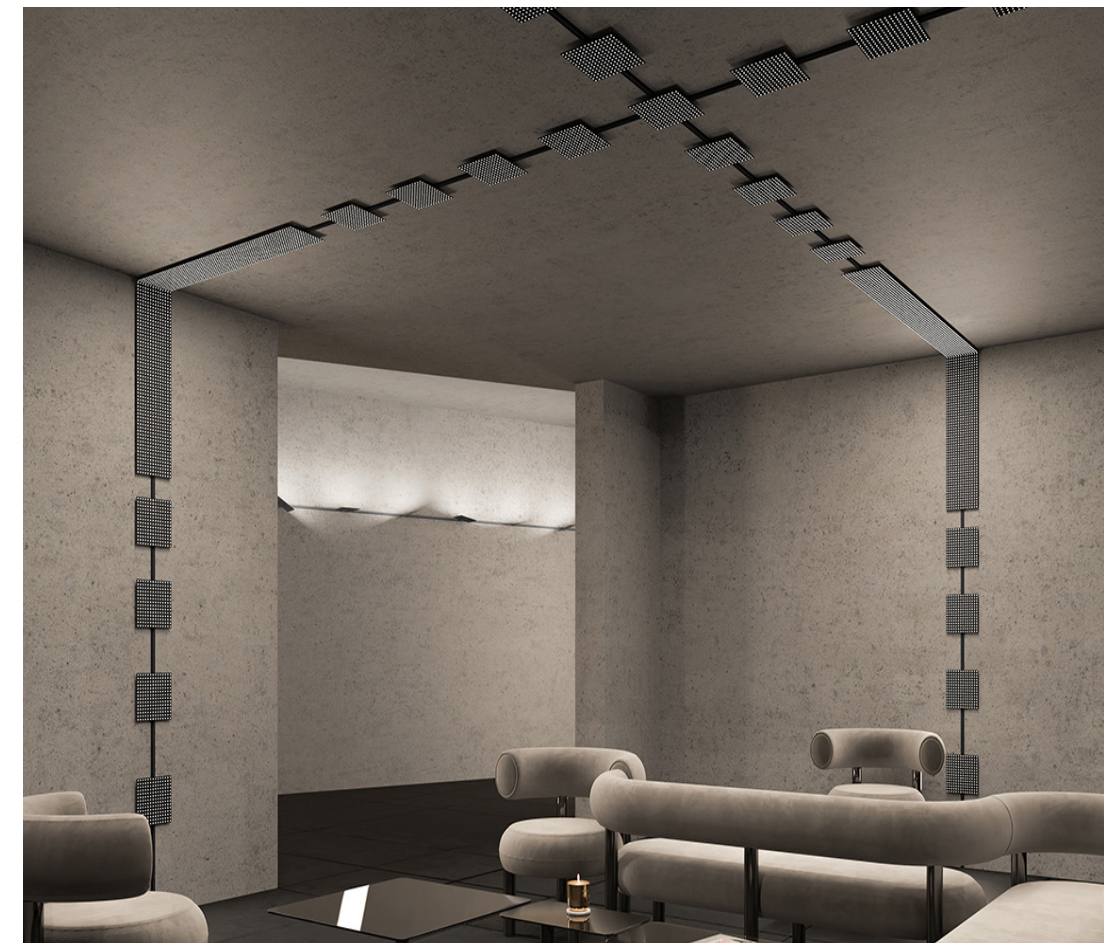

# Low Voltage Systems

These systems (24V or 48V) deliver efficiency, safety, and precision by stepping down 120V power through a remote driver. This enables ultra-compact, discreet luminaires that integrate seamlessly into architectural details while providing highly controlled, task-oriented illumination.

- Reduced voltage improves safety and enables slimmer profiles
- Longer runs and greater design flexibility
- Clean lines, minimal aesthetics, and fully customized effects



## 35 Track

A minimalistic 35mm cylindrical system that combines diffused uplight and focused downlight in a single modular form. With integrated 120° diffusion and support for high-performance inserts, it delivers an elegant, unified lighting solution.

- Modular connection system
- Works standalone or seamlessly with 35 Linear
- 48V compatible for greater flexibility and efficiency



# 35 Track



Freely positionable inserts, including spotlights up to 2000 lumens, offer precise light placement and full flexibility for layered lighting in spaces that demand both ambiance and focus.

## Inserts

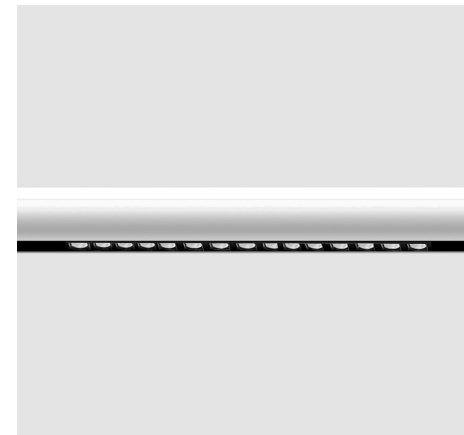

35 Track - Miniroller



35 Track - Miniroller Short



35 Track - Miniroller Long

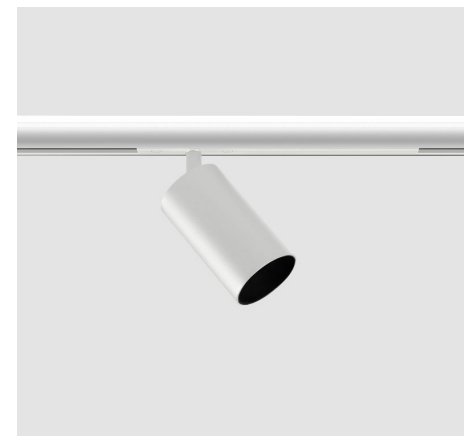

35 Track - Microperfetto



35 Track - Nanoperfetto



35 Track Nanoperfetto -  
Suspension



# Clicktrack

Offering unmatched speed and flexibility from installation to future reconfiguration, this tool-free, click-in system lets lighting inserts be mounted, repositioned, or replaced in seconds. Clicktrack combines design freedom with effortless usability to adapt to any project need.

- Blend of ambient and accent lighting
- Adjustable pendant cables to fine-tune lengths on-site
- Three distinct subseries to suit varying design intents



# Clicktrack 25



### Easy Mounting

Spots click into the track without tools; the pendulum cable is adjustable in length.

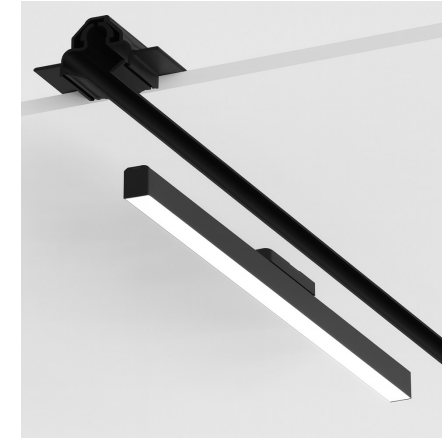

### Hybrid Solution

A variety of inserts, both diffused and targeted, allow for diverse design options.



### Mix & Match

Snooker and Hangover plug inserts can also be combined with articulated spotlights.

Clicktrack 25 features a slender 25mm opening ideal for decorative inserts and concealed spotlights, making it perfect for refined, minimalist applications.

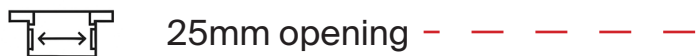

### Different Types of Spots

Adjustable spotlights available in three sizes (Ø 30-40-55 mm), with multiple lenses and lumen packages.

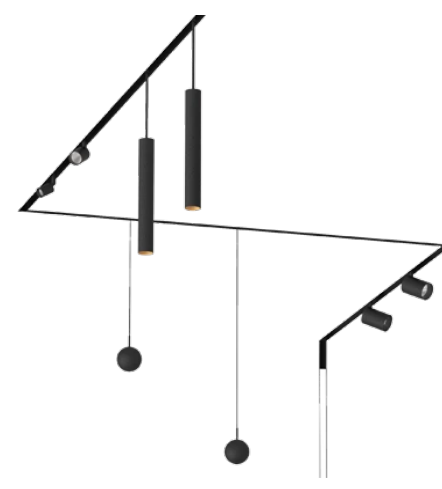

### Versatile Lighting Options

Compatible with inserts from subtle downlights to decorative elements, delivering functional and aesthetic effects.

### Couplers

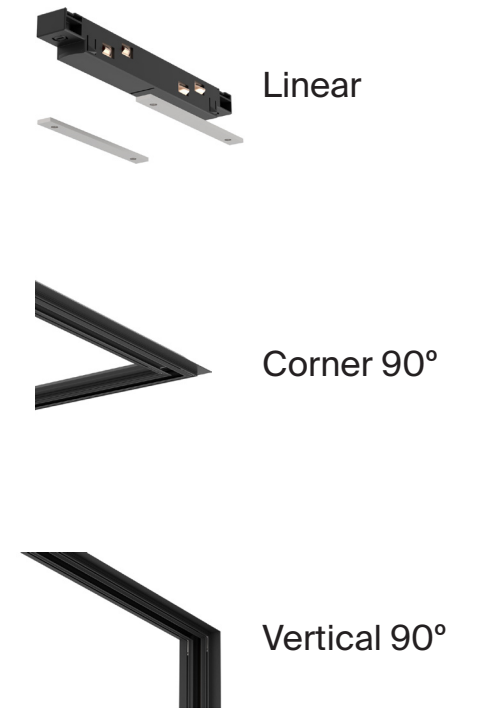

# Clicktrack 30



### Easy Mounting

Spots click into the track without tools; the pendulum cable is adjustable in length.



### DALI Powerline Communication

Remote power line control enables full DALI management of individual luminaires via DC power lines.

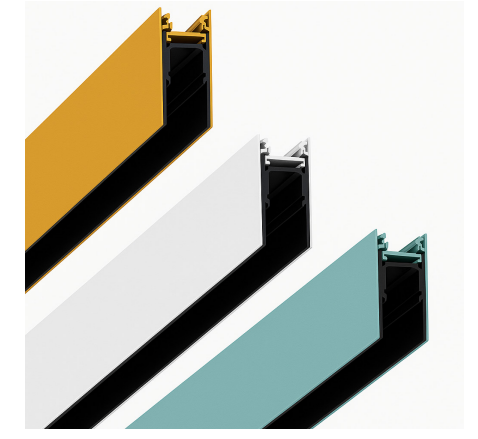

### Bi-Colored 48V Track

Clicktrack 30 is black inside and available in over 20 exterior colors to match any design concept.



Sleek 30 mm profile with refined finishes, available in surface or suspended versions—offering versatile configurations to suit any interior design.

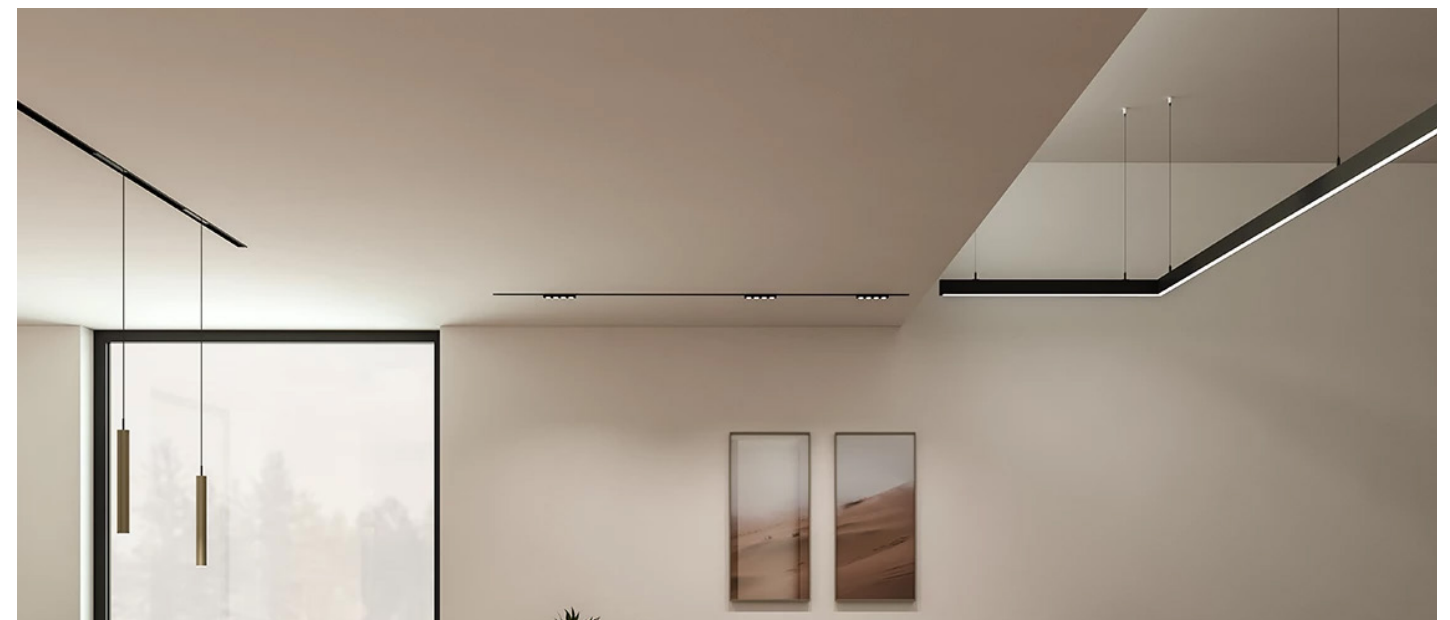

# Clicktrack 50

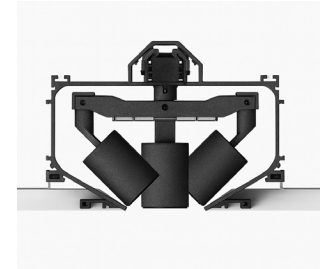

### Full Adjustability

A multi-axis system enables full adjustment of hidden, fully integrated spots.



### Easy Mounting

Spots click into the track without tools; the pendulum cable is adjustable in length.



### Integrated Hinge

Minimalist design with efficient cooling and an integrated hinge for precise adjustment.



### Mix & Match

The snoker and hangover plug inserts can also be used in addition to the articulated spotlights.

50 mm profile with concealed spotlights offers a sleek, integrated look—a compact alternative to 2Look4 80 for clean, low-voltage applications.

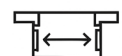

50mm opening

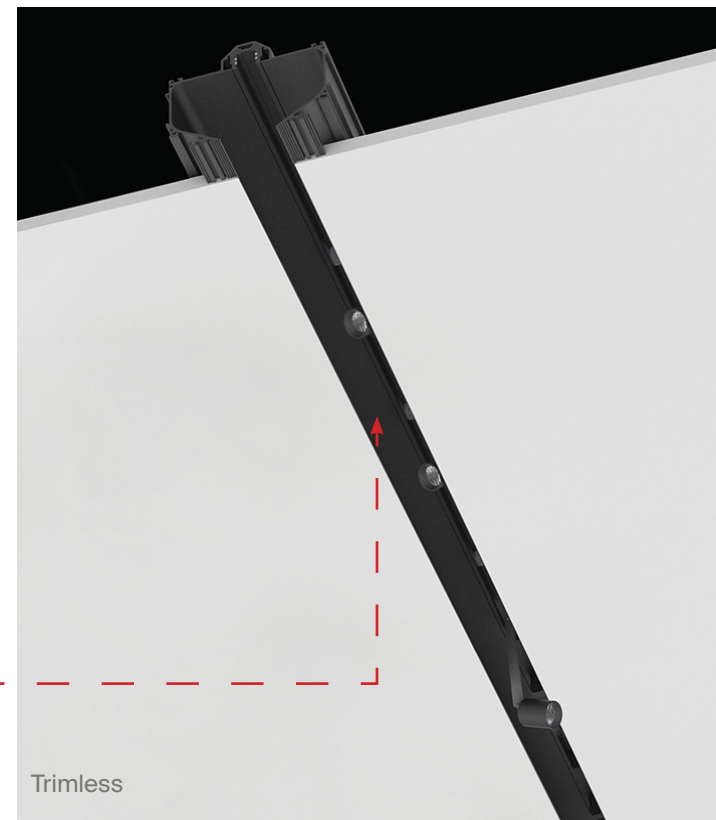

### Inserts

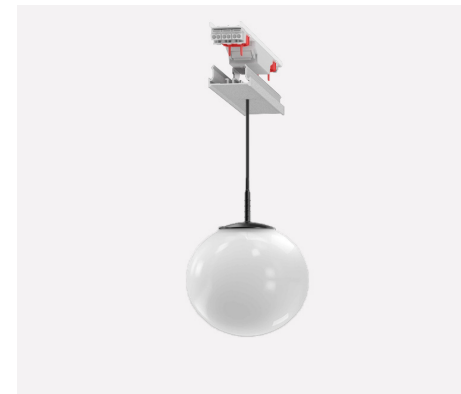

Bilo



Centriq



Hangover



LEDline



Magiq

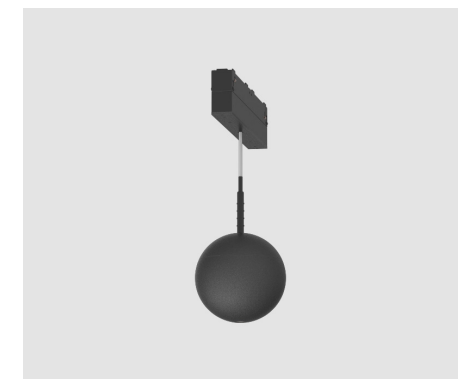

Snoker

# Code System

With a minimal 19 mm profile and modular round/square geometry, Code System enables creative, high-performance lighting layouts, from clean lines to bold architectural compositions.

- Energy-efficient LED technology ensures long-term sustainability
- Individual control of each luminaire allows dynamic, tailored lighting
- Flexible configuration options for walls or ceilings with seamless integration



# Code System

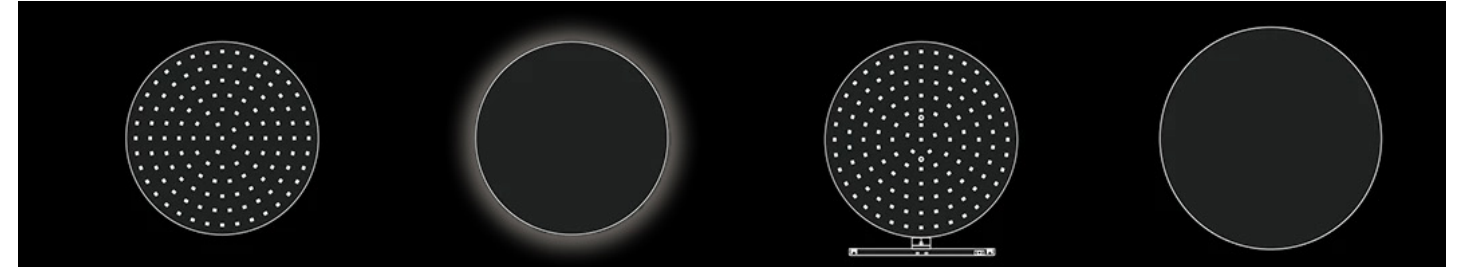

Dot Direct

Dot Indirect

Dot Standing

Dot Power

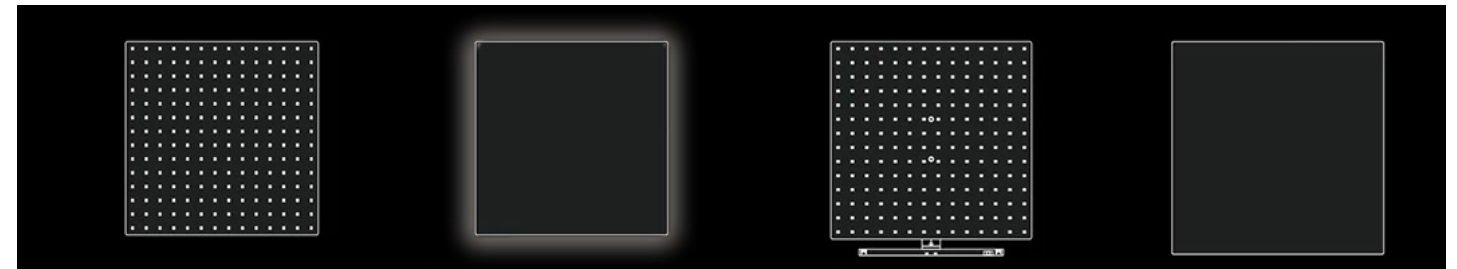

Grid Direct

Grid Indirect

Grid Standing

Grid Power

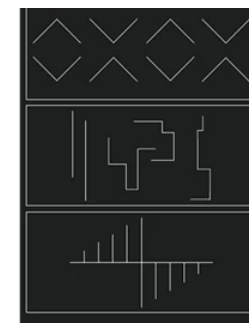

Draw your shape with  
Minimal Track

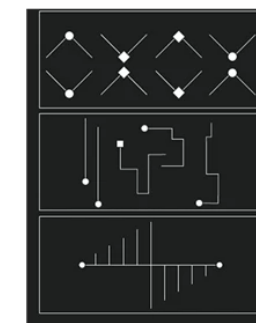

Define your power  
requirements

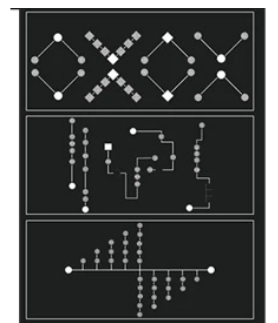

Design your  
Code System

## Inserts



Dash

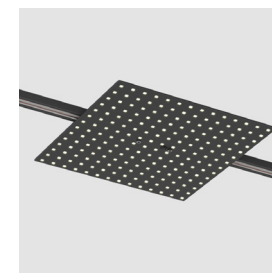

Grid



Dot

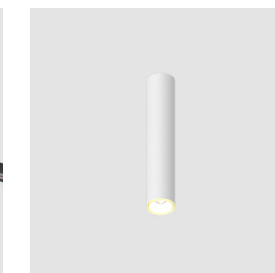

Hangover



Imagine Micro

## G-50 Channel

An innovative system engineered for ultimate flexibility in pendant lighting. Seamlessly compatible with the Gravity Lift, it allows effortless adjustment of suspension heights while maintaining precision and ease of use.

- Up to 1.5 m of continuous adjustability, plus an optional 3.5 m extension for greater reach
- Audible click every 10 cm ensures precise, repeatable alignment along the track
- Compatible with Snooker, Hangover, and Bilo pendants



# G-50 Channel

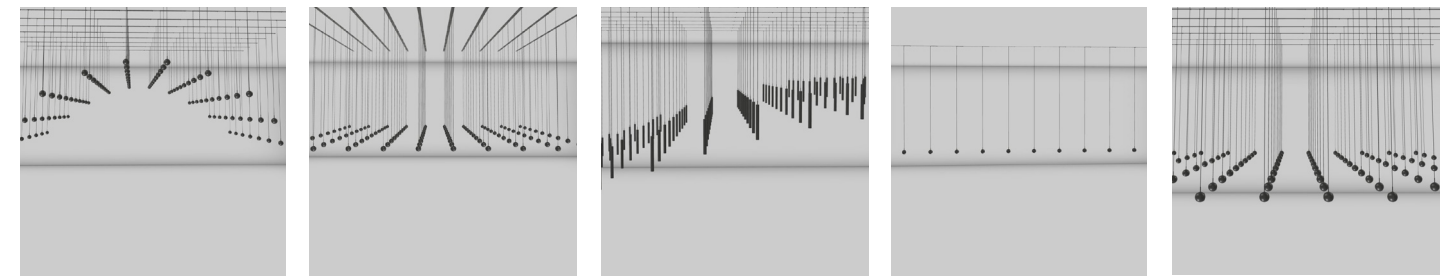

Arch      Default      Half Arch      Line      Plane

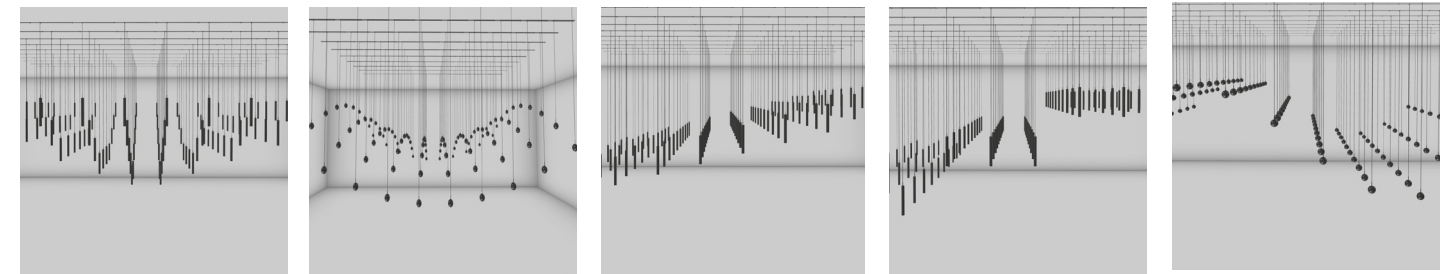

Pyramid      Saddle      Slope      Steps      Wave

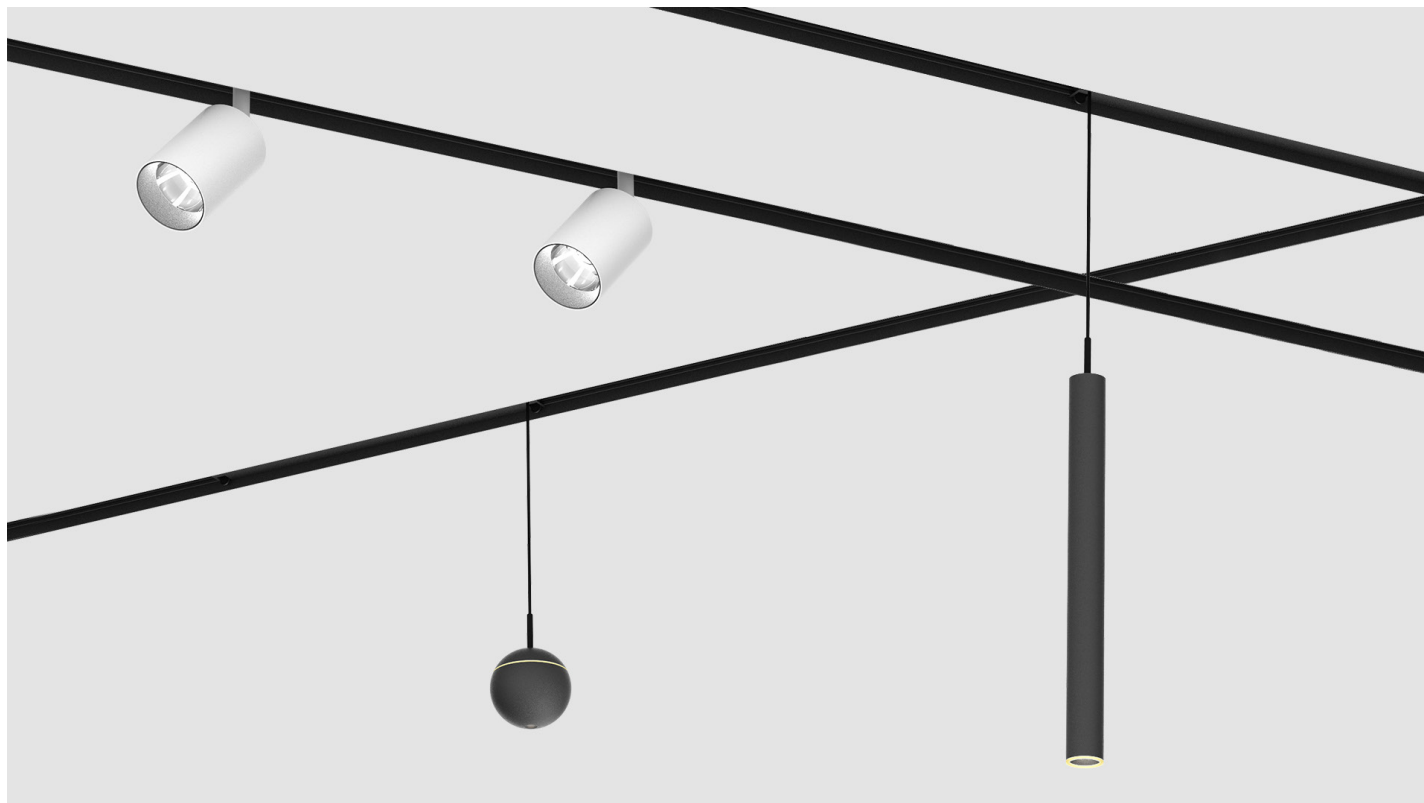

## Inserts



Bilo      Centriq      Hangover      Snooker

## Just Black System

A sleek 5 mm wide black track that adapts to any surface and style, trimless, recessed, surface-mounted, or suspended. Operating on 24V, it features a magnetic insert system for quick, tool-free installation and reconfiguration.

- Bendable flexline LEDs create continuous curves with a minimum 150 mm radius and up to 2000 mm arch length
- Variety of inserts enables both functional and decorative lighting, while ensuring cost-effectiveness



# Just Black System

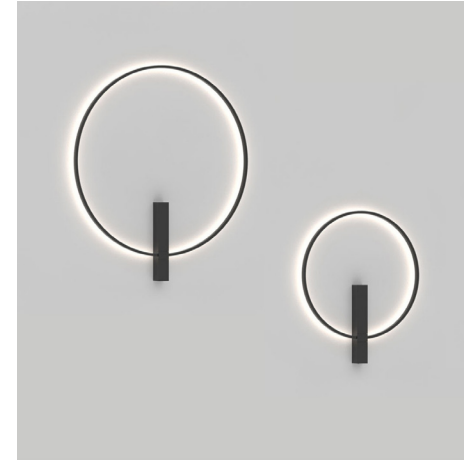
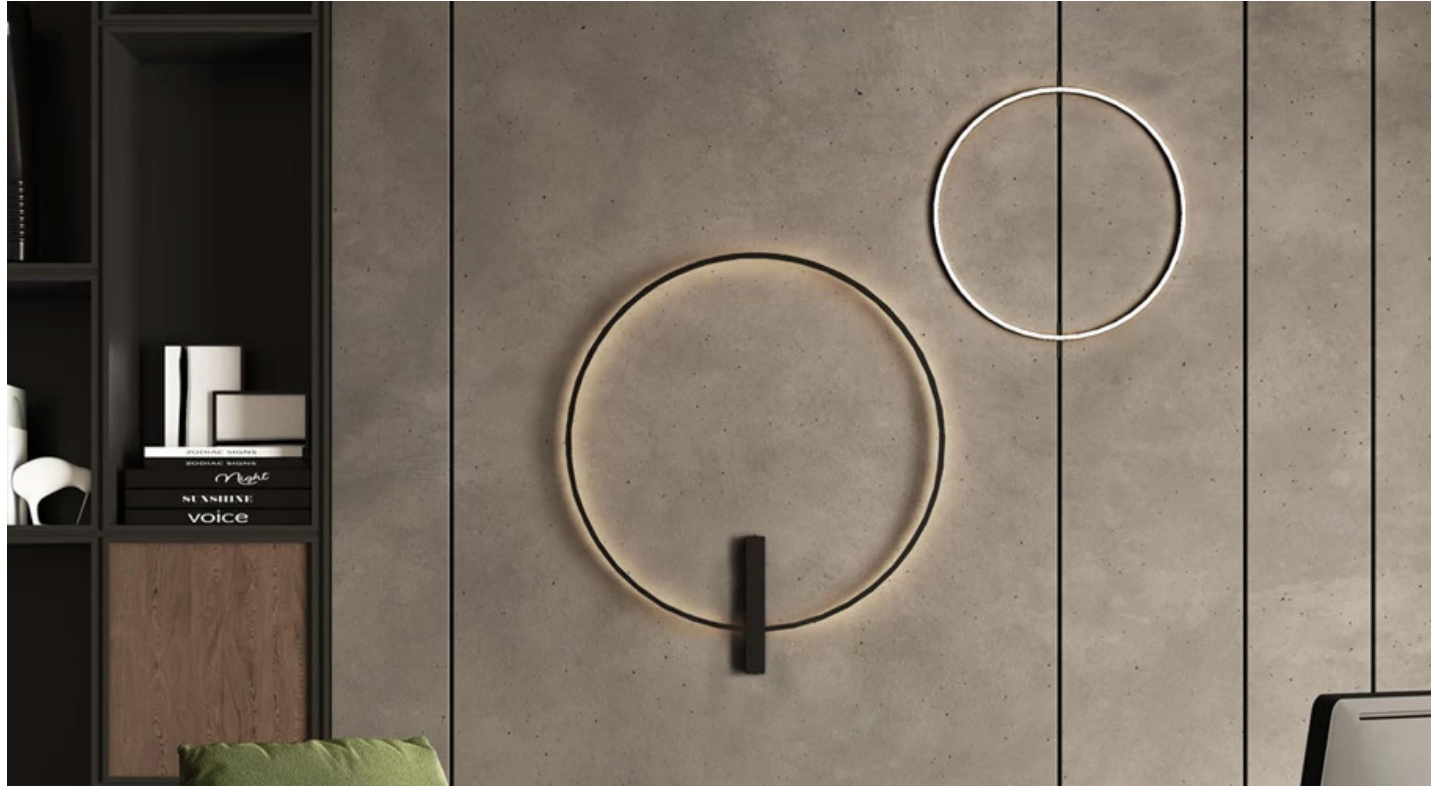

Just Black Halo



Just Black Line



Just Black Lines

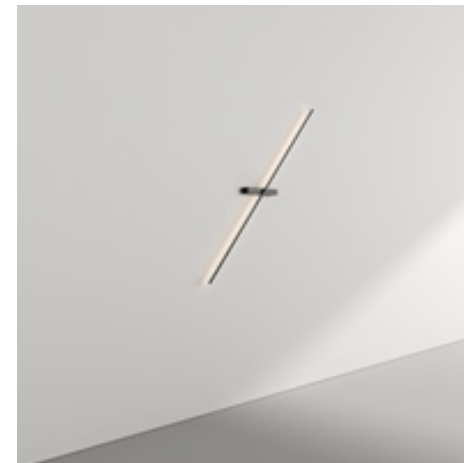

Just Black Line Adjustable



Just Black Line Double



Just Black Surface

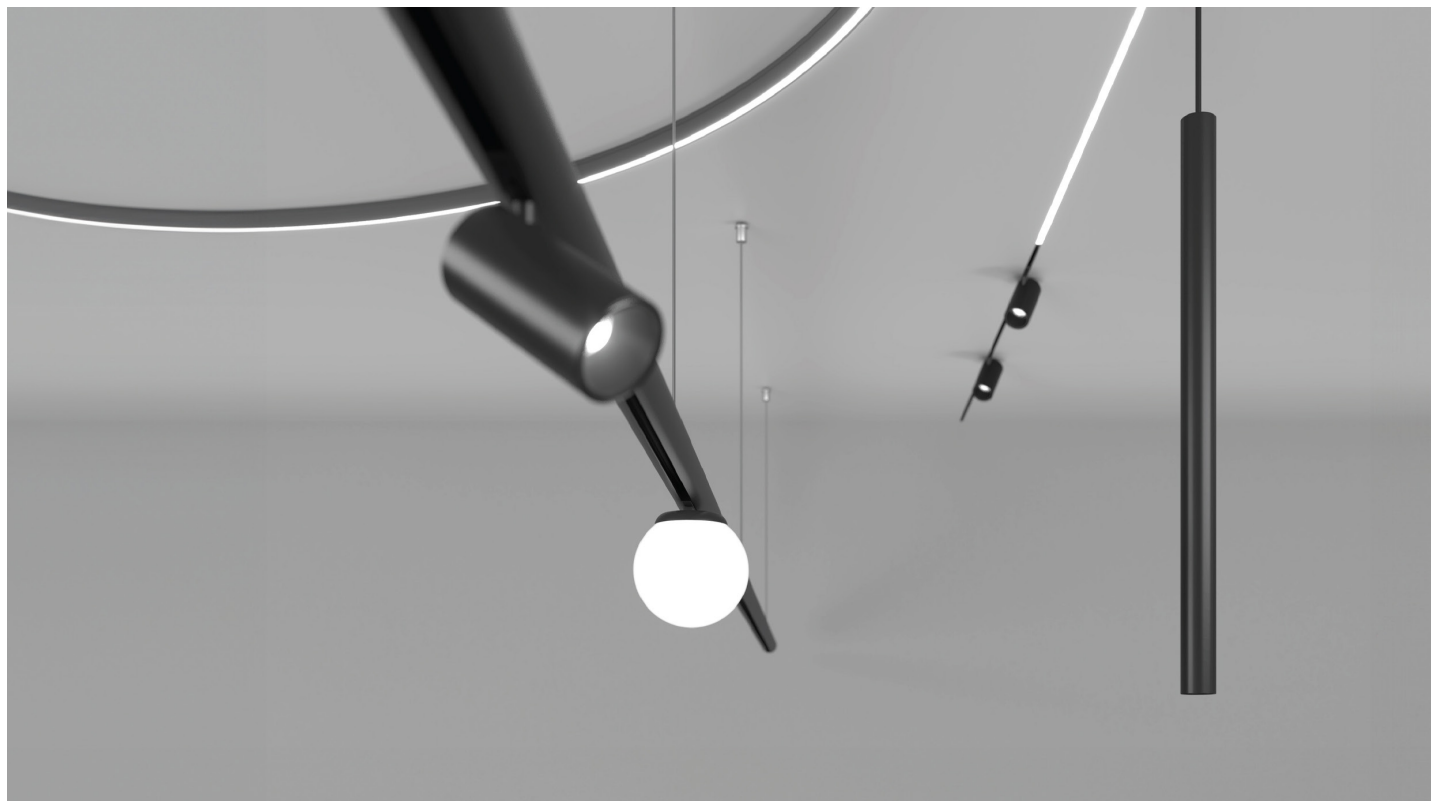

Just Black Suspension



Just Black Tracks

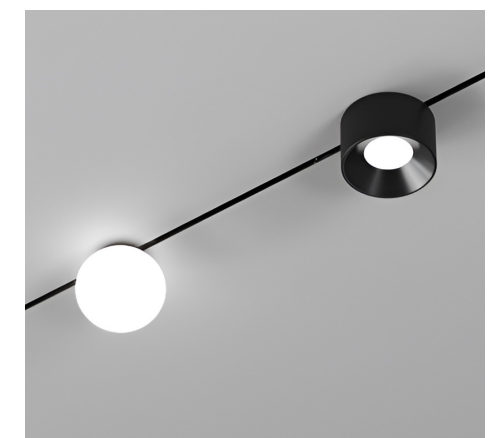

Just Black Trimless

# Just Black System

## Inserts

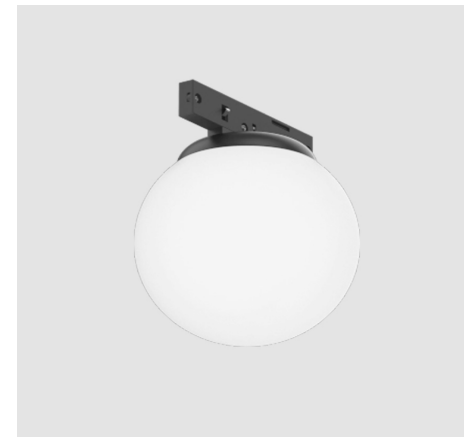
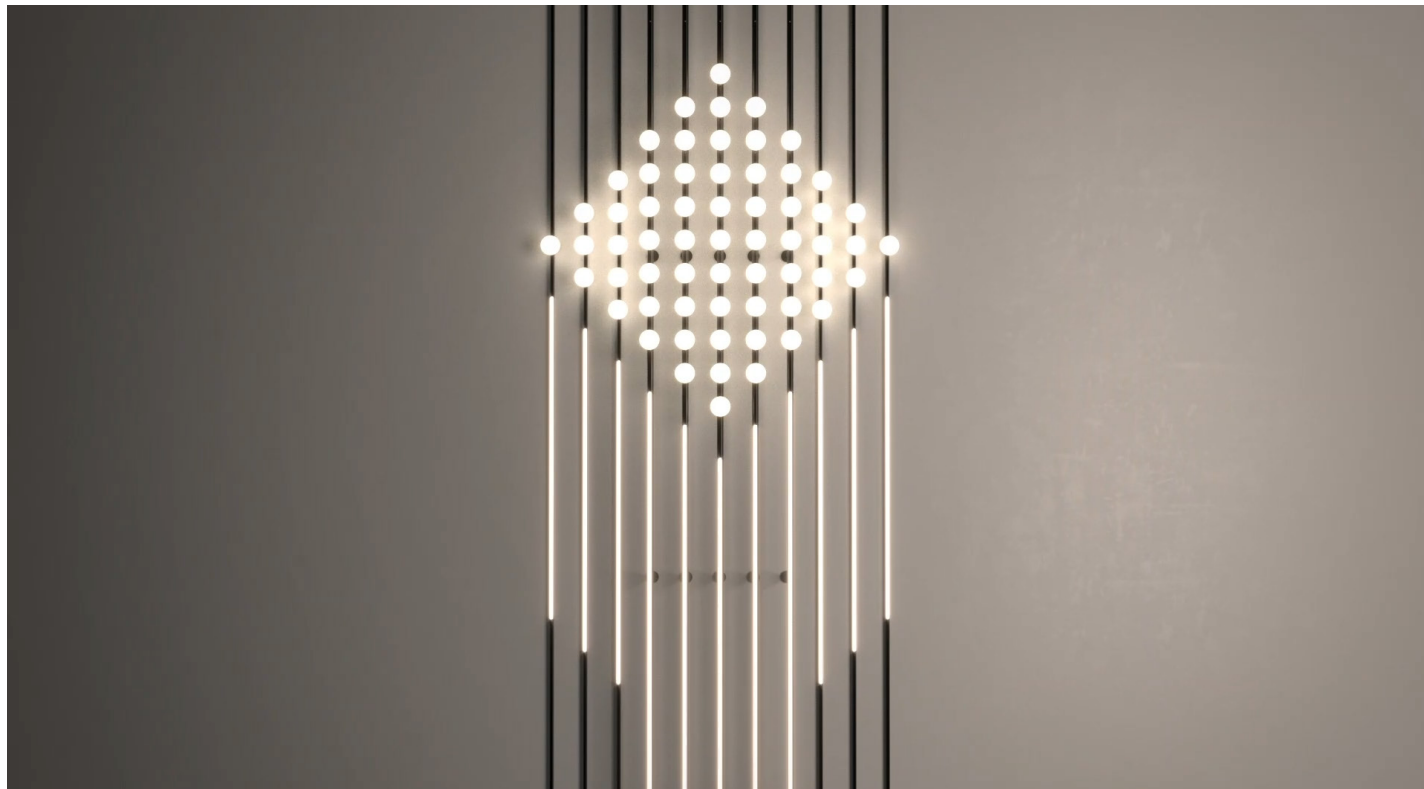

Bilo

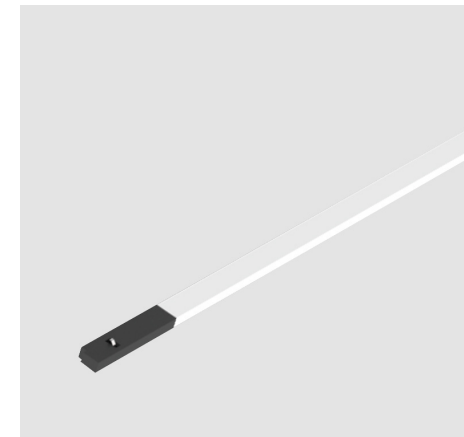

Flexline



Flute



Hangover

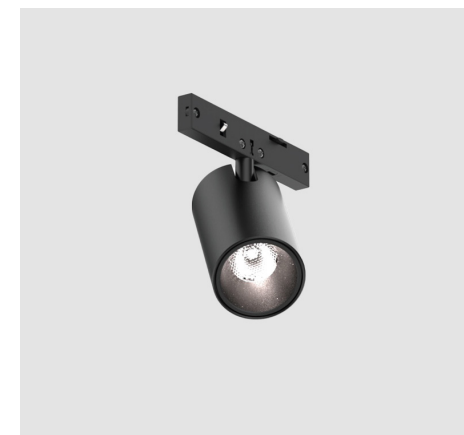

Imagine



Invader

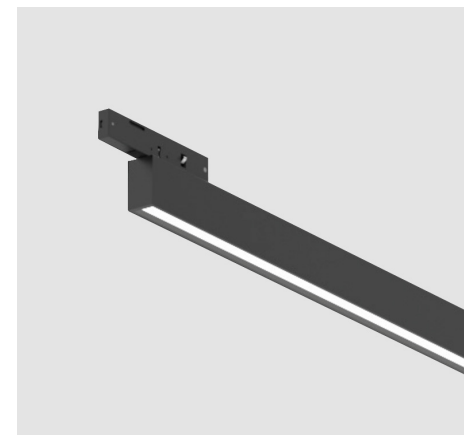
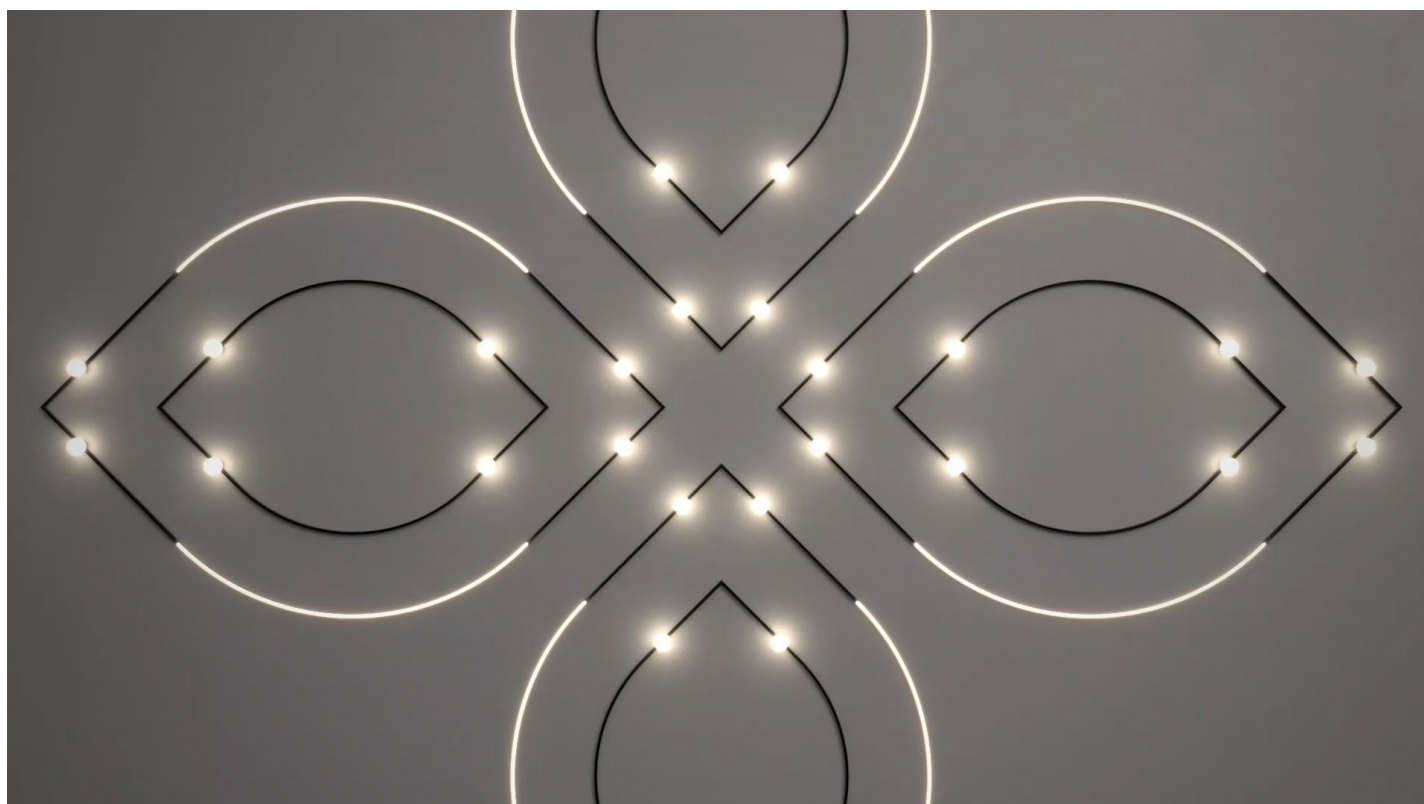

LEDline



Magiq



Sign

# Level

A versatile cable-based lighting system designed for spaces where traditional ceiling installations aren't feasible, such as glass ceilings or heritage structures.

- Spans up to 10 m, mountable wall-to-wall or wall-to-ceiling
- Tool-free installation and easy reconfiguration
- Direct or indirect inserts with refined optics for ambient or task lighting



# Level

## Inserts



Level - Mini - Adjustable Spot



Level - Mini - Fixed Diffuser



Level - Mini - Fixed Spot



Level - Mini - Suspension



Level - Studio



Level - Studio - Suspension



Level - Zoom Adjustable Spot



Level - Zoom - Fixed Spot



Level - Zoom - Suspension

# Minimal Track

An ultra-compact low voltage system, only 9.5 mm high and 19 mm wide, blending seamlessly into architectural spaces while delivering powerful functionality in a nearly invisible form.

- Over 25 finish options with color-coordinated inserts and accessories
- Wide selection of inserts, from pendants to spotlights to indirect lighting
- Elegant light paths without compromising architectural vision



# Minimal Track



The flexible track cover and optional black rubber insert for curves further enhance the system's ability to disappear into architecture.

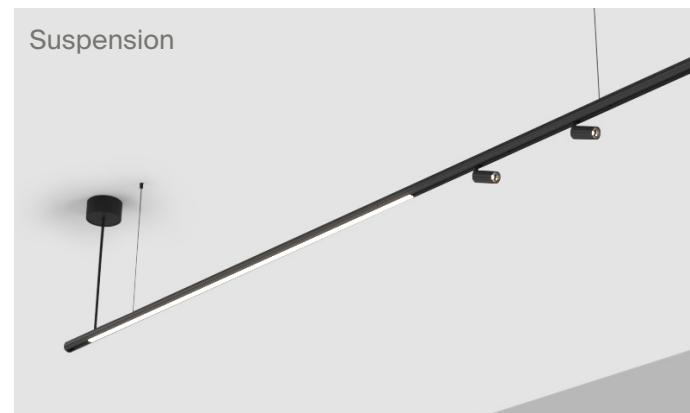

## Inserts

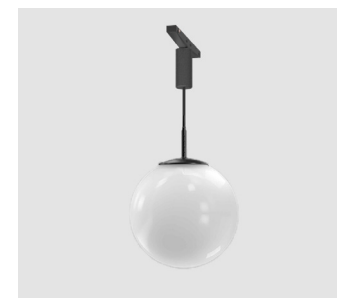

Bilo



Imagine Micro

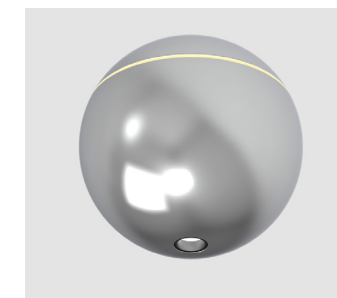

Snooker



Magiq Micro

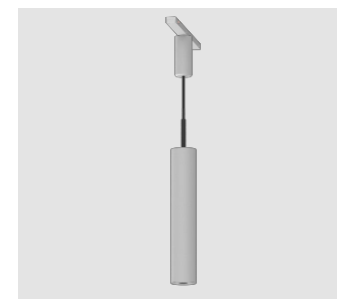

Hangover



Microline

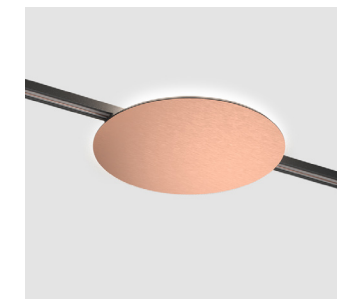

Disq Round

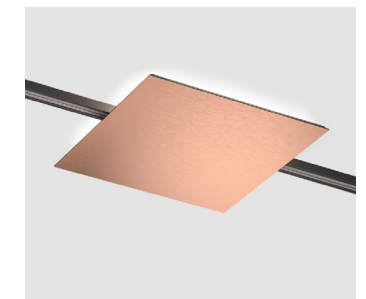

Disq Square

# Viavai

A refined 48V low-voltage linear system that combines sleek aesthetics with functional track lighting, offering both direct and indirect illumination.

- Continuous light without dark spots
- Snap system for easy installation and reconfiguration
- Versatile inserts for customizable designs and discreet integration



# Viavai

## Inserts



Bob



Mini Adjustable



Mini fixed



Mini Suspension



Zoom Adjustable



Zoom Fixed

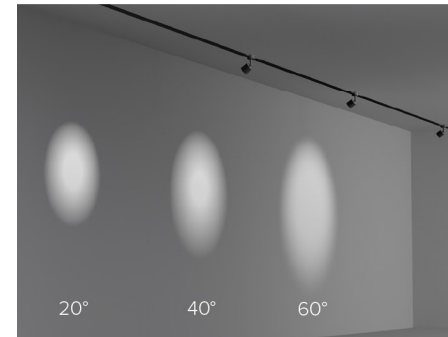

Zoom with its rotating zoom optic allows endless beams from 12 to 46 degrees.



Zoom Suspension

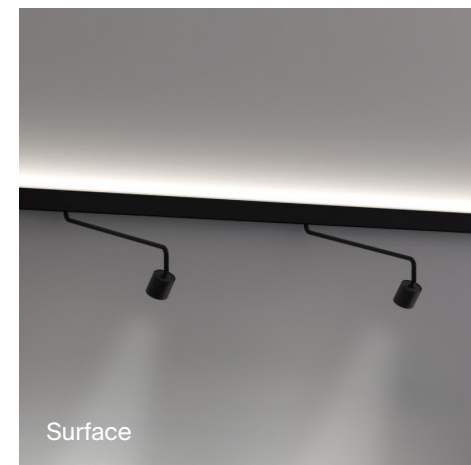

Surface

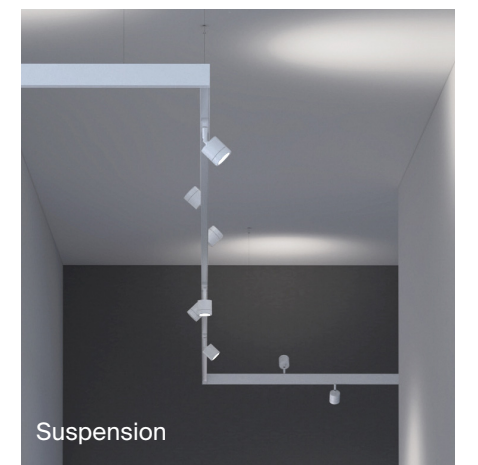

Suspension

# Track Lights



# Track Lights

Our track systems feature refined spotlights and wallwashers that combine performance, comfort, and seamless architectural integration.

Offering adjustable beam angles, tunable white options, and discreet drivers, they simplify installation while delivering powerful, aesthetic lighting for art, retail, and large commercial spaces.



# Centriq

Delivers powerful, precise lighting with a minimalist design, making it ideal for modern track systems where both performance and discretion are critical.

- Exact Positioning System (EPS) with secure fixation and 10° rotational adjustments (audible click)
- Available in 65 mm and 83 mm diameters with beam angles from 10° to 54°
- Delivers up to 4200 lumens with options like Tunable White LEDs for retail, gallery, hospitality and beyond



# Centriq



Centriq



Centriq for Clicktrack



Centriq In



Centriq In Flex



Centriq Wallwash



Centriq Small

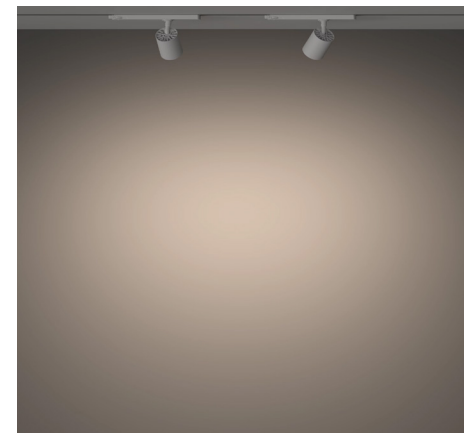

Centriq In Flex

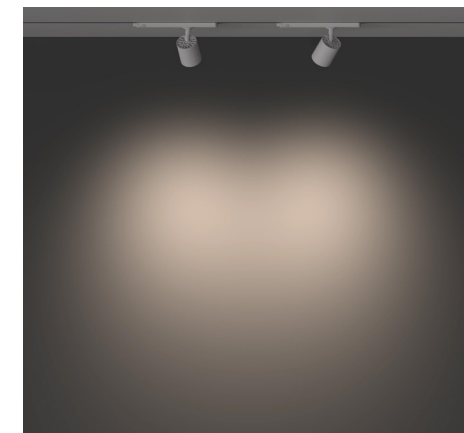

Centriq In Flex

The Centriq In Flex version offers manual beam angle adjustments from 12° to 45° for versatile lighting control.

# Imagine

Delivers powerful, targeted illumination with maximum flexibility, all in a discreet design that blends seamlessly into architectural spaces. Ideal for dynamic environments like retail and museums where lighting needs often shift.

- Flex system with beam angles from 14° to 48°
- 350° rotation and 90° tilt through articulated arm
- Integrated DALI-dimmable driver for clean lines and easy installation

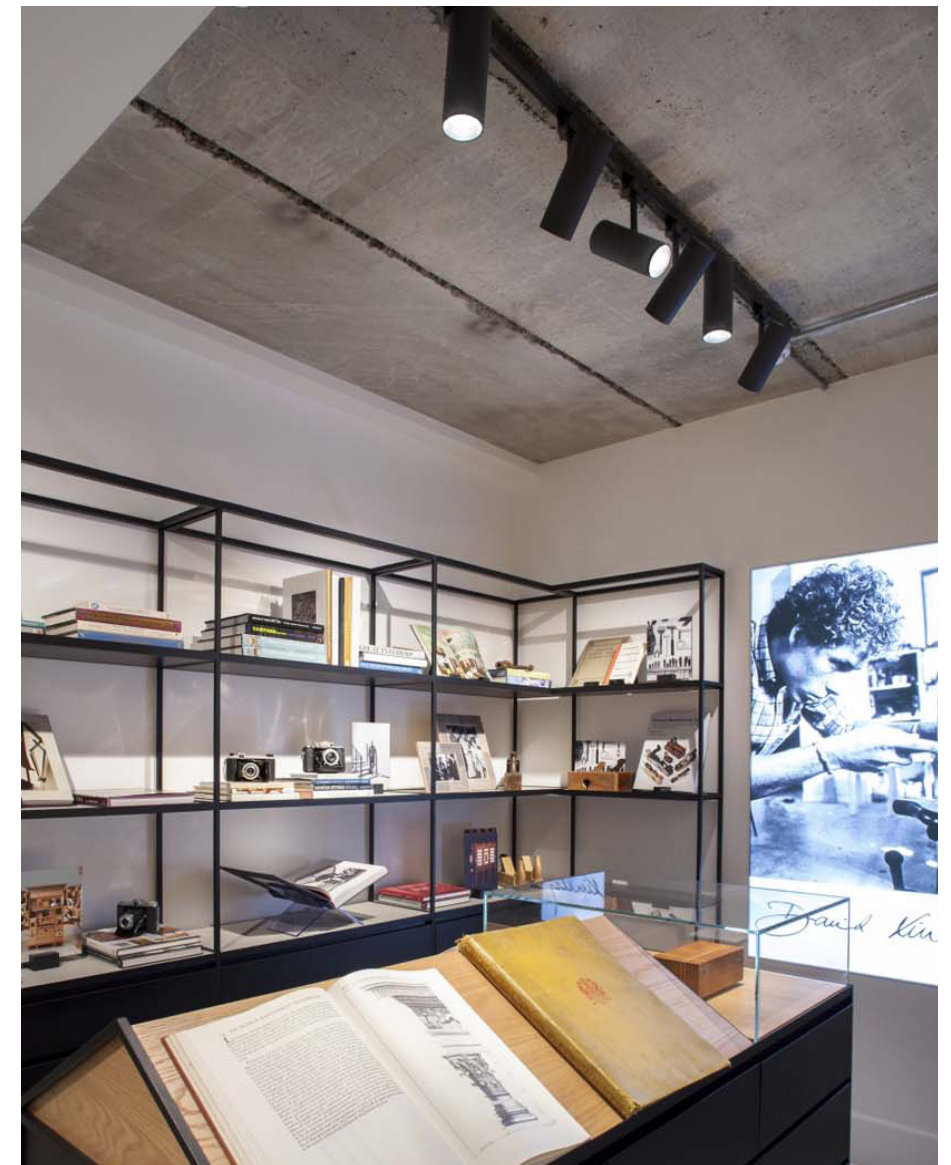

# Imagine



Imagine

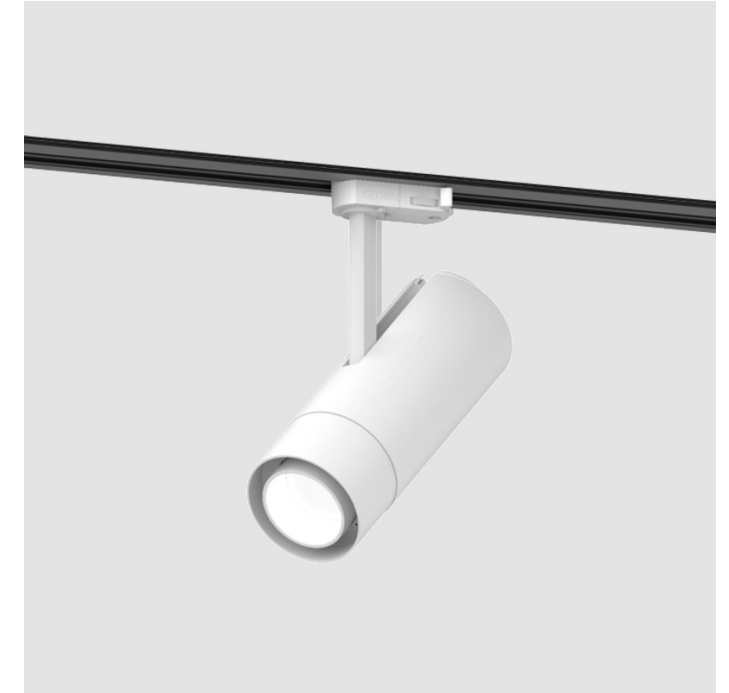

Imagine Flex

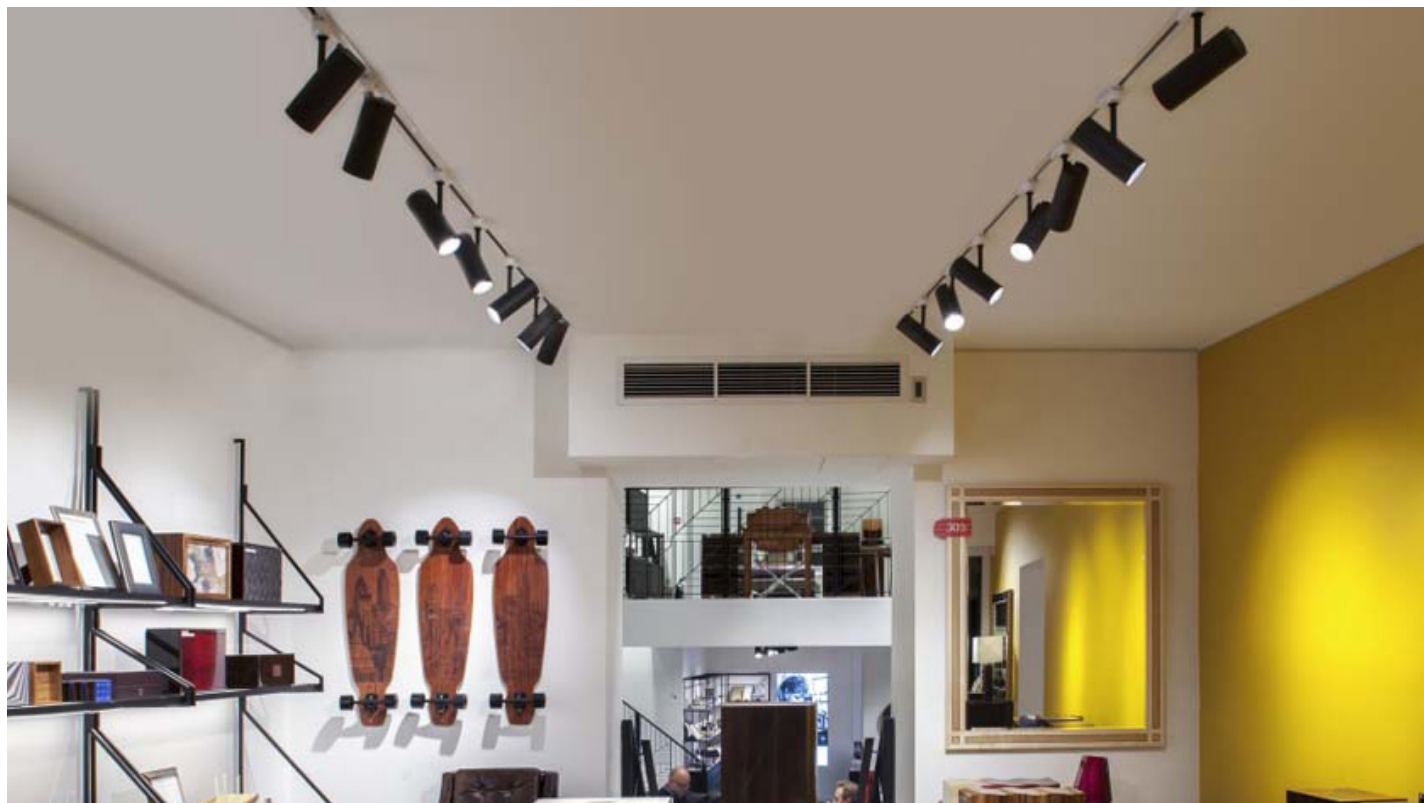

A flawless transition of the beam angle of the Imagine Flex between 14° (inner cone) and 48° (outer cone).



# Magiq Wallwash

Delivers maximum wall uniformity and clarity with advanced reflector technology, ensuring powerful, glare-free vertical illumination.

- Precisely calculated reflectors for controlled direction and a square beam with no multiple shadows
- Eliminates reflections on glass or screens, enhancing comfort in workspaces and display areas
- Optimized LED efficiency for high performance without waste

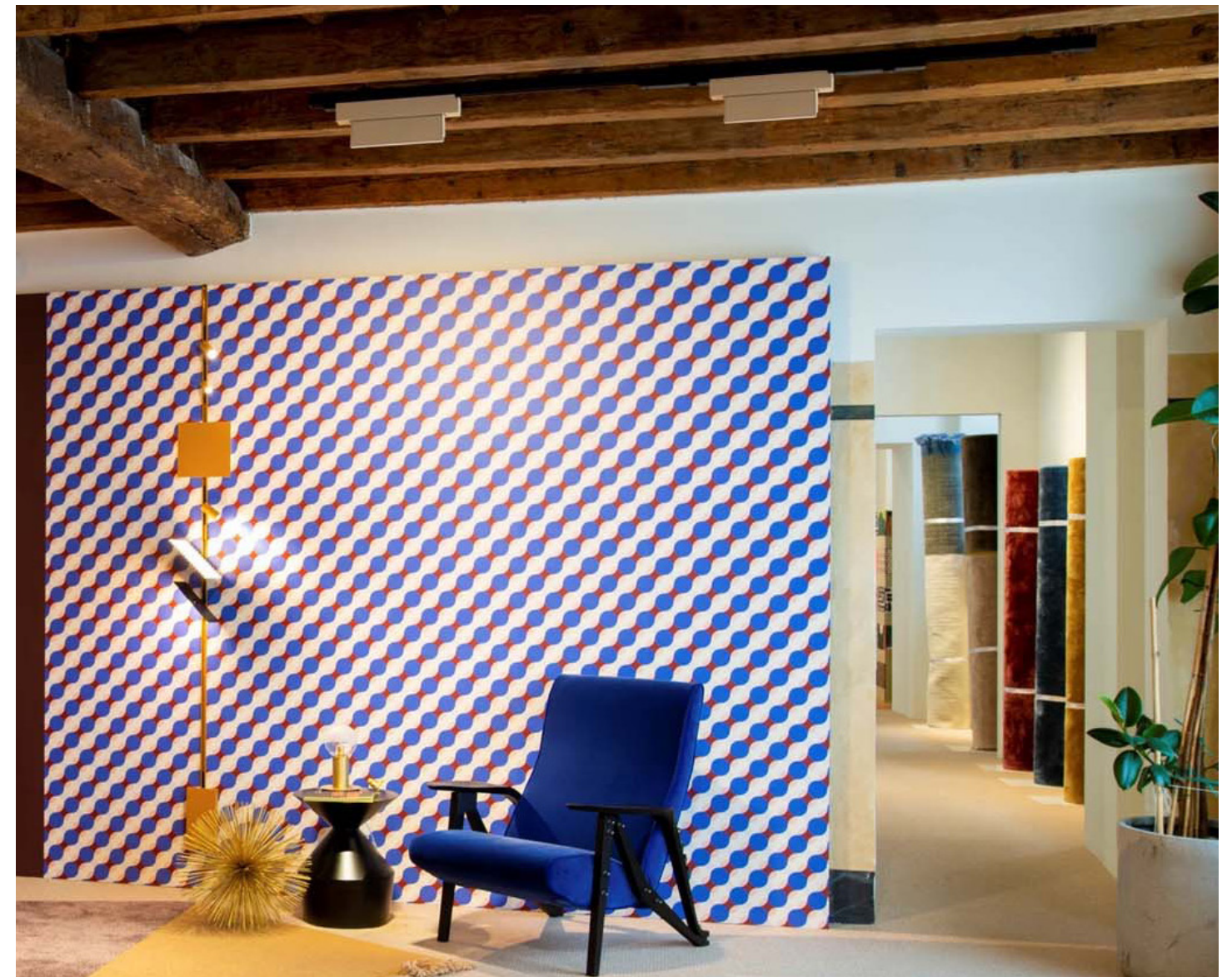

# Magiq Wallwash



Magiq Wallwash Plus - White Adapter



Magiq Wallwash Plus - Black Adapter

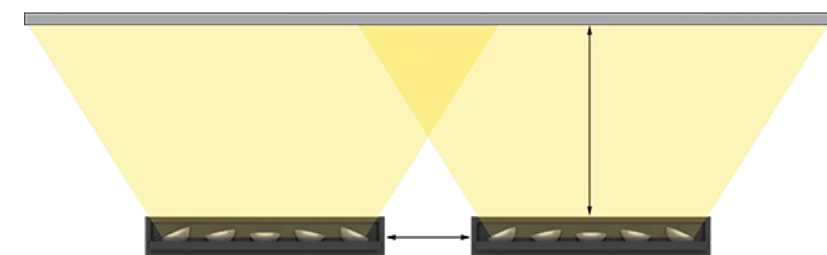

Ideal for architectural settings like offices, galleries, and retail spaces, this high-performance wallwasher delivers light even up to 4.5 meters high.

The Vertical Boost feature maintains consistent illumination on tall walls, while the spoon reflector maximizes light output and beam clarity.

# Oiko Pro In

Delivers precision lighting with advanced optics that ensure clean beam angles, consistent quality, and exceptional visual comfort.

- Tunable White technology with real-time color adjustment, up to 2000 lumens glare-free
- Compact design with integrated adapter and driver, maintaining clean lines and eliminating clutter
- Wallwash version functions as both downlight and wallwasher, minimizing reflections and glare for high-visibility displays



# Oiko Pro In



Oiko Pro In



Oiko Pro In Wallwash

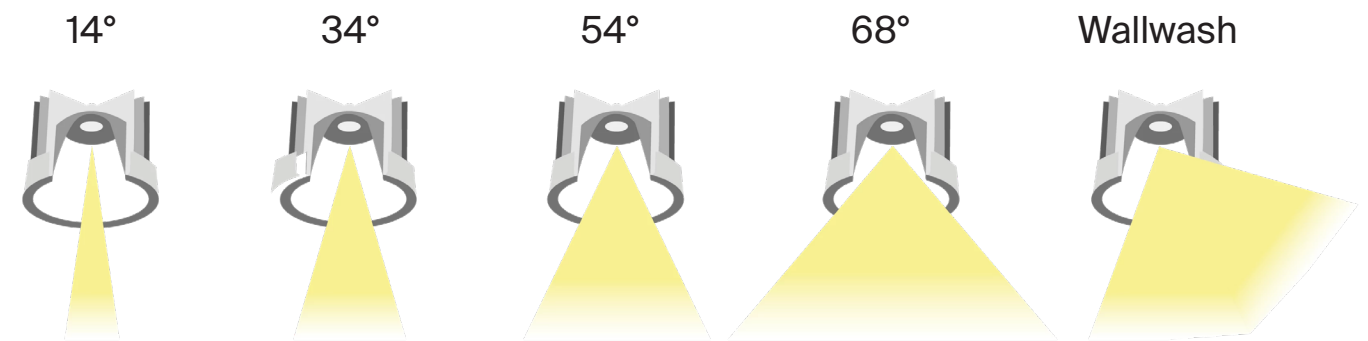

Compatible with various 3-phase track systems, it offers beam angles of 14°, 34°, 52°, 68°, and a specialized wallwash optic.

## Expert Collaboration

Working with Zaneen means more than choosing advanced lighting systems. It's gaining a partner fully committed to your project's success. Our team provides expertise, tailored support, and reliable execution to bring your lighting vision to life with precision and excellence.

Our architectural track systems combine flexibility, intuitive installation, and seamless integration, giving designers powerful tools to shape light with clarity, efficiency, and purpose.

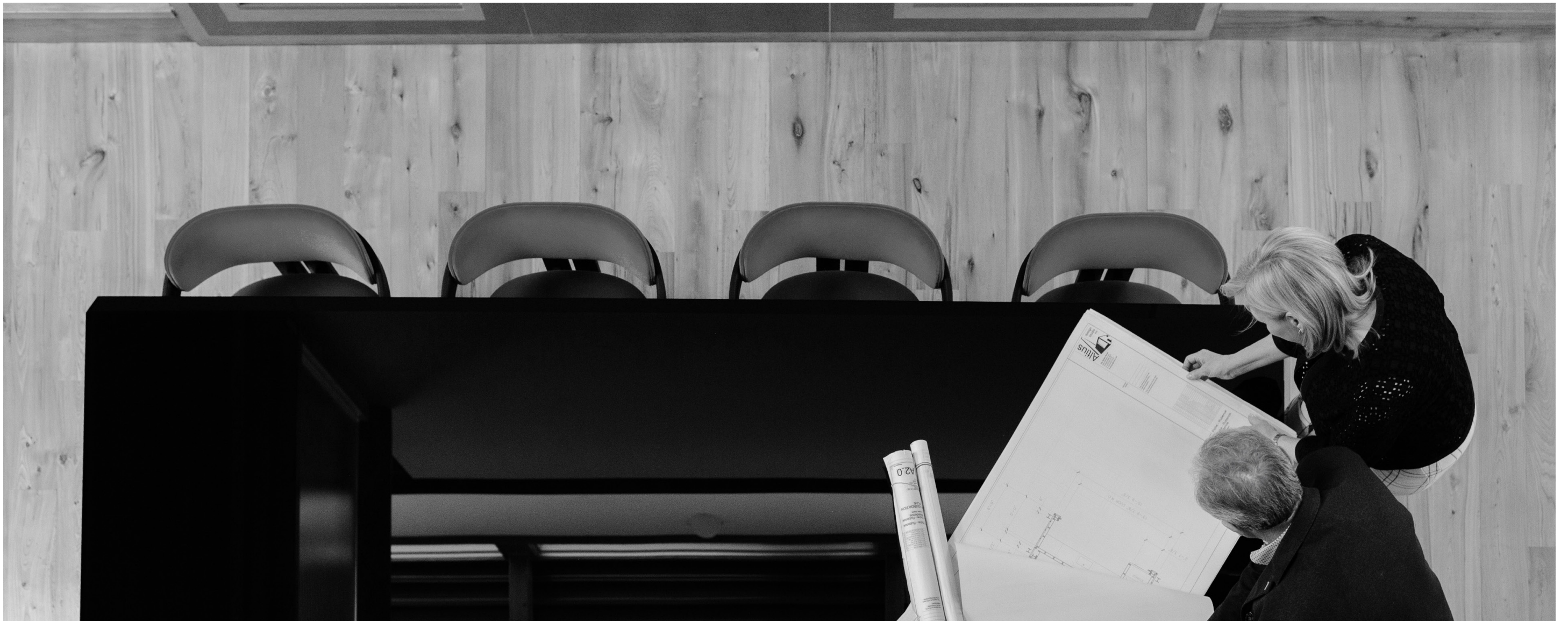

# ZANEEN

Internationally recognized North American provider of premium European lighting, offering innovative solutions across four divisions.

Projects

Inspiration

For more information, please contact Zaneen or your local representative.

zteam@zaneen.com  
T 1-800-388-3382

● ARCHITECTURAL  
Innovative solutions for precision lighting.

Products

● DESIGN  
Extensive range of material, form and style.

Products

● EXTERIOR  
Cutting-edge technology meets craftsmanship.

Products

● CUSTOM  
Crafting bespoke luminaires with expertise.

About